

岩崎通信機株式会社



IWATSU ELECTRIC CO., LTD.

International Department:

Yanagiya-Building 1-10, 2-chome Nihonbashi,
Chuo-ku, Tokyo, 103 Japan

Telephone: Tokyo 03-3274-7751

Facsimile: Tokyo 03-3274-7748

Telex: J24225 (TELEIWA)

Cable Address: TELEIWATSU

Cautions

Observe the following precautions in operating the DS-6121/DS-6121A.

Ambient temperature and ventilation

The DS-6121/DS-6121A operates normally in the ambient temperature range of 0°C to +40°C. Be sure to use the DS-6121/DS-6121A within this range. Use of it outrange can result in some trouble. Do not place anything near the ventilating holes in the cover

Line voltage check

The DS-6121/DS-6121A can be used on 90 V to 250 V.

Before connecting the power cord to a electrical outlet, be sure to check line voltage.

Use the supplied power cord.

Use the supplied 3-core power cord.

When operating the DS-6121/DS-6121A on the line voltage from a 2-core electrical outlet with the supplied 3-core power cord and a conversion adaptor, be sure to ground the protective ground terminal on the rear panel to prevent danger.

Use the Proper Fuse

To avoid fire hazard, use only a fuse of the correct type, voltage rating and current rating as specified (3 A/250 V slow-blow).

Before replacing the fuse, be sure to disconnect the power cord from the electrical outlet.

Do not Operate in Explosive Atmospheres

To avoid explosion, do not operate the DS-6121/DS-6121A in an explosive atmosphere.

Do not apply excessive voltage

The input voltage limit of each input connector is as follows:

CH1-2 INPUT	±250 V MAX.
EXT TRIO INPUT	±250 V MAX.
EXT CLOCK INPUT	±50 V MAX.

Do not increase intensity excessively

Do not increase the intensity of traces or spot more than necessary. Excessive intensity can not only result in eyes fatigue, but if left for a long time, it will burn the CRT phosphor surface.

Using the DS-6121/DS-6121A with the CRT screen up

The DS-6121/DS-6121A can be used with the CRT screen up as shown in figure 1. When used in this position, be careful not to make the DS-6121/DS-6121A fall down by pulling hard on the probes connected to the signal input connector.

Figure 1. The CRT Screen Up

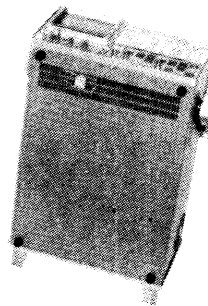

Observing the Signal Floating from Grounding

The chassis is always grounded. So, if the ground terminal, etc. of the probe linked with the chassis is connected to a signal source by mistake, it will cause a trouble or damage with the instrument and the external equipment (including a personal computer, a miniature computer or a plotter connected to the instrument through the interface cable).

When observing a signal floating over the ground, be sure to adopt the differential input system (V mode and CH2 POLAR set to ADD and INV respectively, and two probes or two coaxial cables used).

Figure 1. Observation Example by Differential Method

[Good Example]

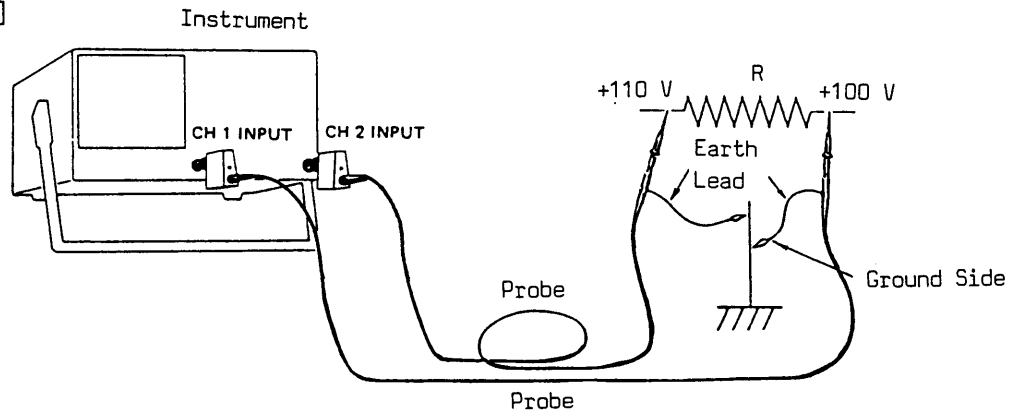

[Bad Example]

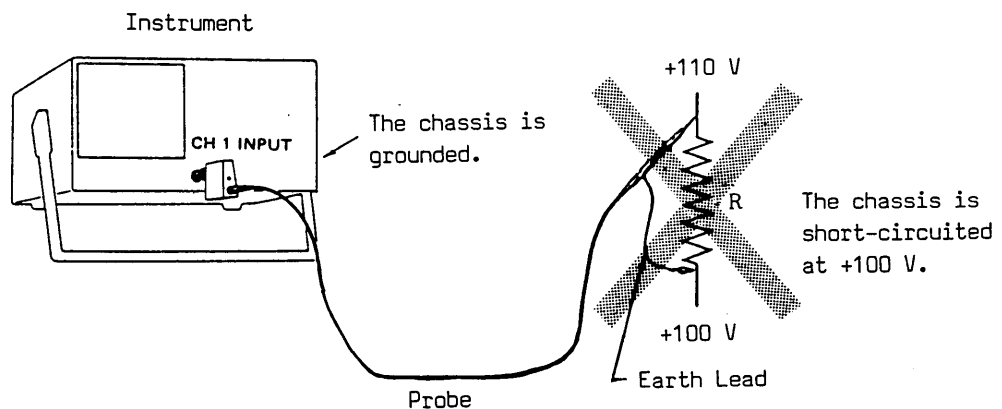

TABLE OF CONTENTS

CAUTIONS	iii
SECTION 1 SPECIFICATIONS	1 - 1
1-1 GENERAL	1 - 1
1-2 ELECTRICAL SPECIFICATIONS	1 - 1
1-2-1 Vertical Deflection System (Channel 1 and 2)	1 - 1
1-2-1-1 Nonstorage (Real)	1 - 1
1-2-1-2 Storage	1 - 1
1-2-2 Triggering	1 - 2
1-2-3 Horizontal Deflection System	1 - 3
1-2-3-1 Nonstorage (Real)	1 - 3
1-2-3-2 Storage	1 - 3
1-2-4 X-Y Operation	1 - 4
1-2-4-1 Nonstorage (Real)	1 - 4
1-2-4-2 Storage	1 - 4
1-2-5 Z-axis	1 - 4
1-2-6 CRT Read Out and Cursor Measurement	1 - 4
1-2-7 CRT Display	1 - 4
1-2-8 Set Up Function	1 - 5
1-2-9 Digital Storage	1 - 5
1-2-10 Single Output	1 - 6
1-2-10-1 Nonstorage (Real)	1 - 6
1-2-10-2 Storage	1 - 6
1-2-11 Battery Back Up	1 - 6
1-2-12 Power Supply	1 - 7
1-3 DIMENSIONS AND WEIGHT	1 - 7
1-4 ENVIRONMENTAL CHARACTERISTICS	1 - 8
1-5 ACCESSORIES	1 - 8
SECTION 2 CONTROLS, CONNECTORS AND INDICATORS	2 - 1
2-1 FRONT PANEL	2 - 1
2-1-1 Power and Display	2 - 2
2-1-2 Vertical Deflection System	2 - 4
2-1-3 TRIGGERING	2 - 6
2-1-4 Horizontal System	2 - 8
2-1-5 STORAGE, GUIDE MENU and Others	2 - 10
2-2 REAR PANEL	2 - 12
2-3 BOTTOM	2 - 14
2-4 READOUT	2 - 15
2-4-1 Display of Setting Control Values from Panel	2 - 15
2-4-2 Display of REF	2 - 16
2-4-3 Cursor Measurement Value Display	2 - 16
2-4-4 Guide Menu Display	2 - 17
2-5 OPERATION OF THE HANDLE AND REMOVAL OF THE ACCESSORIES BAG	2 - 18
2-5-1 Operation of the Handle	2 - 18
2-5-2 Removal of the Accessories Bag	2 - 18

TABLE OF CONTENTS (Continued)

— DS-6121 —

SECTION 3 OPERATING INFORMATION	3 - 1
3-1 POWER TURNING-ON AND CHECK OF INITIAL STATE	3 - 4
3-2 VERTICAL DEFLECTION SYSTEM	3 - 6
3-3 TRIGGERING	3 - 10
3-4 HORIZONTAL SYSTEM	3 - 16
3-5 STORAGE	3 - 21
3-6 X-Y OPERATION	3 - 24
3-7 GUIDE MENU	3 - 26
3-7-1 MEASUREMENT BY CURSORS	3 - 30
3-7-1-1 Δ VOLTAGE	3 - 32
3-7-1-2 VOLTAGE RATIO	3 - 33
3-7-1-3 Δ TIME	3 - 34
3-7-1-4 PHASE	3 - 35
3-7-1-5 Δ V ON WAVEFORM	3 - 36
3-7-2 SETUP RECALL/SAVE	3 - 37
3-7-2-1 SAVE	3 - 38
3-7-2-2 RECALL	3 - 40
3-7-3 WAVEFORM RECALL/SAVE	3 - 42
3-7-2-1 SAVE	3 - 42
3-7-2-2 RECALL	3 - 44
3-7-3-3 MOVE	3 - 46
3-7-4 AVERAGING	3 - 48
3-7-5 EQU-SAMPLING	3 - 50
3-7-6 CURVE INTERPOLATION	3 - 51
3-7-7 + - X	3 - 52
3-7-8 GO/NO GO	3 - 54
3-7-8-1 CURSORS	3 - 56
3-7-8-2 WAVEFORMS	3 - 58
3-7-9 WAVEFORM OUT	3 - 60

TABLE OF CONTENTS (Continued)

—DS-6121A—

SECTION 3 OPERATING INFORMATION	3 - 1
3-1 POWER TUNING-ON AND CHECK OF INITIAL STATE	3 - 4
3-2 VERTICAL DEFLECTION SYSTEM	3 - 6
3-3 TRIGGERING	3 - 10
3-4 HORIZONTAL SYSTEM	3 - 16
3-5 STORAGE	3 - 21
3-6 X-Y OPERATION	3 - 64
3-7 GUIDE MENU	3 - 66
3-7-1 MEASUREMENT BY CURSORS	3 - 70
3-7-1-1 Δ VOLTAGE	3 - 72
3-7-1-2 VOLTAGE RATIO	3 - 73
3-7-1-3 Δ TIME	3 - 74
3-7-1-4 PHASE	3 - 75
3-7-1-5 Δ V ON WAVEFORM	3 - 76
3-7-2 SETUP RECALL/SAVE	3 - 77
3-7-2-1 SAVE	3 - 78
3-7-2-2 RECALL	3 - 80
3-7-3 WAVEFORM RECALL/SAVE	3 - 82
3-7-2-1 SAVE	3 - 82
3-7-2-2 RECALL	3 - 84
3-7-3-3 MOVE	3 - 86
3-7-4 AVERAGING	3 - 88
3-7-5 ENVELOPING	3 - 90
3-7-6 EQU-SAMPLING	3 - 94
3-7-7 CURVE INTERPOLATION	3 - 95
3-7-8 + - X	3 - 96
3-7-9 GO/NO GO	3 - 98
3-7-9-1 CURSORS	3 -100
3-7-9-2 WAVEFORMS	3 -102
3-7-10 WAVEFORM OUT	3 -104
3-8 ADJUSTMENT OF CURSOR AND TRACE POSITIONS	3 -109
3-8-1 Preparation	3 -109
3-8-2 Vertical Position	3 -109
3-8-3 Adjustment of Horizontal Position	3 -109
GLOSSARY	3 -111

TABLE OF CONTENTS (Continued)

SECTION 4 GP-IB INTERFACE (OPTION)	4 - 1
4-1 GENERAL	4 - 1
4-1-1 Specifications of GP-IB	4 - 1
4-1-2 Construction	4 - 2
4-1-3 Function Subsets	4 - 2
4-1-4 Signal Line and Number of Connector Pin	4 - 2
4-2 ADDRESSING	4 - 4
4-2-1 ADDRESS Setting (2^0 , 2^1 , 2^2 , 2^3 , 2^4)	4 - 4
4-2-2 DELIMITER Setting	4 - 4
4-2-3 TALK ONLY Setting	4 - 4
4-3 FUNCTION	4 - 6
4-3-1 Outline	4 - 6
4-3-2 Data Transmission	4 - 6
4-3-3 Panel Operations	4 - 8
4-3-4 Status Output	4 - 8
4-3-5 Control Message Responses	4 - 9
4-4 DETAILS OF GP-IB COMMANDS	4 - 10
4-4-1 Waveform Data Read Command	4 - 10
4-4-2 Waveform Data Write Command	4 - 12
4-4-3 Individual Panel Operation	4 - 17
4-5 OPERATING PROCEDURES	4 - 26
4-6 PROGRAM FLOW OF THE DS-6121 BY THE CONTROLLER	4 - 28
4-7 SAMPLE PROGRAM	4 - 30
4-7-1 PC-9801	4 - 30
4-7-2 HP-216	4 - 36
SECTION 5 RS-232-C INTERFACE (OPTION)	5 - 1
5-1 GENERAL	5 - 1
5-1-1 Specifications of RS-232-C	5 - 1
5-1-2 Construction	5 - 2
5-1-3 Signal Line and the Number of Connection Pin	5 - 2
5-1-4 Connection to External Equipments	5 - 4
5-1-5 Character Format, Handshake and Echo-back Process Character Format	5 - 6
5-2 SETTING OF SWITCHES	5 - 8
5-2-1 Setting of Switch 1	5 - 8
5-2-2 Setting of Switch 2 (Delimiter)	5 - 8
5-3 FUNCTION	5 - 10
5-3-1 Outline	5 - 10
5-3-2 Data Transmission	5 - 10
5-3-3 Panel Operations	5 - 11
5-4 DETAILS OF RS-232-C COMMANDS	5 - 12
5-4-1 Waveform Data Read Command	5 - 12
5-4-2 Waveform Data Write Command	5 - 14
5-4-3 Individual Panel Operations	5 - 19
5-4-3-1 Operations other than Remote/Local	5 - 19
5-4-3-2 Remote/Local	5 - 19
5-5 OPERATION	5 - 19
5-6 PROGRAM FLOW OF THE DS-6121 BY THE CONTROLLER	5 - 20
5-7 SAMPLE PROGRAM	5 - 22
5-7-1 PC-9801	5 - 24
5-7-2 HP-216	5 - 30

Section 1 Specifications

1-1 GENERAL

The DS-6121/DS-6121A is an easy-to-use, high-grade oscilloscope with digital storage mode and equivalent sampling function, suitable for multiple purposes and a wide range of applications.

The DS-6121/DS-6121A may also be used as a programmable oscilloscope using a personal computer as a controller via the GP-IB or RS-232-C interface for research and development purposes, and also can increase the efficiency of production and inspection lines.

1-2 ELECTRICAL SPECIFICATIONS

1-2-1 Vertical Deflection System (Channels 1 and 2)

Deflection factor	
Range	1 mV/div to 5 V/div in a 1-2-5 sequence of 12 steps 1 mV/div to 12.5 V/div, continuously variable with the VARIABLE
Accuracy I	2% at 5 mV to 5 V (10°C to 35°C) 4% at 1 mV and 2 mV (10°C to 35°C)
Accuracy II	5% at 5 mV to 5 V (0°C to 40°C) 8% at 1 mV and 2 mV (0°C to 40°C)
Input RC	Direct: 1 M Ω \pm 1.5%/25 pF \pm 2 pF With probe: 10 M Ω \pm 2%/14 pF \pm 2 pF
Maximum input voltage	\pm 250 V MAX
Input coupling	AC, DC, GND
Common mode rejection ratio	50:1 (1 kHz sine wave)
Inversion	CH 2 only

1-2-1-1 Nonstorage (Real)

Frequency response	
Bandwidth	5 mV/div to 2 V/div DC to 100 MHz -3 dB (10°C to 35°C) 1 mV/div, 2 mV/div DC to 50 MHz -3 dB (10°C to 35°C) 5 V/div DC to 100 MHz -3.5 dB (10°C to 35°C)
AC coupled low	-3 dB Point 4 Hz
Rise time	Approximately 3.5 ns at 10 mV/div
Vertical mode	CH 1, CH 2, ALT, CHOP (switching rate: approximately 500 kHz), ADD

1-2-1-2 Storage

Frequency response	
One shot	
Curve interpolation OFF	DC to 10 MHz (1-channel operation) DC to 5 MHz (2-channel operation)
Equivalent sampling	DC to 100 MHz (10°C to 35°C)
Envelope (DS-6121A)	DC to 10 MHz -3 dB (10°C to 35°C)
Vertical mode	CH 1, CH 2, CH 1 & CH 2, CH 1 CH 2 & REF

1-2-2 Triggering**A TRIGGER**

Sensitivity

Maximum trigger level (10°C to 35°C)

Frequency Range	Level	
	CH 1, CH 2	EXT
DC to 10 MHz	0.4 div	0.1 V
Up to 50 MHz	1.0 div	0.1 V
Up to 100 MHz	1.5 div	0.1 V

<Note>

- Trigger signals are attenuated in the following frequency ranges depending on coupling
AC 100 Hz or lower
HF REJ 10 kHz or higher
LF REJ 10 kHz or lower
- Auto sweep mode: The lower usable frequency is 50 Hz
- TV-V, TV-H synchronizing signal level: 1 div or more on screen amplitude for a composite video signal composed of 7 parts video signal and 3 parts synchronizing signal

Source

CH 1, CH 2, EXT, NORM, LINE

AC, DC, HF REJ, LF REJ, TV-V

Slope

+, -

External trigger input

Maximum input voltage ±250 V MAX

Input RC

1 MΩ ± 3%/25 pF ± 5% (Both A and B COUPLINGS are DC)

1.2 MΩ ± 3%/25 pF ± 5% (Either A or B COUPLING is DC)

1.5 MΩ ± 3%/25 pF ± 5% (Neither A nor B COUPLING is DC)

B TRIGGER

Minimum trigger level

Same as in A .TRIGGER Table

Source

RUN AFTER DELAY, CH 1, CH 2, EXT

Coupling

AC, DC, HF REJ, TV-H

Slope

+, -

External trigger input

Same as A TRIGGER

1-2-3 Horizontal Deflection System

Sweep mode	AUTO, NORM, SINGLE
Sweep magnification	10 times
Accuracy I (Over center 8 divisions)	20 nsec/div and 50 nsec/div 6% (10°C to 35°C) 0.1 sec/div to 0.1 sec/div 3% (10°C to 35°C)
Accuracy II (Over center 8 divisions)	20 nsec/div and 50 nsec/div 7% (0°C to 40°C) 0.1 sec/div to 0.1 sec/div 5% (0°C to 40°C)
Holdoff time	Continuously variable

1-2-3-1 Nonstorage (Real)

HORIZ DISPLAY	A, A INTEN, A INTEN & B (DLY'D), B (DLY'D), X-Y
A SWEEP	
Sweep time	20 ns/div to 0.1 s/div in a 1-2-5 sequence of 21 steps
Accuracy I (Over center 8 divisions)	2% (10°C to 35°C)
Accuracy II (Over center 8 divisions)	4% (0°C to 40°C)
Roll mode	0.2 s/div to 10 s/div
B SWEEP	
Delay	
Triggered delay	CH 1, CH 2, EXT
Continuous delay	RUN AFTER DELAY
Sweep time	20 ns/div to 0.1 s/div in a 1-2-5 sequence of 21 steps
Accuracy I (Over center 8 divisions)	2% (0°C to 40°C)
Accuracy II (Over center 8 divisions)	4% (0°C to 40°C)
Delay jitter	1/10,000 or less

1-2-3-2 Storage

HORIZ DISPLAY	A, A INTEN, B (DLY'D), X-Y
A Sweep Time	
Single shot	20 ns/div to 10 s/div and EXT
Equivalent sampling	
1 channel	20 ns/div to 2 μ s/div
2 channels	20 ns/div to 5 μ s/div
B Sweep Time	Same as Nonstorage

1-2-4 X-Y Operation

1-2-4-1 Nonstorage (Real)

X AXIS	
Input connector	CH 1
Deflection factor	Sams as that of CH 1
Bandwidth	DC to 2 MHz
Y AXIS	
Input connector	CH 2
Deflection factor	Same as that of CH 2
Bandwidth	Same as that of CH 2
X-Y Phase Defference	3° or less (DC to 100 kHz)

1-2-4-2 Storage

X axis	CH 1 or REF 1
Y axis	CH 2 or REF 2

1-2-5 Z-axis

Sensitivity	0.5 V _{p-p} or more
Slope	Positive-going signal decreases intensity
Bandwidth	DC to 5 MHz
Input resistance	10 k Ω \pm 20%
Maximum input voltage	\pm 50 V MAX

1-2-6 CRT Read Out and Cursor Measurements

CRT read out	The following parameters are displayed CH 1 deflection factor, CH 2 deflector factor A trigger level, B trigger level A SWEEP time, B SWEEP time, DELAY TIME MULTI, HOLDOFF time (%) REF 1 deflection factor, REF 2 deflection factor Various modes (Intplting, Equ-sampling, etc.)
Cursor measurements	Voltage measurement Voltage ratio (displayed in dB and %) Time measurement Phase measurement Voltage on waveform measurement
Error of cursor reading to CRT reading	Voltage measurement (when the cursors locate over center 6 divisions): \pm 3% or less (10°C to 35°C) Time measurement (when the cursors locate over center 8 divisions): \pm 3% or less (10°C to 35°C)

1-2-7 CRT Display

Shape	Rectangular, 6 inches
Display area	8 div \times 10 div (1 div = 10 mm)
Phosphor	B31
Accelerating voltage	Approximately 20 kV

1-2-8 Set Up Function

No. of memories	4
Kinds	Set up memory 4 Set up in the state of power OFF Set up in the state of final waveform capture before power OFF (Valid for STORAGE only) Default

1-2-9 Digital Storage

A/D converter	
Resolution	8 bits, 25 levels/div
Maximum clock rate	1 channel operation: 40 MHz 2 channel operation: 20 MHz Enveloping : 4 MHz
Memories	
Capture memory	2048 words × 2 channels
Display memory	512 words × 4 traces
No. of waveforms that can be saved	4
No. of averagings	2, 4, 8, 16, 32, 64, 128, 256
Interpolation function	Curve interpolation Step interpolation Vector interpolation for displayed waveform
Calculation functions	CH 1 + CH 2 CH 1 - CH 2 CH 1 × CH 2
GO/NO GO judgement	
Area setting	4 cursors 2 waveforms and 2 cursors In addition, IN and OUT ranges can be selected; FREEZE IF NO GO or CONTINUE can be selected.
Waveform output	
X-Y recorder	Automatically draws scales
Plotter	Automatically draws scales and settings with GP-IB or RS-232-C interface pack Iwatsu format:SR-6620, SR-6602 or SR-6625 HP-GL format:SR-6620H, HP-7440A, HP-7470A or HP-7475A
Waveform enlarging	
Vertical	× 1/10 to × 10
Horizontal	× 1 to × 100
Data positions	FULL POST (Delay 0) POST (Delay -1/8) CENTER (Delay -1/2) PRE (Delay -7/8)
Difference between real and storage trace positions	Equivalent sampling: ±0.9 div or less (10°C to 35°C) Envelope : ±0.9 div or less (10°C to 35°C) Others : ±0.7 div or less (10°C to 35°C)

1-2-10 Single Output

Calibrators

Output voltage	0.6 V
Accuracy I	1% (10°C to 35°C)
Accuracy II	1.5% (0°C to 40°C)
Waveform	Square wave
Repetition frequency	1 kHz
Accuracy I	1% (10°C to 35°C)
Accuracy II	1.5% (0°C to 40°C)
Output current	10 mA
Accuracy I	1.5% (10°C to 35°C)
Accuracy II	2% (0°C to 40°C)

1-2-10-1 Nonstorage (Real).

CH 1 signal output	
Output voltage	30 mV $\pm 20\%$ per division of displayed signal (with 50 Ω load)
Frequency response	DC to 50 MHz -3 dB
Output resistance	50 Ω $\pm 20\%$
A gate output	
Output voltage	Approximately ± 5 V (reference voltage: About 0 V)
Output resistance	Approximately 2.7 k Ω
B gate output	Same as A gate output

1-2-10-2 Storage

Pen recorder output	
PEN Y signal output	
Output voltage	Approximately 0.2 V $\pm 10\%$ (with 1 M Ω load) per division of displayed signal
Output resistance	1.1 k Ω $\pm 20\%$
Difference between CRT and recorder readings	± 0.5 div. or less (10°C to 35°C)
PEN X signal output	Same as Y signal output
PEN UP/DOWN output	
Output voltage	Approximately +5 V (reference voltage: About 0 V)
Output resistance	600 Ω $\pm 20\%$ at 0 V 2.9 k Ω $\pm 20\%$ at 0 V
Plotter output	
Difference between CRT and plotter readings	± 0.5 div. or less (10°C to 35°C)
Plotting width error per 1 div. or CRT	$\pm 5\%$ (10°C to 35°C)
GO/NO GO judgement output	
Output voltage	Approximately +5 V (reference voltage: About 0 V)
Output resistance	1 k Ω $\pm 20\%$ at 0 V 3.3 k Ω $\pm 20\%$ at +5 V

1-2-11 Battery Back Up

Back up item	ALL SET UP and 4 Waveform Memories
Back up time	10 days (-20°C to +70°C)

1-2-12 Power Supply

Voltage range	90 V to 250 V
Bandwidth	50 to 440 Hz
Power consumption	DS-6121 Approximately 120 W (at 100 V)
	DS-6121A Approximately 130 W (at 100 V)

1-3 DIMENSIONS AND WEIGHT

Weight	Approximately 13 kg
Dimensions	320±2 (W) × 160±2 (H) × 465±2 (L) [mm]

Figure 1-3. Dimensions

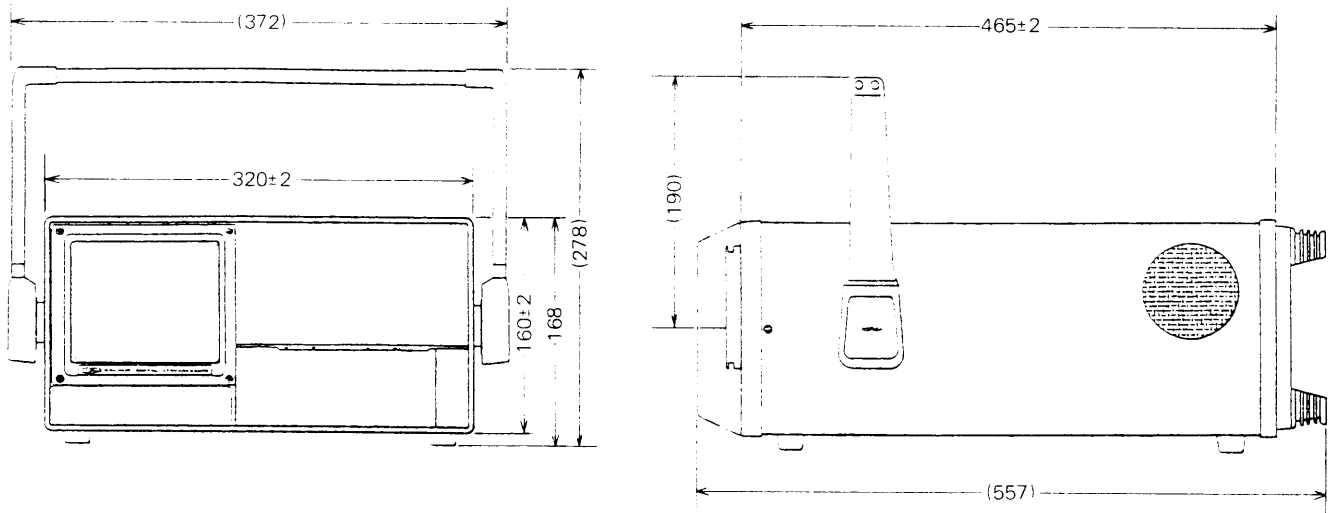

1-4 ENVIRONMENTAL CHARACTERISTICS

Operating temperature	0°C to 40°C
Operating humidity	40°C, 90% relative humidity
Storage temperature	-20°C to +70°C
Storage humidity	70°C, 80% relative humidity
Altitude	Operating: 5,000 m maximum (atmospheric pressure 405 mmHg) Non-operating: 15,000 m maximum (atmospheric pressure 90 mmHg)
Vibration	From 10 Hz to 55 Hz and back in 1 minute; double amplitude 0.63mm; for 15 minutes each in vertical, horizontal, and longitudinal directions for a total of 45 minutes.
Impact	One side is raised to an elevation angle of 30° (10 cm maximum), and let fall on a piece of hard wood. Each side is put to this test 3 times.
Drop	A package ready for transportation is dropped from a height of 60 cm.

1-5 ACCESSORIES

Power cord	1
Fuse FSA-3	2
Probe (SS-0012R)	2
Accessories bag	1
Panel cover	1
Dust cover	1
Manual sheet	1
Instruction manual	1

Section 2 Controls, Connectors and Indicators

The following descriptions are intended to familiarize the operator with the location and function of the instrument's controls, connectors and indicators.

2-1 FRONT PANEL

Figure 2-1. Front Panel

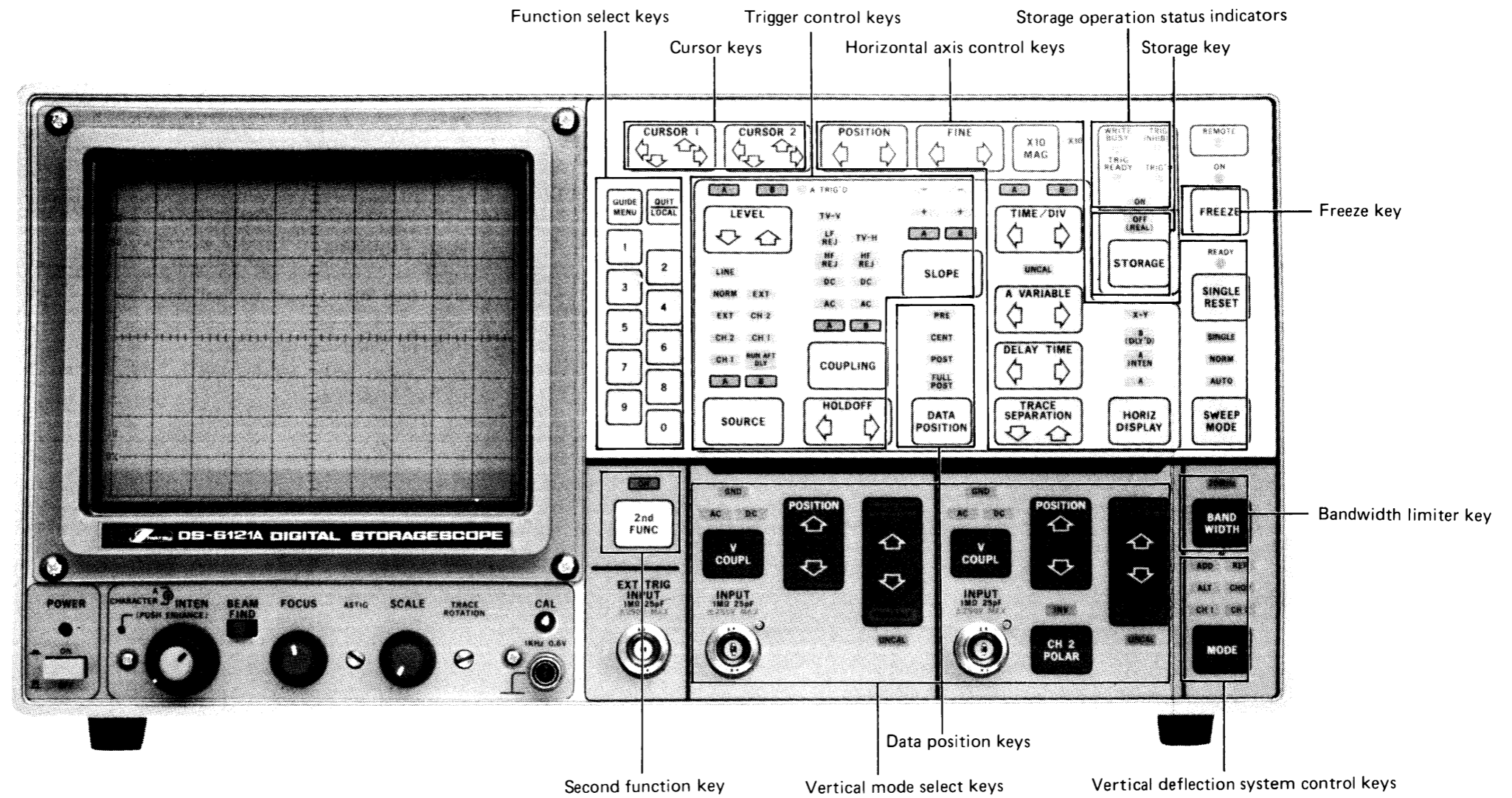

2-1-1 Power and Display

- ① **POWER**
A push-push switch used to turn the instrument power on and off. It must be pushed in to apply power to the instrument and pushed in again to release the switch and remove power from the instrument.
- ② **Power On Indicator**
Illuminates when POWER switch is set to the "on" position and power is applied to the instrument.
- ③ **INTENSITY (Slate Grey)**
Adjusts brightness of the CRT trace display. This control does not affect intensity of the CRT readout display.
- ④ **CHARACTER INTENSITY (Slate Grey) and PUSH ENHANCE (Warm-grey)**
CHARACTER INTENSITY:
Adjusts the intensity of the CRT readout (character) display.
PUSH ENHANCE:
Enhances brightness of the CRT trace display when this knob is set to "on" position.
- ⑤ **PUSH ENHANCE Indicator**
Illuminates when PUSH ENHANCE knob is set to "on" position.
- ⑥ **BEAM FIND**
When held in, the display is compressed to within the graticule area and a visible viewing intensity is provided to aid in locating off-screen displays.
- ⑦ **FOCUS**
Adjusts for optimum display definition.
- ⑧ **ASTIG**
Screwdriver control used in conjunction with the FOCUS control to obtain a well-defined display. It does not require readjustment during normal use of the instrument.
- ⑨ **SCALE**
Adjusts graticule illumination.
- ⑩ **TRACE ROTATION**
Screwdriver control used to align a baseline trace with the horizontal graticule lines.
- ⑪ **CALIBRATOR Output**
0.6 V square-wave voltage output (at approximately 1 kHz) that permits the operator to compensate voltage and to check oscilloscope vertical operation.
- ⑫ **⊥ (Ground terminal)**
Signal ground terminal for measurement. Connect it to the ground terminal of the circuit to be measured.

Figure 2-1-1. Power, Supply and Calibrator

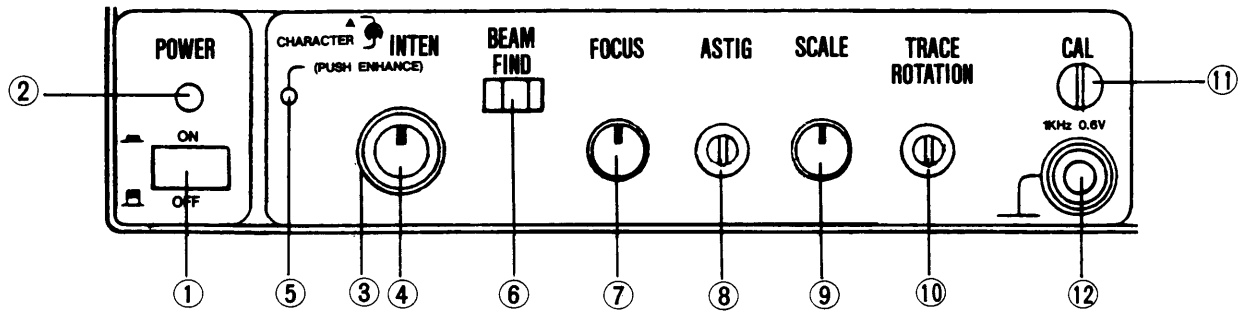

2-1-2 Vertical Deflection System

⑬ VOLTS/DIV

Selects the vertical deflection factor from 1 mV/DIV to 5 V/DIV in 12 steps for CH 1 and CH 2 in a 1-2-5 sequence.

⑭ VARIABLE

Provides variable uncalibrated deflection factors between the calibrated settings of the VOLTS/DIV when 2nd
FUNC is set to ON.

⑮ UNCAL Indicator

Illuminates when the VARIABLE is out of the calibrated position. It indicates that the vertical deflection factor is uncalibrated.

⑯ POSITION

Controls the vertical position of the channel displays. In the X-Y mode, the CH 2 POSITION control adjusts the vertical positioning of the display.

⑰ V COUPL

Selects the method of coupling the input signal to the vertical deflection system.

AC: Signals are capacitively coupled to the vertical deflection system. The DC component of the input signal is blocked.

DC: All frequency components of the input signal are passed to the vertical input amplifier.

GND: The input of the vertical amplifier is grounded to provide a ground reference and to allow the input coupling capacitor to be precharged to the input signal DC level through a high resistance connected to ground.

⑱ CH 1 (or X) and CH 2 (or Y) Connectors

Provide for application of external signals to the inputs of the vertical deflection system or for an X-Y display. In the X-Y mode, the signal connected to the CH 1 (or X) connector provides horizontal deflection, and the signal connected to the CH 2 (or Y) connector provides vertical deflection.

⑲ Vertical MODE

Selects the vertical mode of operation.

• **WHEN STORAGE OFF (REAL): SELECT CH 1, CH 2, ALT, CHOP, ADD**

• **WHEN STORAGE ON: SELECT CH 1, CH 2, CH 1 & CH 2, CH 1 CH 2 & REF**

CH 1: Selects CH 1 input signal for display.

CH 2: Selects CH 2 input signal for display.

ALT: When ALT is selected, the Vertical Switching circuitry is alternately switched between two of the selected vertical modes at the end of each sweep.

CHOP: When CHOP is selected, the Vertical Switching circuitry is switched between two of the selected vertical modes at approximately a 500-kHz rate.

ADD: Selects the algebraic sum of CH 1 and CH 2 input signals to be displayed.

CH 1 & CH 2: Displays two digitized signals simultaneously that are applied to CH 1 and CH 2.

CH 1 CH 2 & REF: Signals to be applied to the CH 1 and CH 2 can be saved in memory 1) to 4) and display two of them in the REF 1 and the REF 2. Transfers the CH 1 and CH 2 to the REF 1 and REF 2 by MOVE function.

⑳ 20 MHz BANDWIDTH

Limits the bandwidth of the vertical amplifier to approximately 20 MHz. A LED illuminates to indicate that the bandwidth is limited to 20 MHz.

㉑ CH 2 POLAR

Inverts CH 2 display. A LED illuminates to indicate that the polarity is inverted.

Figure 2-1-2. Vertical Deflection System

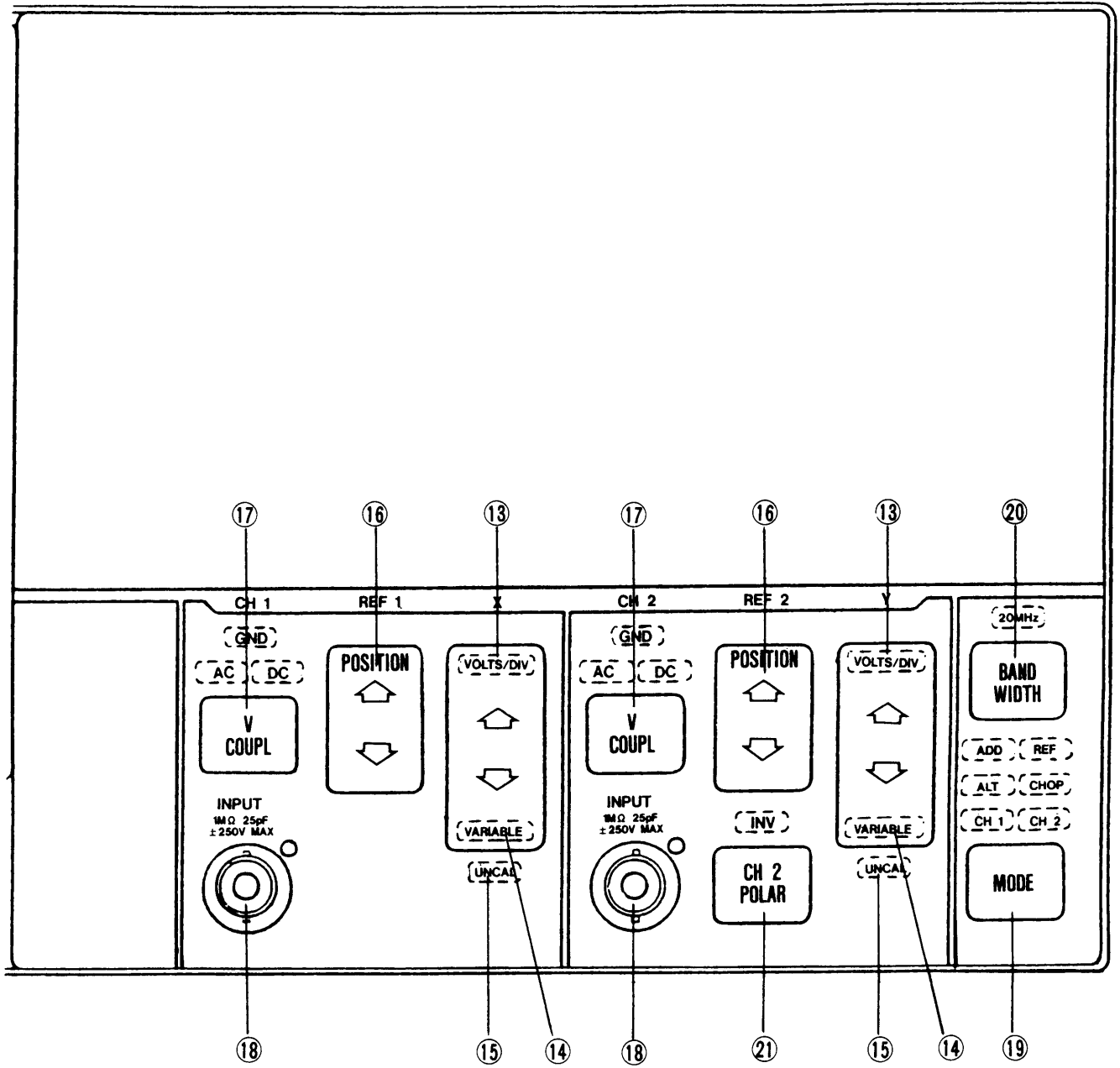

2-1-3 TRIGGERING

②② SOURCE

Selects the source of the trigger signal coupled to the input of the trigger circuit.

CH 1: The signal applied to the CH 1 input connector is the source of the trigger signal. CH 2 signal display is unstable if it is not time related to the CH 1 signal.

CH 2: The signal applied to the CH 2 input connector is the source of the trigger signal. The CH 1 signal display is unstable if it is not time related to the CH 2 signal.

EXT: The signal connected to the External Trigger Input connector is used for triggering. External signals must be time related to the displayed signal for stable display. This position is useful when the internal signal is either too small or contains undesired components that cause unstable triggering.

NORM (in the A Sweep Trigger circuit only):

The waveform displayed on the CRT is the source of a composite trigger signal. Stable triggering of non-time-related signals usually can be obtained by setting VERT MODE to ALT, SOURCE to NORM, COUPLING to LF REJ (high-frequency signals only), and adjusting the Trigger LEVEL control for a stable display. Time relationship between the CH 1 signal and the CH 2 signal is not indicated by the display.

LINE (in the A Sweep Trigger circuit only):

The ac-power source waveform is the source of the trigger signal. This position is useful when the input signal is time related (multiple or submultiple) to the frequency of the ac-power source or when it is desirable to provide a stable display of a power-source frequency component in a complex waveform.

RUN AFTER DELAY (in the B Sweep Trigger circuit only): B Sweep starts immediately after the delay time selected by the DELAY TIME POSITION control. In this position, the B Sweep is independent of the B trigger signal.

②③ EXT TRIG INPUT

Provides for application of external triggering signals to the A TRIGGER and B (DLY'D) TRIGGER circuits, when either EXT SOURCE is selected.

②④ COUPLING

Determines method used to couple a signal to the input of the trigger generator circuit.

AC: Signals are capacitively coupled to the input of the trigger circuit. The dc component is rejected, and signals below approximately 100 Hz are attenuated. Triggering is allowed only on the ac portion of the vertical signal.

DC: All frequency components of a trigger signal are coupled to the input of the trigger circuit. This position is useful for providing a stable display of low-frequency or low-repetition-rate signals.

HF REJ: Signals are capacitively coupled to the input of the trigger circuit. The dc component is rejected, and signals below approximately 10 Hz and above approximately 500 kHz are attenuated. This position is useful for providing a stable display of the low-frequency components of a complex waveform.

LF REJ: Signals are capacitively coupled to the input of the trigger circuits. The dc component is rejected, and signals below approximately 10 kHz are attenuated. This position is useful for providing a stable display of the high-frequency components of a complex waveform.

TV-V (in the A Sweep Trigger circuit only): This trigger coupling is used for observing a composite video signal waveform over a period of 1 V by triggering with a television vertical trigger pulse.

TV-H (in the B Sweep Trigger circuit only): This trigger coupling is used for observing a composite video signal waveform over a period of 1 H by triggering with a television horizontal trigger pulse.

- ②5 SLOPE
 Selects the slope of the signal that triggers the sweep.
 + (plus): Sweep can be triggered from the positive-going portion of a trigger signal.
 - (minus): Sweep can be triggered from the negative-going portion of a trigger signal.
- ②6 A TRIG'D Indicator
 Illuminates to indicate the A Sweep is triggered.
- ②7 LEVEL
 Selects the amplitude point on the trigger signal at which the sweep is triggered. This control is usually adjusted for the desired display after the Trigger SOURCE, COUPLING, and SLOPE have been selected.
- ②8 HOLDOFF
 Provides continuous control of holdoff time between sweeps. Allows triggering on a periodic signals (such as complex digital words).

Figure 2-1-3. TRIGGERING

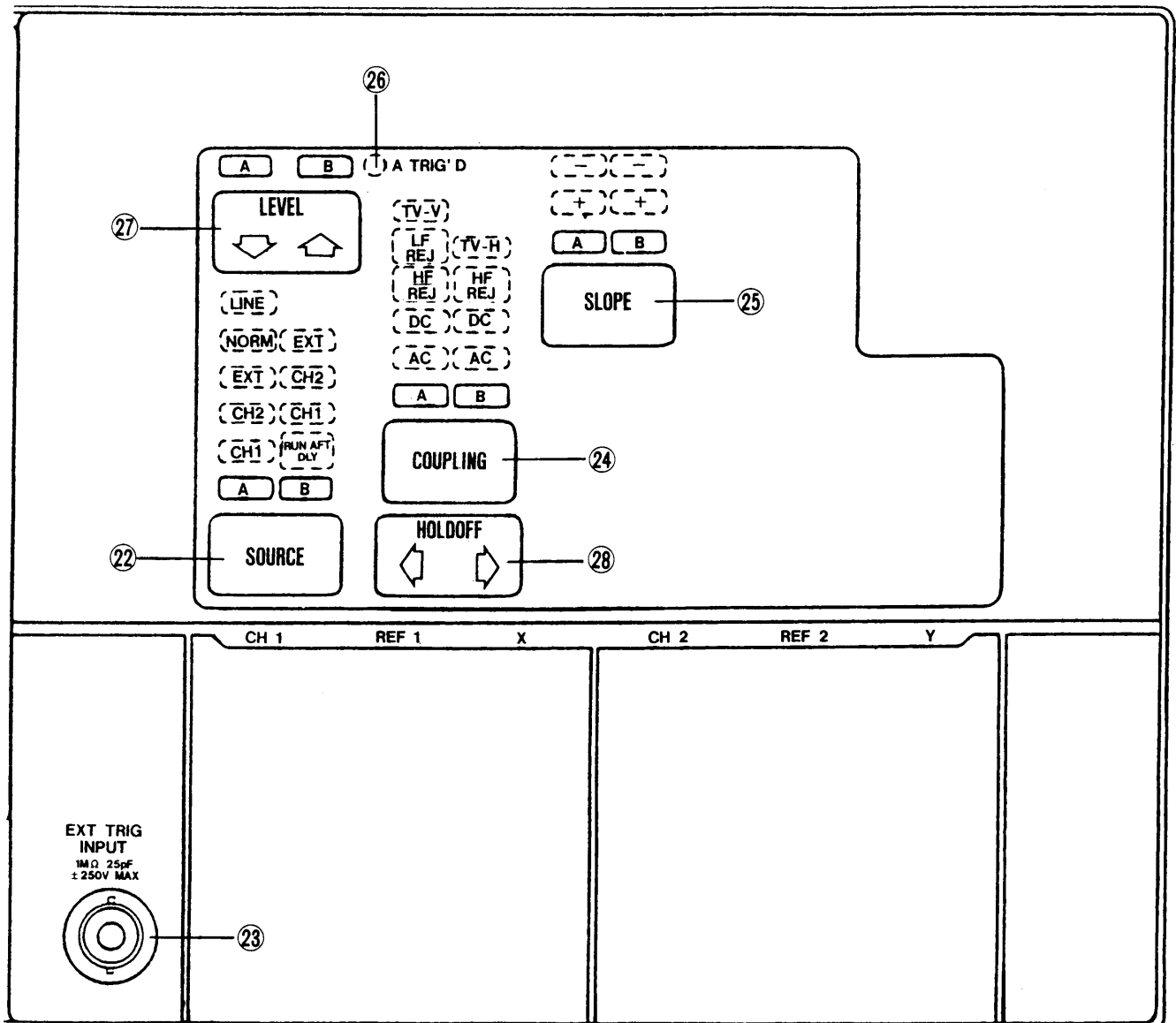

2-1-4 Horizontal System

②9 SWEEP MODE

Determines the mode of trigger operation for the instrument.

AUTO: Permits triggering on waveforms with a repetition rate of about 20 Hz or greater. Sweep free runs and provides a bright base-line when either an adequate trigger signal is absent, or if the repetition rate of the trigger signal is below 20 Hz.

NORM: Sweep is initiated when an adequate trigger signal is applied.

SINGLE: Sweep is initiated one time when an adequate trigger is applied. Sweep cannot be initiated again until the sweep logic

is reset by pressing the



③0 SINGLE RESET

Sweep is initiated one time by pressing this key in the SINGLE mode.

③1 READY Indicator

Illuminates in the SINGLE mode to indicate that the sweep circuitry is armed and ready to initiate the sweep when a trigger signal occurs.

③2 HORIZ DISPLAY

Select the mode of operation for the horizontal deflection system.

A: Displays only the A Sweep. The horizontal deflection rate are determined by the setting of the A TIME/DIV switch.

A INTEN: Displays the A Sweep at a rate determined by the setting of the A TIME/DIV switch. An intensified portion corresponding to the length and position of the B Sweep will appear on the trace when the B Sweep is properly triggered. The INTENSITY control should be adjusted to obtain the proper brightness for viewing.

A INTEN and B DLY'D (ALT): Alternates the display between the A INTEN and B DLY'D sweeps. The TRACE SEPARATION control will position the B display vertically.

B DLY'D: Displays only the B Sweep. The B Sweep rate is determined by the setting of the B TIME/DIV switch, and the delay time is determined by DEALY TIME control.

③3 A and B TIME/DIV

A TIME/DIV: Selects 27 calibrated sweep rates from 10 s to 20 ns/DIV in a 1-2-5 sequence.

B TIME/DIV: Selects 21 calibrated sweep rates from 0.1 s to 20 ns/DIV in a 1-2-5 sequence.

③4 A VARIABLE

Provides continuously variable uncalibrated A Sweep rates to at least 2.5 times the calibrated setting. This control is effective only in the STORAGE OFF (REAL).

③5 UNCAL Indicator

Illuminates to indicate that the A time base sweep rate is uncalibrated (VARIABLE control is out of calibrated position). In the STORAGE modes the VARIABLE control is ignored, and the UNCAL LED is not illuminated.

③6 X10 MAG

Increases the displayed sweep rate by factor of 10. Extends the fastest sweep rate to 20 ns/DIV. The magnified sweep expands the center division of the unmagnified display. Indicator LED illuminates to indicate that the horizontal display is magnified.

③7 POSITION

Positions the displays horizontally. Provides both coarse and fine control action.

③8 DELAY TIME

Selects the amount of delay time between the start of the A Sweep and start of the B Sweep. Delay time is variable to at least 10 times the A TIME/DIV switch setting. This control is used in conjunction with the RUN AFT D'LY position of the B SOURCE switch.

③9 TRACE SEPARATION

Positions the B Sweep vertically when the ALT horizontal display mode is selected.

④ DATA POSITION

Selects the amount of pre-trigger data displayed when in STORAGE ON.

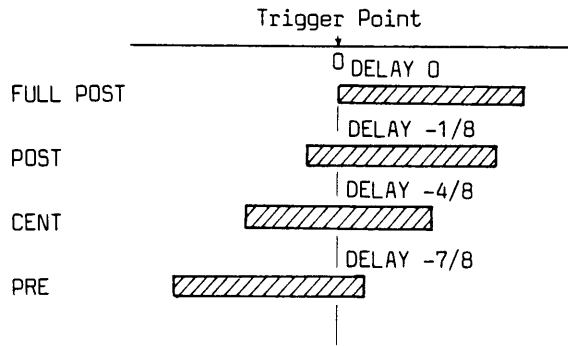
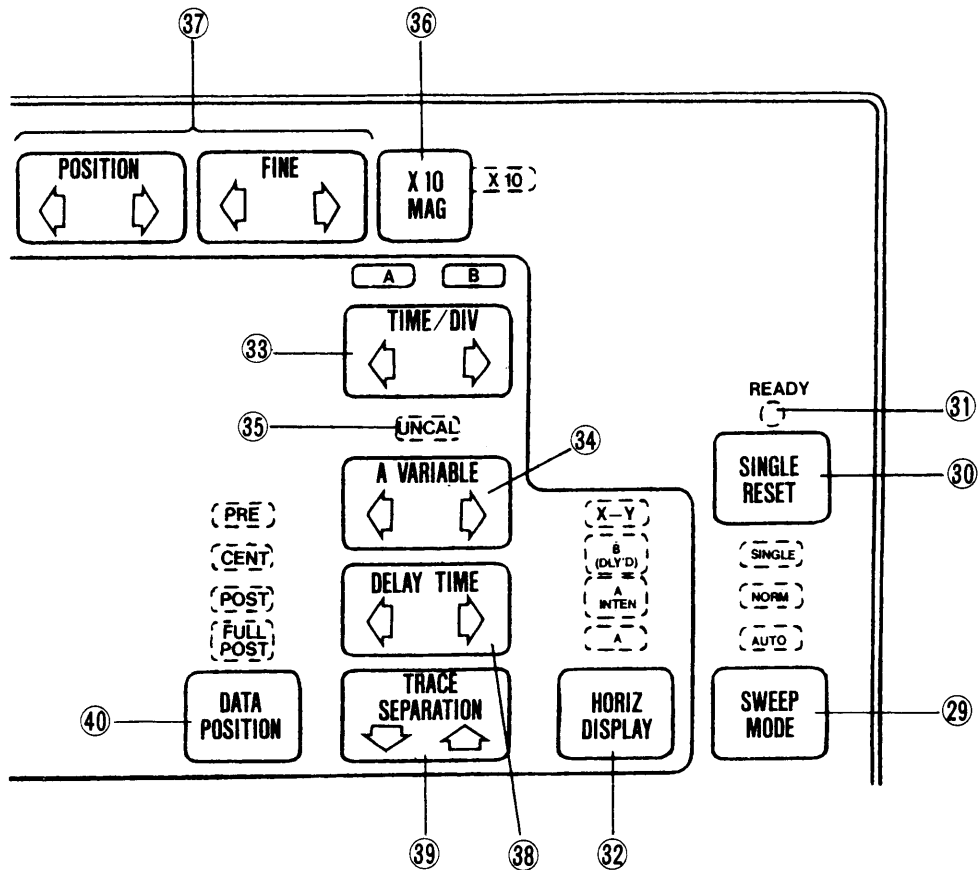

Figure 2-1-4. Horizontal System



2-1-5 STORAGE, GUIDE MENU and Others**④1 STORAGE**

Selects STORAGE ON (storage-scope) or OFF (oscilloscope).

④2 FREEZE

Selects whether freeze storage waveform or not in storage ON mode.

④3 REMOTE

Illuminates when REN (REMOTE ENABLE) line of GP-IB is controlled in TRUE state.

④4 WRITE STATUS Indicator

WRITE BUSY: Illuminates during WRITE operation, and goes off when WRITE operation is completed.

TRIG READY: Illuminates in a state ready to receive a trigger signal. Goes off, therefore, after the trigger signal was received.

TRIG INHIBIT: Illuminates in a state not ready to receive a trigger signal. TRIG READY state is reached after a set WORD number of CLOCKS are passed while POST, CENT, or PRE was selected for DATA POSITION. The trigger signal is not received if TRIG READY state is not reached.

TRIG'D: Illuminates when a trigger pulse is generated. Check that this is illuminating when writing in an observed signal.

④5 2nd FUNC

Key mainly selecting for B SWEEP, B TRIGGER or VOLTS/DIV VARIABLE.

④6 GUIDE MENU

Displays guide menu.

④7 Numeral Keys

Numeral keys (1 to 0) to select the function.

④8 CURSOR

Two keys control position of CRT Cursors. Cursors are used to select measurement points on the displayed waveform.

④9 QUIT/LOCAL

Has both functions of QUIT and LOCAL.

QUIT: Clears FUNCTIONS selected on GUIDE MENU.

LOCAL: Returns the DS-6121 to LOCAL state (a state in which panel operations are effective) from REMOTE state.

Figure 2-1-5. STORAGE, GUIDE MENU and Others

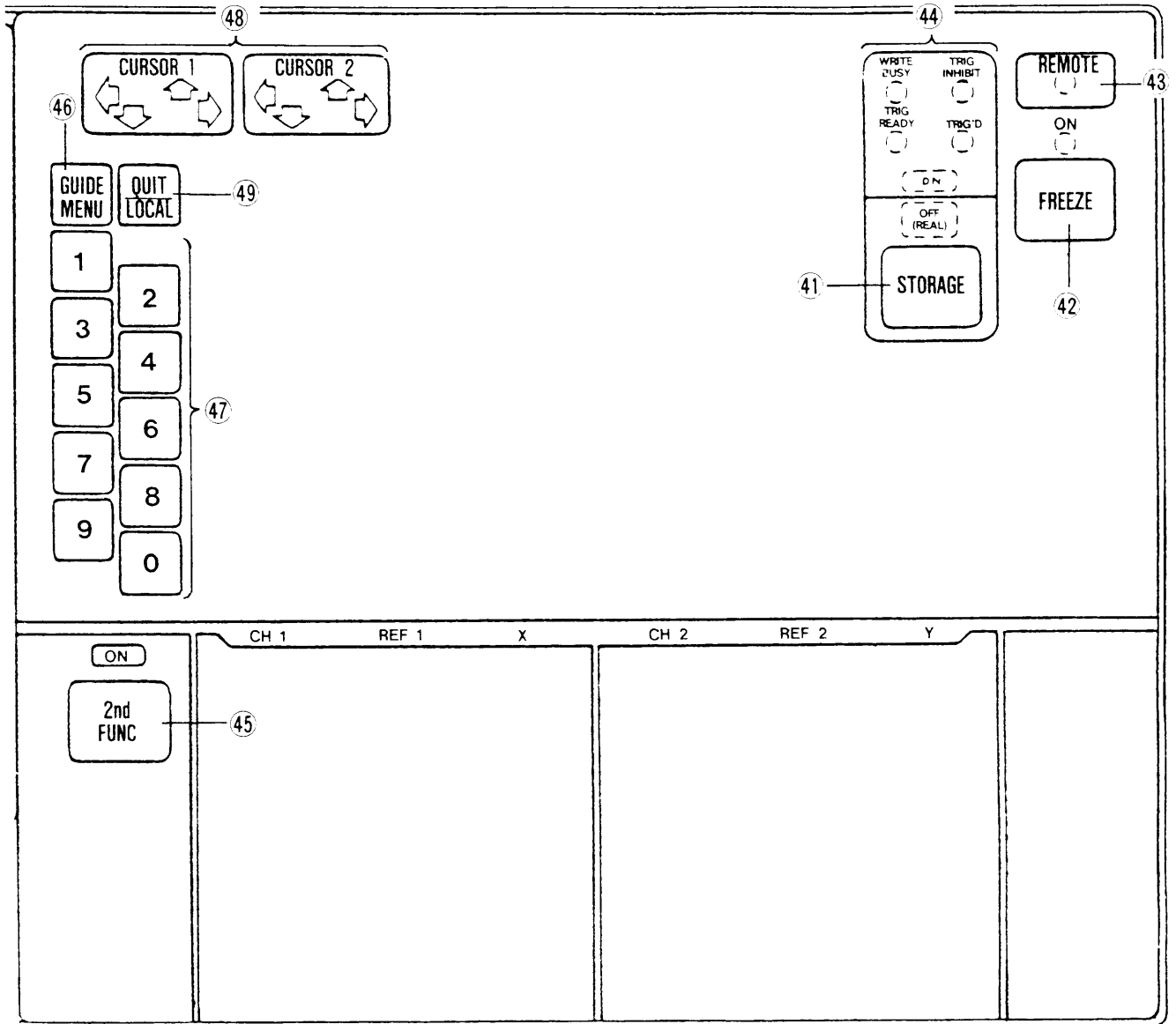

2-2 REAR PANEL

⑤0 REAL SIGNALS — STORAGE SIGNALS

Outputs REAL or STORAGE SIGNALS.

Refer to ⑤1 to ⑤4 for REAL SIGNALS and ⑤5 to ⑤8 for STORAGE.

REAL SIGNALS

⑤1 CH 1 OUTPUT

Bnc connector providing an output signal with an amplitude of approximately 30 mV per each division of displayed CH 1 signal.

⑤2 A GATE OUTPUT

Bnc connector providing an approximately 5 V, positive-going square wave coincident with the A Sweep time.

⑤3 B GATE OUTPUT

Bnc connector providing an approximately 5 V, positive-going square wave coincident with the B Sweep time.

⑤4 Z-AXIS INPUT

Bnc connector used to apply external signals to the Z-axis amplifier to intensity modulate the display. Intensity modulation does not affect the displayed waveshape. Signals with fast rise and fall time provide the most abrupt intensity change. Positive-going signals decrease the intensity, and a 5 V_{p-p} signal will produce noticeable modulation.

STORAGE SIGNALS

⑤5 GO/NO GO OUT

Outputs GO/NO GO signal. Output voltage is approximately 5 V on the side of GO, and approximately 0 V on the side of NO GO. Output resistance is 3.3 k Ω ±20% on the side of GO, and 1 k Ω ±20% on the side of NO GO.

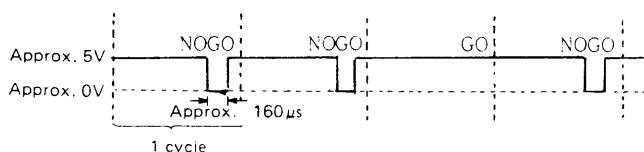

⑤6 PEN Y OUTPUT

Outputs analogue signal for Y-axis of pen recorder. Output voltage is approximately 0.2 V per division. Output resistance is 1 k Ω ±20%.

⑤7 PEN X OUTPUT

Outputs analogue signal for X-axis of pen recorder. Output voltage is approximately 0.2 V per division. Output resistance is 1 k Ω ±20%.

⑤8 PEN UP OUTPUT

Outputs the pen-up signal for pen recorder. Output voltage is approximately 5 V on UP side, and 0 V on DOWN side. Output resistance is 2.9 k Ω ±20% on UP side and 600 Ω ±30% on DOWN side.

⑤9 EXT CLOCK INPUT

Inputs the external clock signal. Clock signal which is less than 0.6 V at low level, and over 2.7 V at high level. Input voltage is \pm 50 V MAX.

OTHERS

⑥0 CAL 10 mA

Current at 1 kHz, 10 mA flows in the direction of arrow mark (from right to left) at the current loop terminal. Current output is used for check and correction of current probe.

⑥1 (Grounding terminal for protection)

It is used for protection. When power socket is not made of three-wire system, be sure to make grounding of this terminal for preventing the danger.

⑥2 FUSE

This is a fuse holder. After change of line, voltage be certain correct, slow-blow fuse of 3 A/250 V is used.

⑥3 AC LINE INPUT

Connected a power-supply cord.

- ⑥④ Hole for Options
 Inserts the GP-IB pack or the RS-232-C pack.

Figure 2-2. Rear Panel

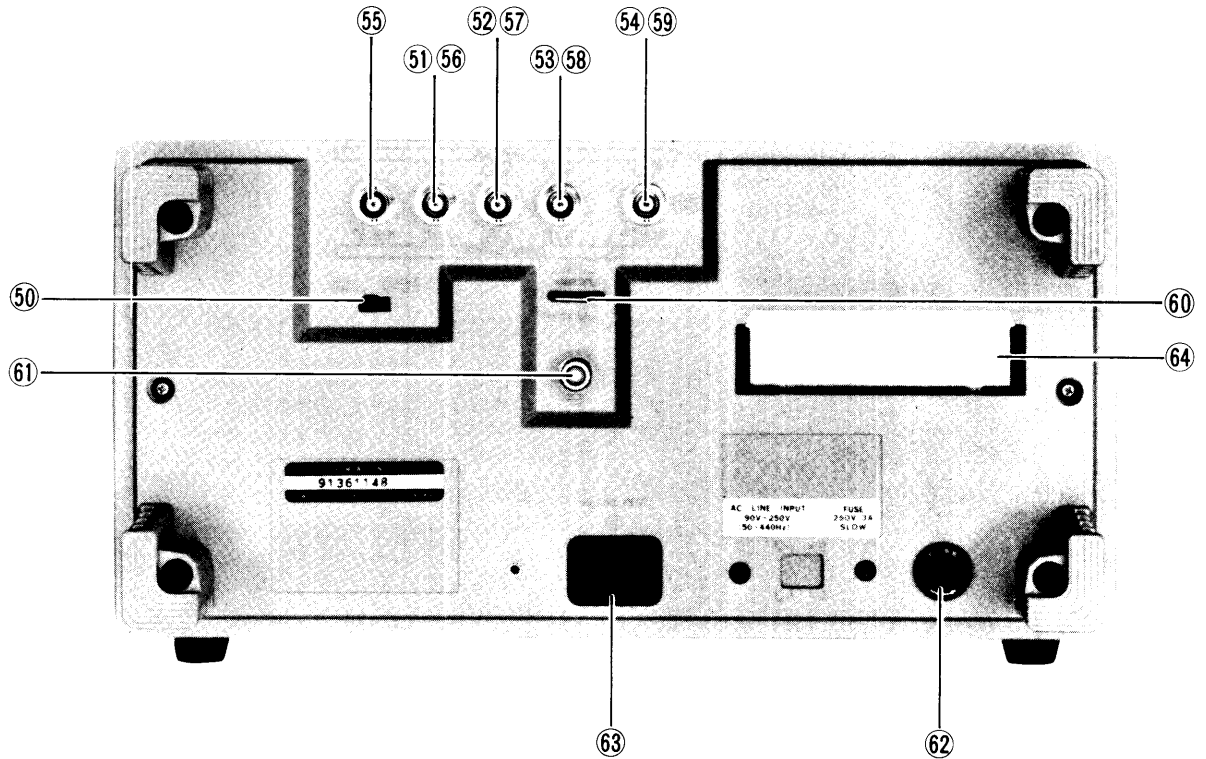

2-3 BOTTOM**⑥⑥ CH 1 GAIN**

Adjusts CH 1 vertical deflection factor.

⑥⑦ CH 2 GAIN

Adjusts CH 2 vertical deflection factor.

⑥⑧ CH1 5 mV BAL

Adjusts for minimizing the vertical movement of the trace with CH 1 VOLTS/DIV control set to 10 mV/5 mV position.

⑥⑨ CH2 5 mV BAL

Adjusts for minimizing the vertical movement of the trace with CH 2 VOLTS/DIV control set to 10 mV/5 mV position.

Figure 2-3. Bottom

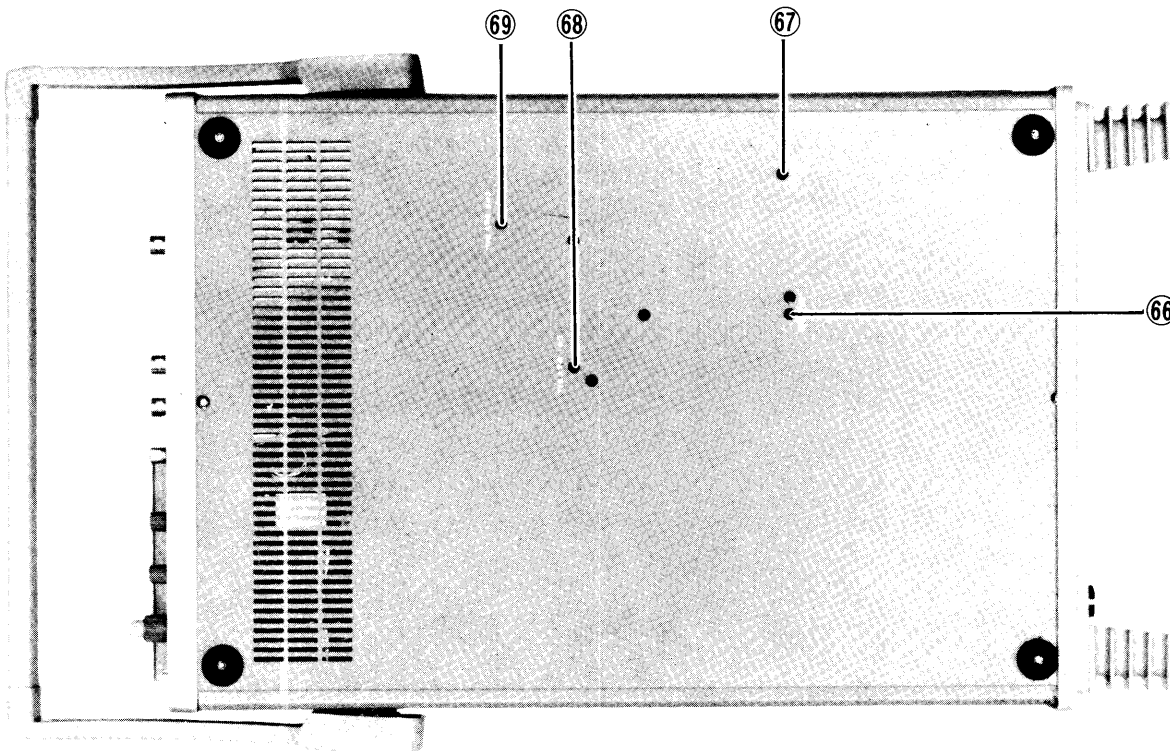

2-4 READOUT

2-4-1 Display of Setting Control Values from Panel

Control setting values selected on the front panel are displayed in the following positions on the CRT screen.

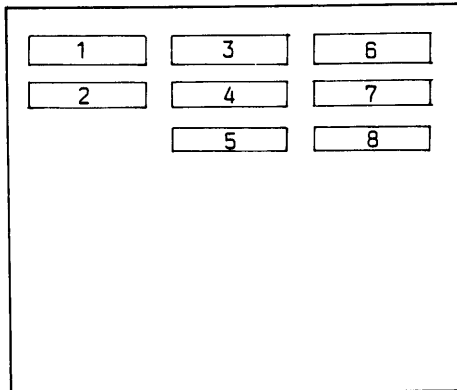

1. CH 1 VOLTS/DIV

Displays the voltage per division.

- When CH 2 is selected, the value is displayed with "()".
- When UNCAL is selected, the value is displayed with ">".

2. CH 2 VOLTS/DIV

Same as in CH 1.

3. A TRIGGER LEVEL

A TRIGGER LEVEL is displayed in the range between +100% (upper limit) and -100% (lower limit).

- When B SWEEP is selected, the value is displayed with "()".

4. HOLDOFF

HOLDOFF TIME is displayed in the range between 100% (upper limit) and 0% (lower limit).

- Nothing is displayed when the HOLDOFF TIME is 0%.

5. B TRIGGER LEVEL

B TRIGGER LEVEL is displayed in the range between +100% (upper limit) and -100% (lower limit).

6. A TIME/DIV

Sweep time per DIV is displayed.

- When UNCAL is selected, the value is displayed with ">".

7. DELAY TIME

DELAY TIME MULTI is displayed in the range between 0.200 and 10.238.

8. B TIME/DIV

Sweep time per DIV is displayed.

2-4-2 Display of REF

Displays when setting REF (selectable only in STORAGE mode).

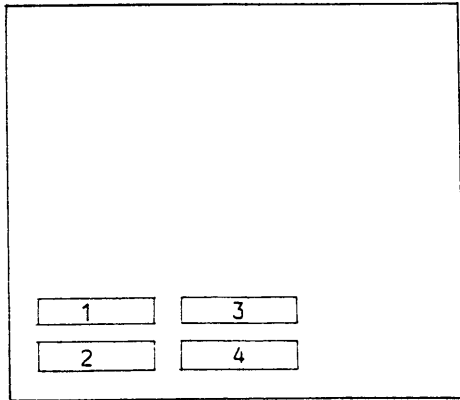

1. REF 1 Deflection Factor
Displays the voltage per DIV when the waveform is saved.
2. REF 2 Deflection Factor
Same as in REF 1 Deflection Factor.
3. REF 1 Sweep Time
Displays the sweep time per DIV in A SWEEP or B SWEEP when the waveform is saved.
4. REF 2 Sweep Time
Same as in REF 1 Sweep time.

2-4-3 Cursor Measurement Value Display

Displays when the measurement by cursors is selected.

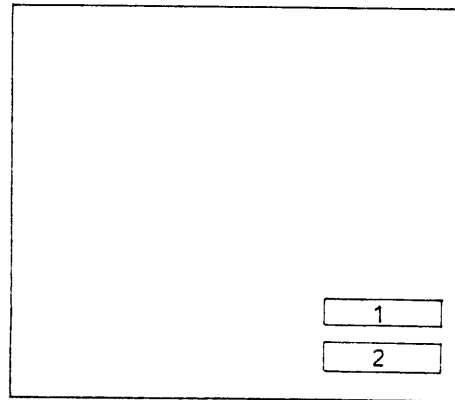

Measured Items \ Displayed Position	1	2
Δ Voltage	CH 1 (V)	CH 2 (V)
Voltage Ratio	CH 1 (dB, %)	CH 2 (dB, %)
Δ Time	Time(s)	Frequency (Hz)
Phase	—	Phase (degree)
Δ V on WAVEFORM	CH 1 (V)	CH 2 (V)

When UNCAL is selected for Y-AXIS Deflection Factor or SWEEP TIME, the value is displayed with " > ".

2-4-4 Guide Menu Display

When  key is pressed, the Guide Menu is displayed.

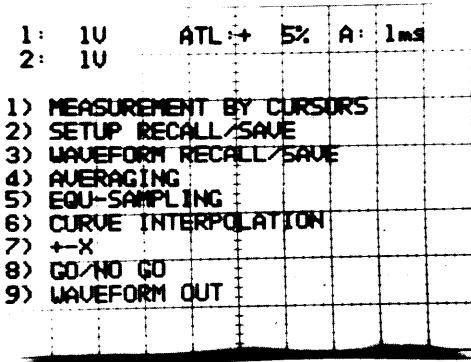

DS-6121

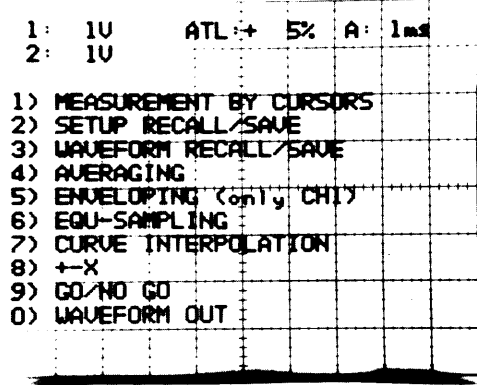

DS-6121A

FUNCTION selected in the Guide Menu is displayed as in the following.

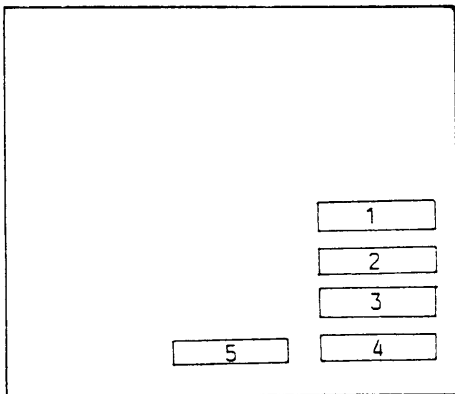

1. GO/NO GO
Displays IN or OUT RANGE together with evaluated results.
2. + - X
Displays the type of calibration.
3. AVERAGING
4. EQU-SAMPLING or ENVELOPING (DS-6121A)
5. CURVE INTERPOLATION

2-5 OPERATION OF THE HANDLE AND REMOVAL OF THE ACCESSORIES BAG

2-5-1 Operation of the Handle

The carrying-handle of the DS-6121/DS-6121A can be unlocked if the rotary part (root) of the handle is pressed inwards (in the arrow direction) as shown in Figure 2-5-1 (a).

If both the right and left ends are pushed, they can be unlocked together, and the handle can be turned as it is.

If the rotary part is released, the handle is automatically locked.

The handle can be positioned as desired for carrying (as shown in Figure 2-5-1 (a)) or as a stand for signal observation (as shown in Figure 2-5-1 (b)).

Fold the handle back as shown in Figure 2-5-1 (c), if possible, when storing the DS-6121/DS-6121A.

2-5-2 Removal of the Accessories Bag

When removing the accessories bag from the upper cover of the DS-6121/DS-6121A, remove the four screws as shown in Figure 2-5-2.

Use the same screws for mounting the accessories bag on the upper cover again.

Figure 2-5-1. How to Place the DS-6121/DS-6121A and Use the Handle

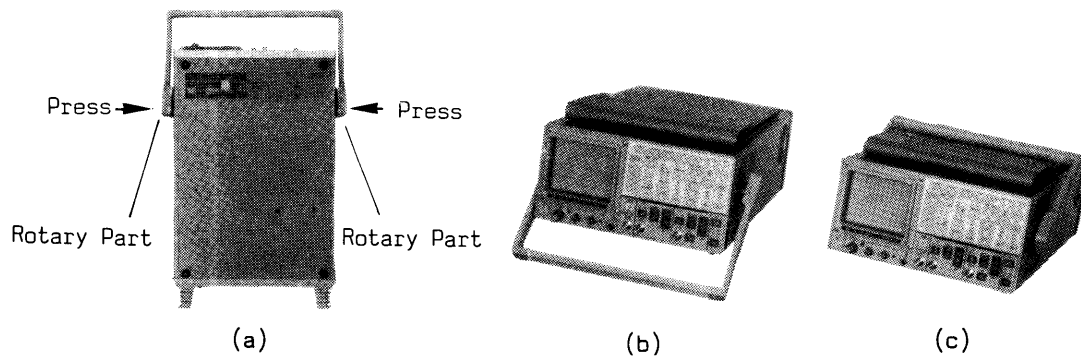
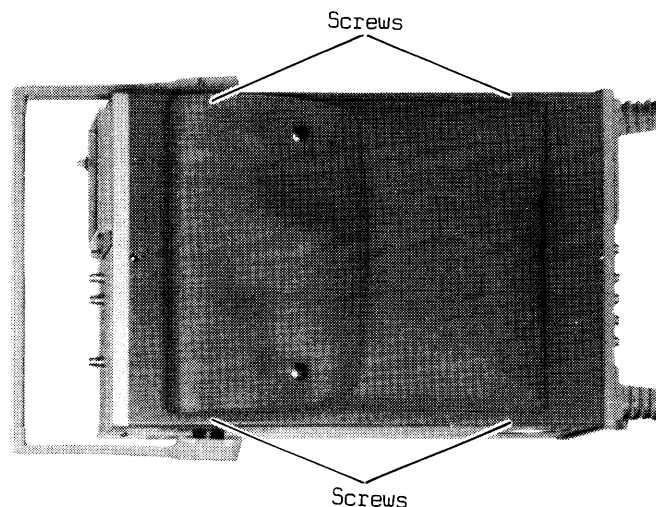

Figure 2-5-2. Removal of the Accessories Bag



Section 3 Operating Information

There are two ways for operation: one is operated by keys on the front panel and the other is controlled by GP-IB.

In this section described are the operating procedures under CAL (except 3-7-4 to 3-7-9) input using the attached probe SS-0012R. As to GP-IB see Section 4.

Figure 3. Connection of Probe

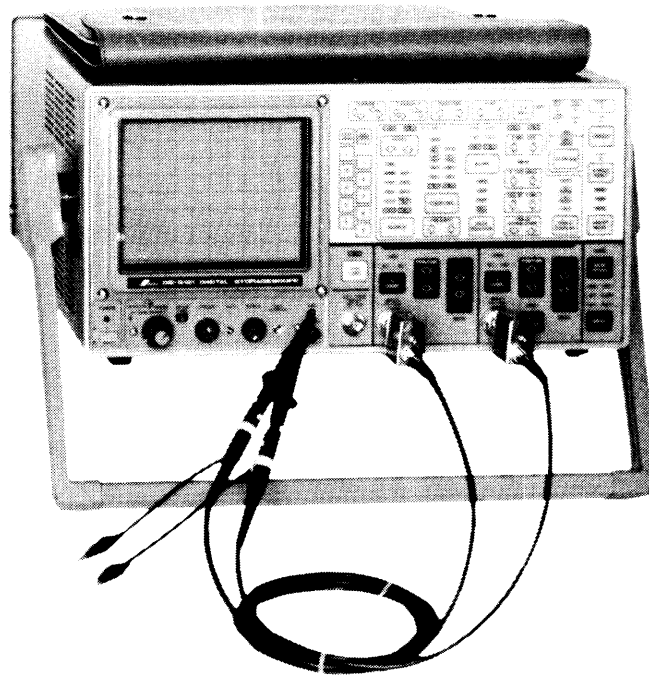

Operating Guide

This section is as follows

3-1 POWER 3 - 4

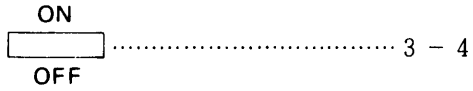

3-2 VERTICAL SYSTEM 3 - 6

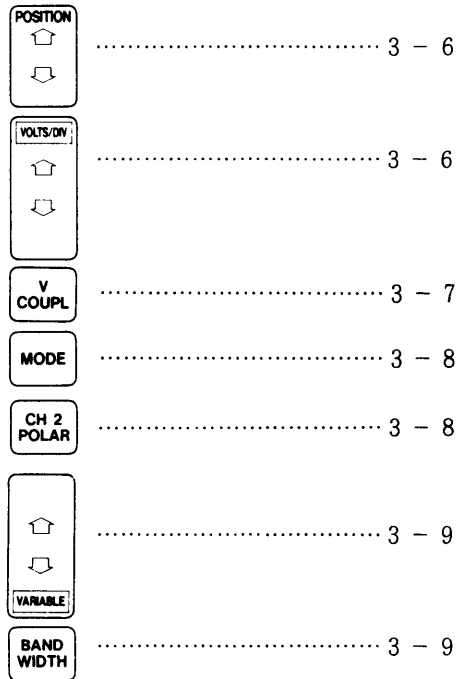

3-3 TRIGGERING 3 - 10

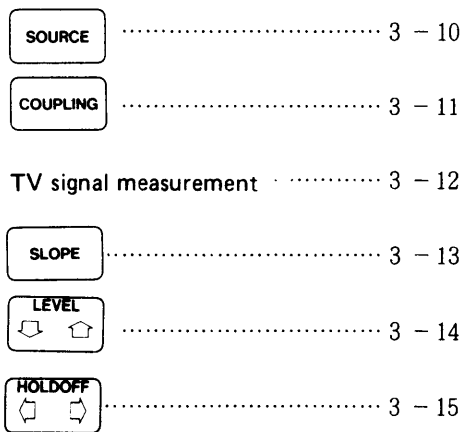

3-4 HORIZONTAL SYSTEM 3 - 16

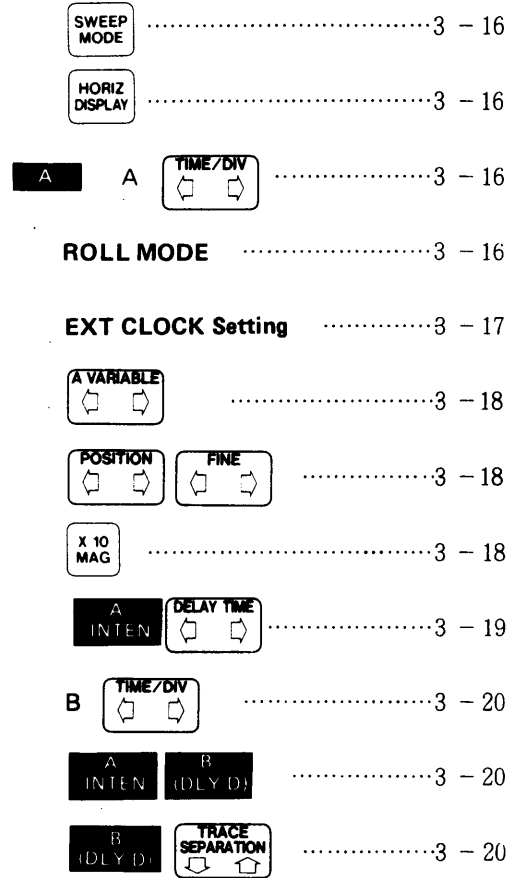

3-5 STORAGE 3 - 21

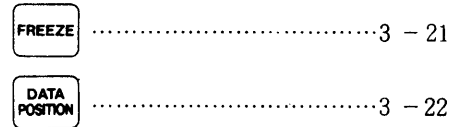

MAGNIFICATION 3 - 23

3-6 X-Y OPERATION 3 - 24

—DS-6121—

3-7 GUIDE MENU

 3 - 26

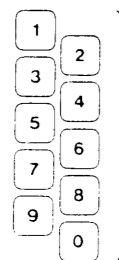
 3 - 26

Guide Menu Tree 3 - 27

Usage Range 3 - 28

Error Messages 3 - 28

Multiple-usage of Guide Menu 3 - 29

Quit of Guide Menu 3 - 29

 3 - 29

1) MEASUREMENT BY CURSORS

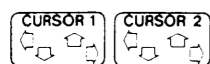
 3 - 30

Δ VOLTAGE 3 - 32

VOLTAGE RATIO 3 - 33

Δ TIME 3 - 34

PHASE 3 - 35

ΔV ON WAVEFORM 3 - 36

2) SETUP 3 - 37

SAVE 3 - 38

RECALL 3 - 40

3) WAVEFORM RECALL/SAVE 3 - 42

SAVE 3 - 42

RECALL 3 - 44

Observations of Four Phenomena 3 - 45

MOVE 3 - 46

Observation of Four Phenomena 3 - 47

4) AVERAGING 3 - 48

5) EQU-SAMPLING 3 - 50

6) CURVE INTERPOLATION 3 - 51

7) +-X 3 - 52

8) GO/NO GO 3 - 54

Definitions of IN-RANGE
and OUT-RANGE 3 - 54

CURSORS 3 - 56

WAVEFORMS 3 - 58

9) WAVEFORM OUT 3 - 60

X-Y Recorder 3 - 60

Plotter setting and others 3 - 62

Example for Construction 3 - 63

—DS-6121A—

3-7 GUIDE MENU

 3 - 66

 3 - 66

Guide Menu Tree 3 - 67

Usage Range 3 - 68

Error Messages 3 - 68

Multiple-usage of Guide Menu 3 - 69

Quit of Guide Menu 3 - 69

 3 - 69

1) MEASUREMENT BY CURSORS

 3 - 70

Δ VOLTAGE 3 - 72

VOLTAGE RATIO 3 - 73

Δ TIME 3 - 74

PHASE 3 - 75

ΔV ON WAVEFORM 3 - 76

2) SETUP 3 - 77

SAVE 3 - 78

RECALL 3 - 80

3) WAVEFORM RECALL/SAVE 3 - 82

SAVE 3 - 82

RECALL 3 - 84

Observations of Four Phenomena 3 - 85

MOVE 3 - 86

Observation of Four Phenomena 3 - 87

4) AVERAGING 3 - 88

5) ENVELOPING 3 - 90

6) EQU-SAMPLING 3 - 94

7) CURVE INTERPOLATION 3 - 95

8) +-X 3 - 96

9) GO/NO GO 3 - 98

Definitions of IN-RANGE
and OUT-RANGE 3 - 98

CURSORS 3 - 100

WAVEFORMS 3 - 102

0) WAVEFORM OUT 3 - 104

X-Y Recorder 3 - 104

Plotter setting and others 3 - 106

Example for Construction 3 - 107

3-1 POWER TURNING-ON AND CHECK OF INITIAL STATE

Power Turn-on

- ① Turn the power on, observe the "caution" item described right.

Check of Internal Operation

After the power is turned on, check whether the internal operation is normal.

- ② Adjust A INTENSITY and CHARACTER INTENSITY
- ③ Adjust FOCUS.
- ④ Check the waveforms on the CRT screen are as shown in Figure 3-1-1.

Figure 3-1-1. Check of Initial State

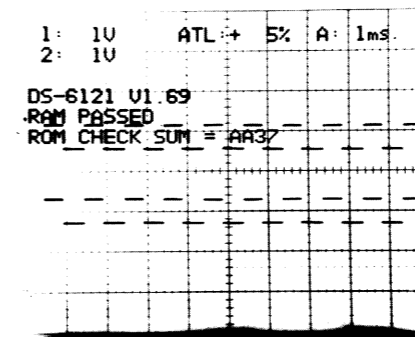

<Note> The numbers of version and ROM may change

RAM Check

Writes and reads the contents of the memory, and if they do not coincide. "FAULT" is displayed. When they do, "RAM PASSED" is displayed.

ROM Check

Performs CHECK-SUM and displays SUMMING DATA in hexadecimal of four digits.

A and Character Intensity

The knobs for individually changing the intensity of waveforms and of characters and cursors are located on the bottom of the CRT.

Photos taken in the REAL mode by single sweep may show waveforms with missing parts. In that case, the missing parts won't be shown by turning CHARACTER INTEN fully counterclockwise.

Caution

Line voltage check.

The DS-6121/DS-6121A can be used on 90V to 250V. Before plugging the power cord to an electrical output, be sure to check line voltage.

Use the supplied power cord.

Use the supplied 3-core power cord.

When operating the DS-6121/DS-6121A on the line voltage from a 2-core electrical outlet with the supplied 3-core power cord and a conversion adaptor, be sure to ground the protective ground terminal on the rear panel to prevent danger.

Initial State**Operation**

Write	Stop state
GP-IB	Local state
Recorder Output	Stop state
GO/NO GO Output	Stop state

Measurement Conditions

Vertical System

COUPL	AC (for both CH 1 and CH 2)
 POSITION	CH 1 1 DIV upper than midrange
	CH 2 1 DIV lower than midrange
VOLTS/DIV	0.1 V/DIV (for both CH 1 and CH 2)
VARIABLE	CAL (for both CH 1 and CH 2)
CH 2 POLAR	No INV
MODE	ALT
TRIGGERING	
A SOURCE	CH 1
A COUPLING	AC
A SLOPE	+
A LEVEL	+5%

Horizontal System

MODE	AUTO
HORIZ DISPLAY	A
A TIME/DIV	1 ms/DIV
A VARIABLE	CAL
STORAGE	OFF (REAL)

3-2 VERTICAL DEFLECTION SYSTEM

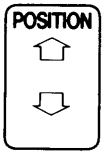

Setting

When the of CH 1 is pressed, the trace of CH 1 will go up; when the of CH 1 is pressed, it will go down. The same results for CH 2.

When the trace reaches the set ultimate position, "LMT" will blink at the upper left corner of the CRT.

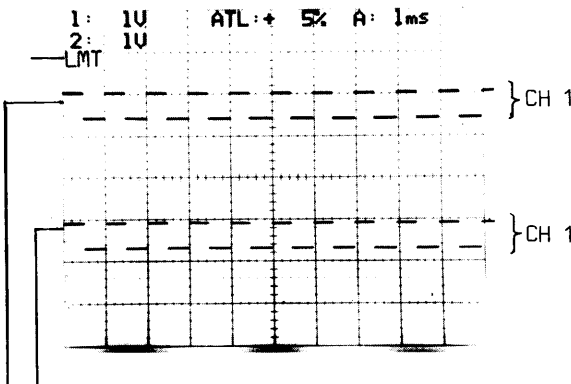

Goes down when of CH 2 is pressed.

Goes up when of CH 1 is pressed.

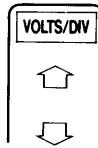

Setting

Setting is possible when **VOLTS/DIV** is illuminated. The deflection factor increases when is pressed, and reaches the final value 1 mV/DIV, decrease when is pressed and reaches the final value 5 V/DIV.

When the final set value is reached, "LMT" blinks on the upper left corner of the CRT.

Deflection factor of CH 1 is set at 0.2 V.

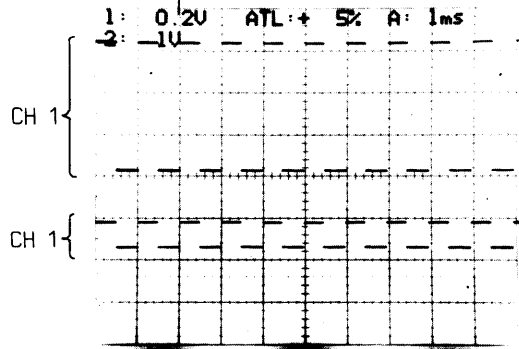

Probe sense

If the supplied SS-0012R probe is used, vertical deflection factor display is automatically switched to 10:1.

**V
COUPL** Setting

Every time **V
COUPL** is pressed, the setting will be switched as shown in the following.

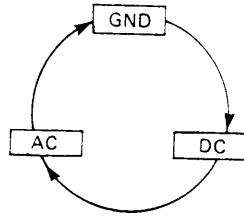

Shown below is the waveform at each **V
COUPL** setting of CH 1.

1) With **GND** to set the ground level.

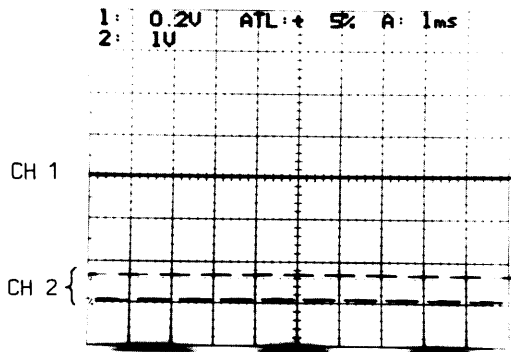

3) Observe with **AC**.

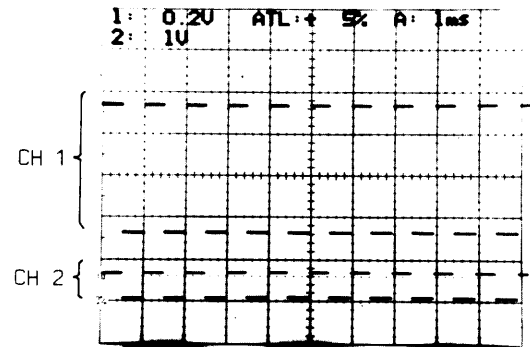

2) Observe with **DC**.

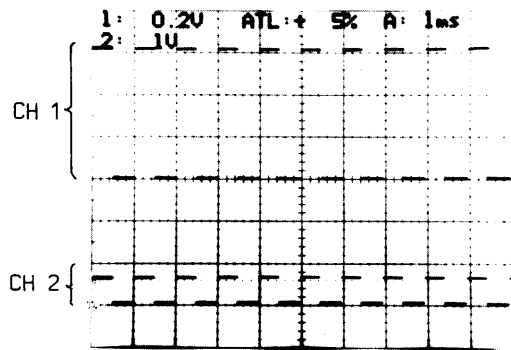

MODE Setting

Every time **MODE** key is pressed, the mode is switched as in the following.

At storage off (real)

When TIME/DIV is set at faster than 0.1 s.

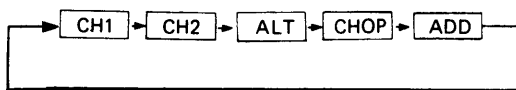

(1) Observe in **ALT** mode

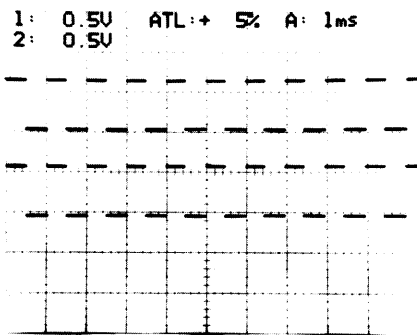

(2) Observe the waveform in **ADD** (CH 1 + CH 2) mode

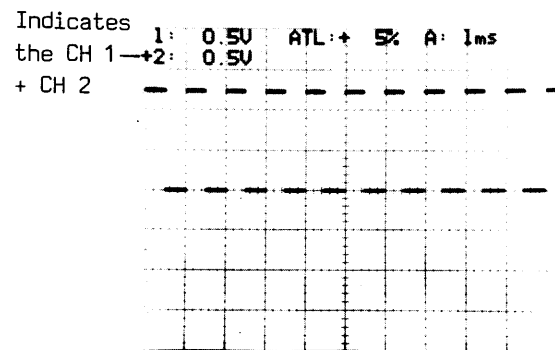

CH 2 POLAR Setting

Every time **CH 2 POLAR** key is pressed, CH 2 POLAR is switched. When **INV** glows, CH 2 polarity is inverted.

(3) Observe with the same settings as in (2),

but **CH 2 POLAR** set at INV (CH 1 - CH 2).

Indicates that CH 2 POLAR is set at INV

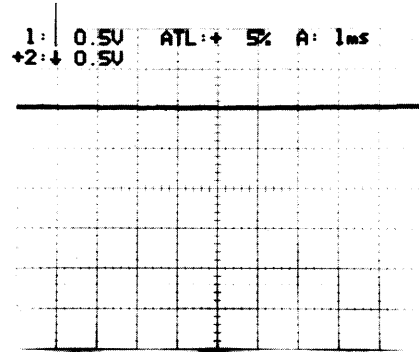

(4) Observe the waveform of (1) in CH 1 mode.

Indicates that the waveform of CH 2 is not shown

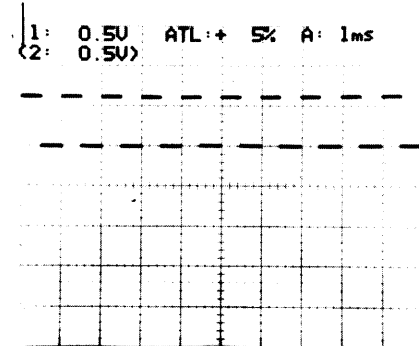

Roll Mode

When TIME/DIV is set to slower than 0.2 s (roll mode), the MODE is switched as in the following.

As to ROLL mode, see **TIME/DIV** setting.

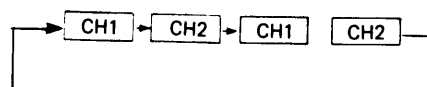

(5) Observe with the setting of TIME/DIV at 1 s

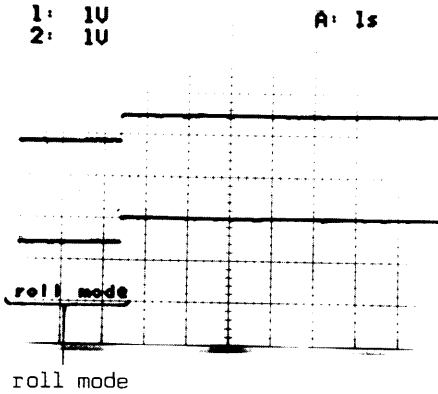

2) When VARIABLE is set

Shows that UNCAL is selected

1: >0.2U ATL:+ S% A: 1ms
(2: 0.5U)

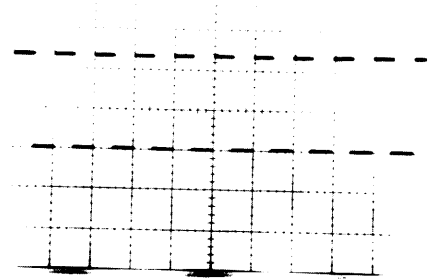

At storage on

With STORAGE ON, the mode is switched as in the following:

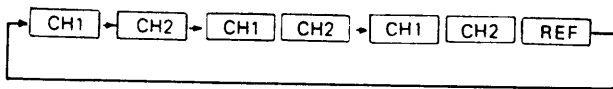

As to REF, see GUIDE MENU (3).

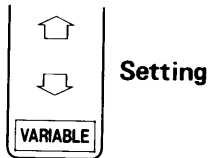

When **2nd FUNC** is switched to ON, VOLT/DIV goes

off, and **VARIABLE** glows; setting of VARIABLE is now possible.

When \downarrow is pressed, the deflection factor decreases and UNCAL lamp glows. when it is kept pressed to reach the final value, "LMT" blinks at upper left corner of the CRT. When \uparrow is pressed, the deflection factor increases.

1) When VARIABLE is not set

1: 0.2U ATL:+ S% A: 1ms
(2: 0.5U)

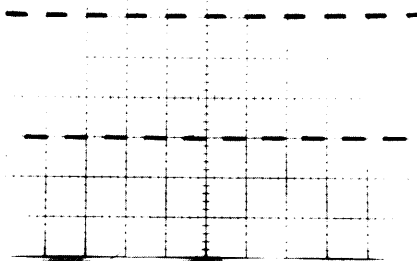

Shows the final value

1: >0.2U ATL:+ S% A: 1ms
(2: 0.5U)
LMT

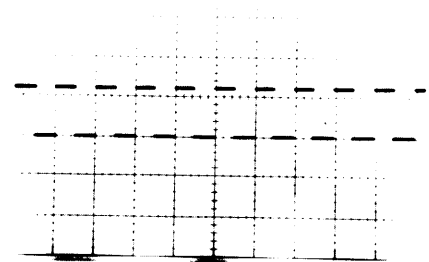

BAND WIDTH

Setting

Every time **BAND WIDTH** key is pressed, the bandwidth

20 MHz limiter is switched between ON and OFF.

3-3 TRIGGERING

SOURCE Setting

A SOURCE

When **A** is glowing, A SOURCE can be set.

Every time **SOURCE** key is pressed, it is switched as in the following.

- At **STORAGE OFF**

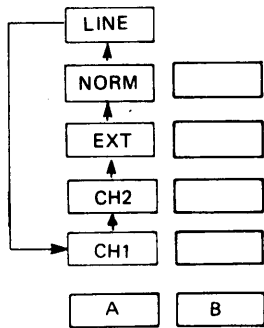

- At **STORAGE ON**

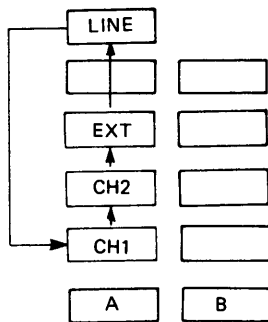

B SOURCE

When the following setting is made, **A** goes off and **B** glows and the setting of B Source becomes possible.

2nd FUNC : **ON**

HORIZ DISPLAY : **A INTEN**, **B (DLY'D)**, or **B (DLY'D)** (STORAGE OFF) / **A INTEN**

Every time **SOURCE** is pressed, it is switched as in the following.

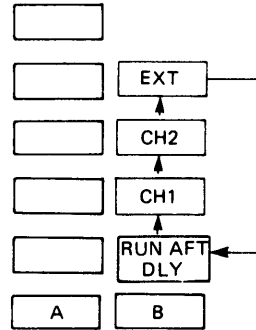

COUPLING Setting

A COUPLING

Setting is possible when **A** is glowing.

Every time **COUPLING** key is pressed, it is switched as in the following.

1) **HORIZ DISPLAY** : **A**

or

HORIZ DISPLAY : **A INTEN** , **B (DLY'D)** , **A INTEN**

SOURCE **B** : **RUNAFT DLY**

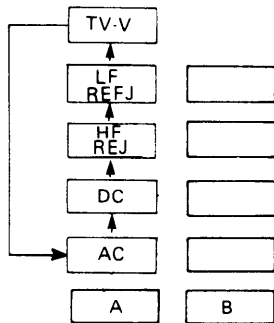

2) **HORIZ DISPLAY** : **A INTEN** , **B (DLY'D)** , **A INTEN**

SOURCE : **CH1** , **CH2** , **EXT**

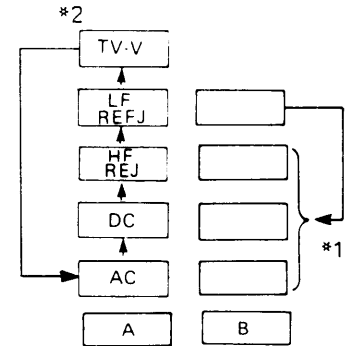

*1 Final setting of B.

*2 If TV-V is selected for A, TV-H is set for B.

B COUPLING

When the following setting is made, **A** of **COUPLING** goes off and **B** glows, and setting of B COUPLING is enabled.

2nd FUNC : **ON**

HORIZ DISPLAY : **A INTEN** , **B (DLY'D)** , **A INTEN**

SOURCE **B** : **CH1** , **CH2** , **EXT**

Every time **COUPLING** key is pressed, it is switched as in the following.

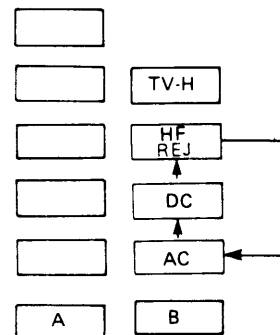

TV Signal Measurement

① Described below is a measurement example that applies when the following setting is made under TV signal input.

HORIZ DISPLAY A INTEN
 A SOURCE CH 1
 A SLOPE -
 A COUPLING TV-V
 B COUPLING TV-H is set automatically by setting A COUPLING to TV-V

1) Observe in A INTEN mode

1: 0.2V ATL:+ 5% A: 0.2ms
 <2: 0.1V> DTN: 2.718
 BTL:+ 5% B: 5μs

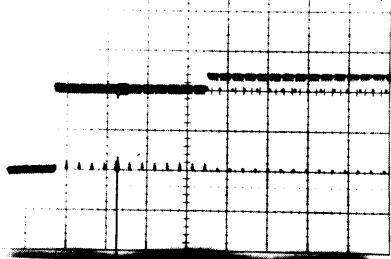

SWEEP B

② Set HORIZ DISPLAY to B (DLY'D), the following is displayed.

2) Observe in B (DLY'D)

1: 0.2V ATL:+ 5% (A: 0.2ms)
 <2: 0.1V> DTN: 2.718
 BTL:+ 5% B: 5μs

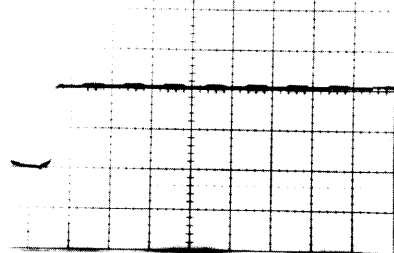

SLOPE Setting

A SLOPE

Setting is possible when **A** is glowing.

When the **SLOPE** key is pressed, it is switched between "+" and "-".

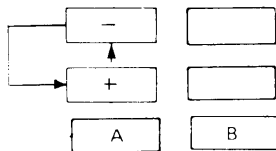

1) "+" SLOPE of A

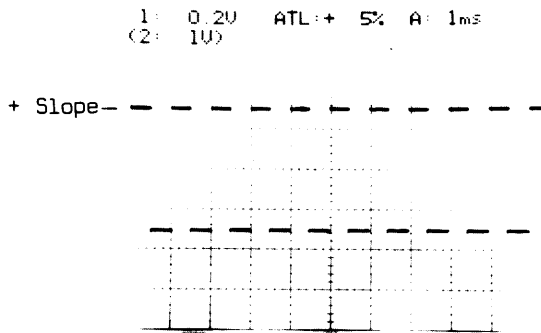

2) "-" SLOPE of A

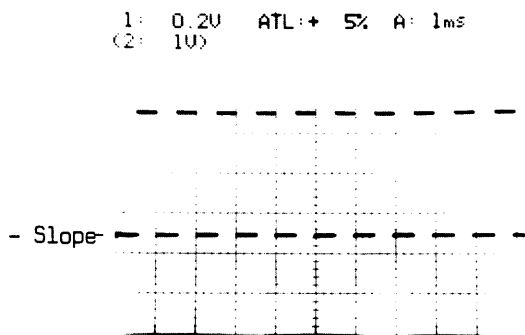

B SLOPE

When the following setting is made, **A** of **SLOPE** goes off and **B** glows, and setting of B SLOPE is enabled.

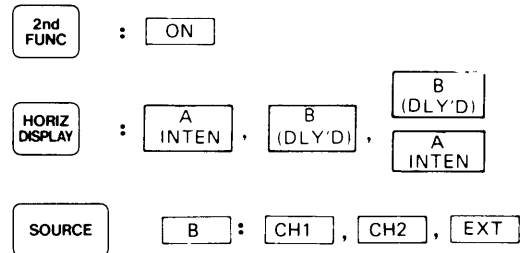

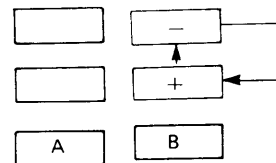

Every time **SLOPE** key is pressed, it is switched between "+" and "-".

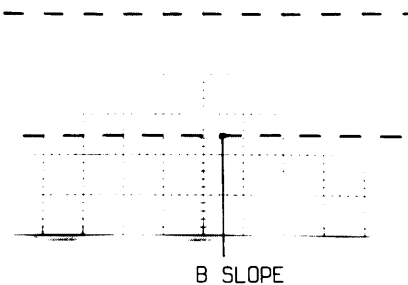
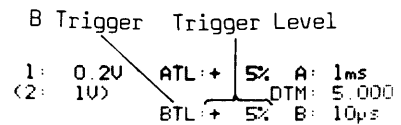

3) "-" SLOPE of B



LEVEL
Setting

Every time  of  key is pressed, the level increases and reaches the final value +100%.

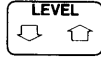
Each time  of  key is pressed, the level decreases and reaches the final value -100%.

When the final value is reached, "LMT" blinks at upper left corner of the CRT.

For both CH1 and CH2, ±100% corresponds to the reading of approx. ±6 div.

A LEVEL

Setting is possible when  is glowing.

Described below are measurement examples when A TIME/DIV is set at 0.5 μs.

1) Initial Setting

A LEVEL (Initial Set Value)

1: 0.2U ATL: + 5% A: 0.5μs
(2: 1U)

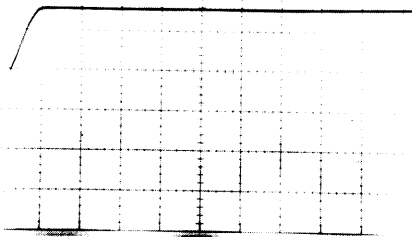

2) A LEVEL is set at +25% by pressing 

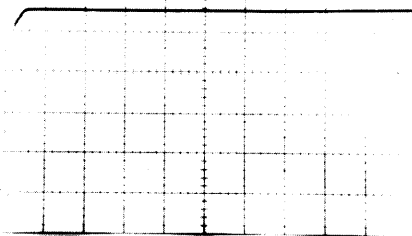

A LEVEL
1: 0.2U ATL: + 25% A: 0.5μs
(2: 1U)



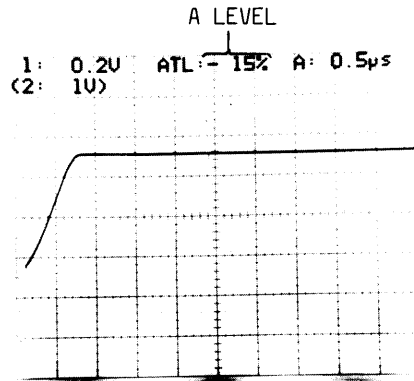





3) A LEVEL is set at -15% by pressing 







B LEVEL

When the following setting is made,  goes off and  glows, and setting of B LEVEL is enabled.

 : 

 :  ,  ,  , 

  :  ,  , 

Described below are measurement examples when A TIME/DIV is set at 1 ms, and B TIME/DIV is set at 0.5 μs.

1) Initial Setting

B LEVEL (Initial Set Value)

1: 0.2U ATL: + 5% (A: 1ms)
(2: 1U) DTM: 5.000
BTL: + 5% B: 0.5μs

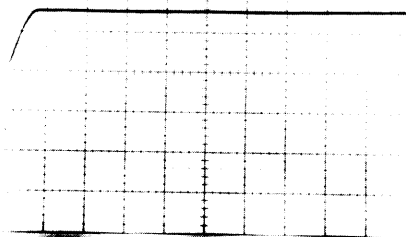

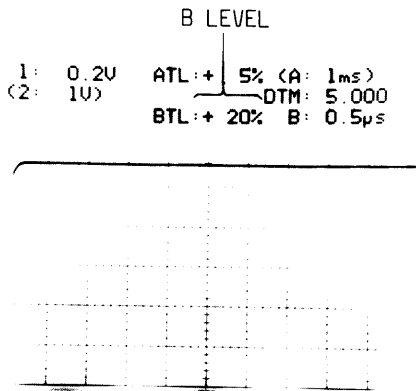

2) B LEVEL is set at to +20% by pressing 

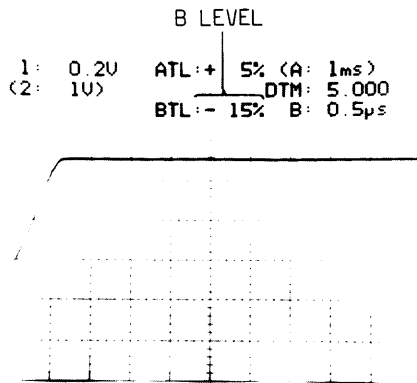

3) B LEVEL is set at -15% by pressing 



Setting

When  is pressed, holdoff time is increased and reaches the set ultimate value of 100%. When  is pressed, holdoff time is decreased and reaches the final value 0%, at which time nothing is displayed on the CRT.

When the final value is reached, "LMT" blinks at the upper left corner of the CRT.

Below is an example with a periodic signal (TV signal) input.

1) HOLD OFF 0%

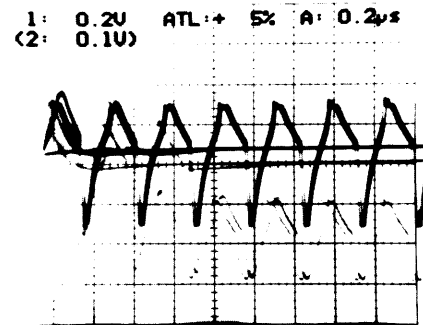

2) HOLD OFF 83%

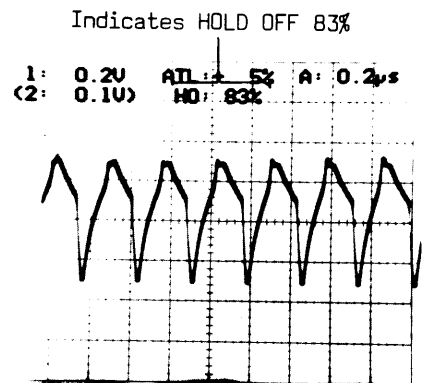

3-4 HORIZONTAL SYSTEM

SWEEP MODE Setting

Every time **SWEEP MODE** key is pressed, the mode is switched as in the following.

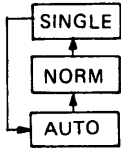

AUTO: The trigger level can be set by **LEVEL** .

Triggering is possible when the trigger level is set within the trigger level range. Auto sweep is performed when the trigger level is out of the trigger level range or when there is no trigger signal, facilitating observation of small-amplitude signals or of ground potential by setting the GND input coupling. Triggering is not possible with frequencies of 50 Hz or less. In such case, use the NORMAL mode described below.

NORM: Similarly to the AUTO mode, triggering is possible when the trigger level is set within the trigger level range. However, when the trigger level is out of the trigger level range or when there is no trigger signal, sweeping is not performed.

SINGLE: Triggering is applied only once. Press **SINGLE RESET** once to stand by for the sweep start. When trigger is ready and A TRIG'D lamp is lit, pressing it again performs one single sweep.

HORIZ DISPLAY Setting

Every time **HORIZ DISPLAY** key is pressed, it is switched as in the following.

STORAGE OFF (REAL)

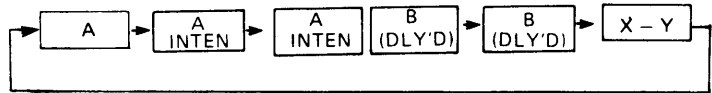

STORAGE ON

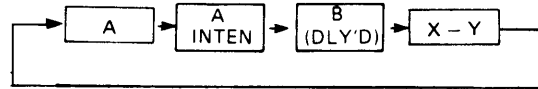

A Operation

A **TIME/DIV** Setting

Every time **TIME/DIV** is pressed, sweep time becomes faster in a 1-2-5 sequence and reaches the final value 20 ns/DIV.

Every time **TIME/DIV** is pressed, sweep time slows down in a 1-2-5 sequence and reaches the final value 10 s/DIV.

When the final value is reached, "LMT" blinks at the upper left corner of the CRT.

ROLL MODE Setting

When using in ROLL mode, the following setting should be made.

STORAGE	OFF (REAL)
HORIZ DISPLAY	A
TIME/DIV	Slower than 0.2 s/DIV

If the waveform is to be frozen, switch **FREEZE** to ON.

1) Sweep time of initial state

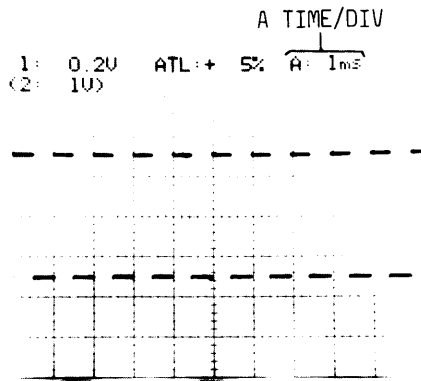

2) When seep time is increased

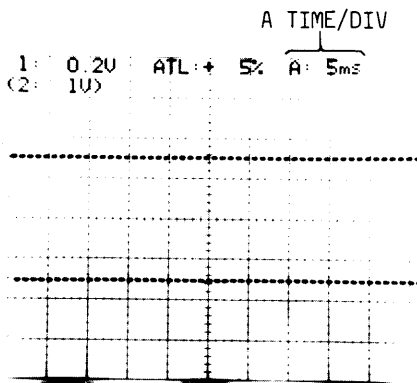

3) When sweep time is decreased

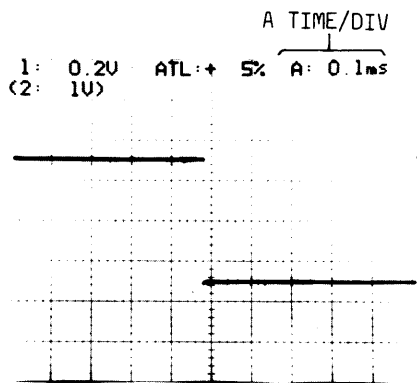

EXT CLOCK Setting

If TIME/DIV is set to EXT in the STORAGE mode, waveforms can be triggered in by external clocks.

If a clock input pause continues longer than about 300 ms, the message NO CLOCK is displayed on the CRT screen.

If a clock slower than 300 ms is input, the message NO CLOCK blink synchronously with the external clock, but this does not adversely affect storage operation at all.

The input terminal is located on the rear panel. Set the STORAGE-REAL select switch on the rear panel to the STORAGE position.

ROLL mode

When an input signal is written with a clock repeated slowly (in the slow range of TIME/DIV), it takes considerable time to complete write operation, and observation of input signals during that period is not possible. The instrument solves such trouble by employing ROLL mode in the range 0.2 s to 10 s/DIV.

In ROLL mode, each time a clock writes data of one word-length, the newest data are displayed at the right end of the CRT. Each time subsequent data are inputted, the previous data is moved by one word-length towards the left side of the CRT. Input signal can thus be confirmed upon writing.

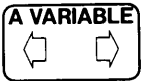

Setting

When of A VARIABLE is pressed, the sweep time decreases, and UNCAL glows. When it is further pressed till the sweep time reaches the final value, "LMT" blinks at the upper left corner of the CRT.

When is pressed, the sweep time is decreased. When the sweep time reaches the CAL state. UNCAL goes off and "LMT" blinks at the upper left corner of the CRT.

1) Setting of VARIABLE

Shows that it is in UNCAL state

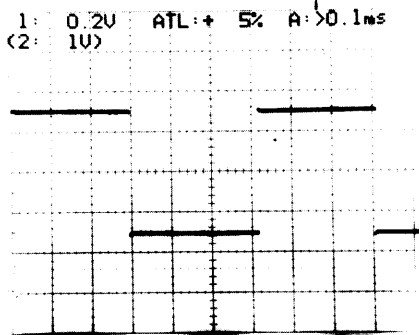

Setting

Every time key is pressed, magnification is switched between on and off.

1) X10 MAG OFF

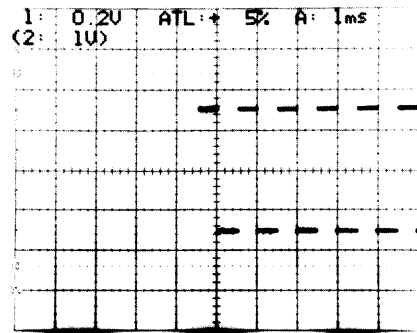

When is pressed with the setting above,

the signal is horizontally magnified from the center of the CRT.

2) X10 MAG ON

Sweep time is multiplied by 10

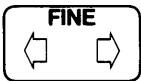
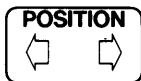
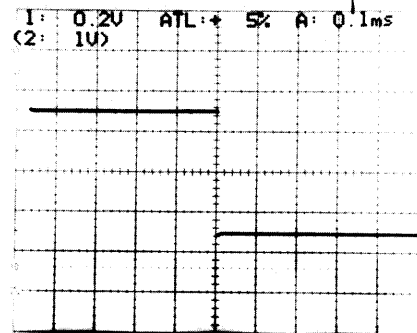

(Horizontal Position) Setting

When of or is pressed, the trace moves towards left, and when is pressed, towards right.



key is used for coarse and

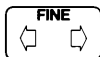

for fine adjustment.

When the trace reaches the final position, "LMT" blinks at the upper left corner of the CRT.

A INTEN Operation

From state 1) of **A**, set at A INTEN.

1) A INTEN

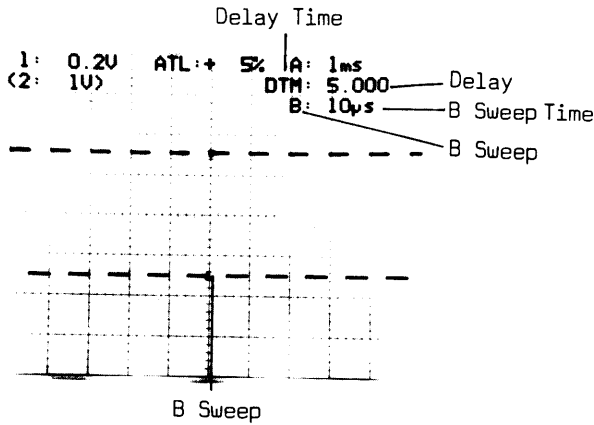

B SOURCE Setting when A INTEN and STORAGE ON are selected

Even when B TRIGGER SOURCE is set at CH 1, CH 2, or EXT, TRIGGERED DELAY is not performed and works just as when RUNS AFTER DELAY is selected. However, when B DLY'D is set, TRIGGERED DELAY is performed.

Caution

B SOURCE Setting when A INTEN and STORAGE ON are selected

Even when B TRIGGER SOURCE is set at CH 1, CH 2, or EXT, TRIGGERED DELAY is not performed and works just as when RUN AFTER DELAY is selected. However, when B DLY'D is set, TRIGGERED DELAY is performed.

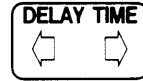

Setting

When is pressed, delay time increases and reaches the ultimate value of 10.238. When is pressed, the delay time decreases and reaches the final value 0.200. When the final value is reached, "LMT" blinks at the upper left corner of the CRT.

2) Decrease delay time

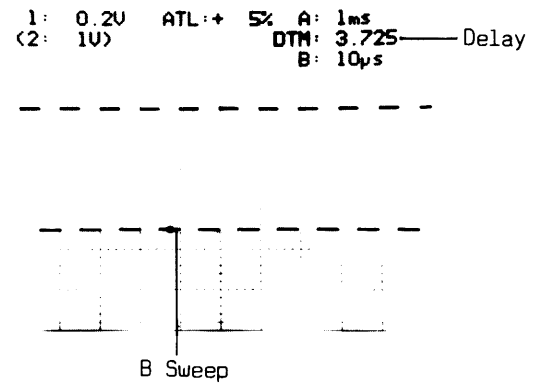

3) Increase delay time

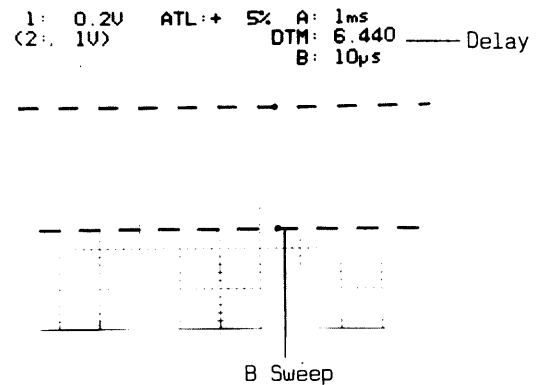

B **TIME/DIV** Setting

When **2nd FUNC** is switched to ON, **A** **TIME/DIV** goes off and B glows, and setting of B sweep is enabled.

When \leftarrow is pressed, the sweep becomes fast, and when \rightarrow is pressed, slowed down. When the sweep time reaches the final value, "LMT" blinks at the upper left corner of the CRT.

A INTEN & B (DLY'D) Operation

When **B (DLY'D)** & **A INTEN** are selected from state 1) of **A INTEN**, waveforms with **A INTEN** and **B (DLY'D)** are displayed superimposed.

1) **A INTEN**, **B (DLY'D)**

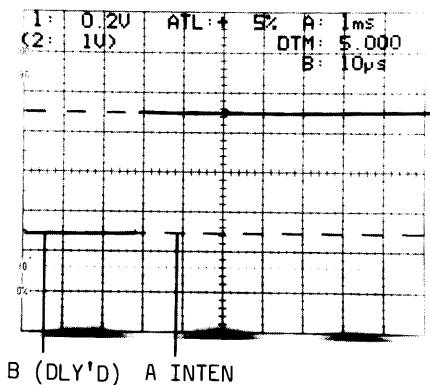

TRACE SEPARATION Setting

when \uparrow of **TRACE SEPARATION** is pressed while the figure shown above is displayed, the waveform with B (DLY'D) moves upwards. When it reaches the final position, "LMT" blinks at upper left corner of CRT.

When \downarrow is pressed under the same condition, the waveform with B (DLY'D) moves downwards. When it reaches the position shown in the figure above, "LMT" blinks at the upper left corner of the CRT, and the waveform will not move further.

2) **TRACE SEPARATION** Setting

1: 0.2U ATL:+ 5% A: 1ms
(2: 1U) DTM: 5.000
B: 10µs

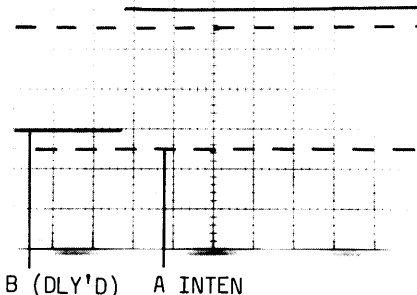

B (DLY'D) Operation

When **HORIZ DISPLAY** is pressed when 1) **A INTEN** & **B (DLY'D)** are selected, only **B (DLY'D)** glows and only the waveform with **B (DLY'D)** selected is displayed.

1: 0.2U ATL:+ 5% (A: 1ms)
(2: 1U) DTM: 5.000
B: 10µs

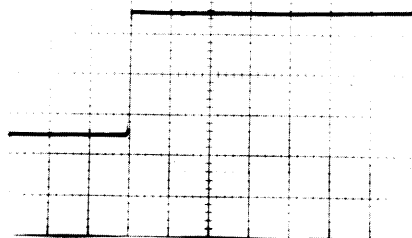

3-5 STORAGE

Every time **STORAGE** is pressed, it is switched between ON and OFF (REAL).

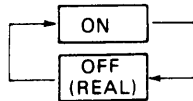

AUTO or NORM

Repeats write and read operations. If the written waveform is to be left displayed on the

CRT, press **FREEZE** to ON. When **FREEZE** is

activated, new write operation cannot be conducted, and the stored waveform is kept displayed on the CRT.

SINGLE

WRITE operation is conducted only once.

FREEZE Setting

Every time **FREEZE** is pressed, it is switched between on and off.

Note to FREEZE

FREEZE key is pressed when an inputted signal entered into CH 1 or CH 2 is to be written into memory and the signal is to be stored as it is. When FREEZE is activated, ON glows and the locked state results. In this state, write operation cannot be done even if a new signal is inputted.

Note on FREEZE Indicator

In the following case, FREEZE LED glows even when STORAGE is OFF (REAL).

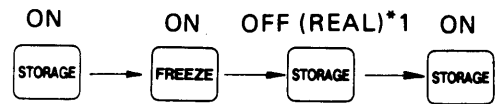

*1 Even when the STORAGE is in REAL mode, FREEZE LED is glowing.

Note on STORAGE status indicator.

When LEVELs are "H", indicator lamps on the front panel are illuminated.

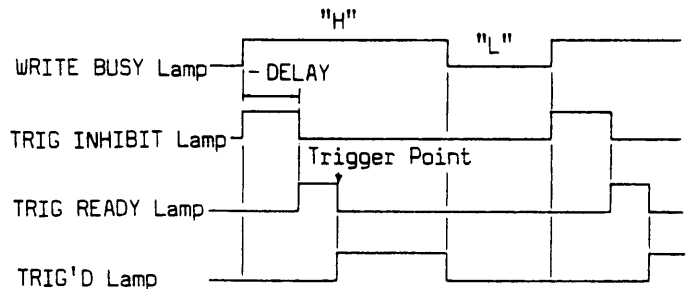

DATA POSITION Setting

When **STORAGE** is switched to **ON**, **DATA POSITION** is activated.

Every time **DATA POSITION** is pressed, it is switched as in the following.

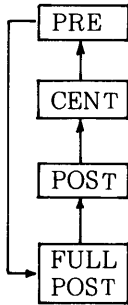

1) FULL POST (DELAY 0)

1: 0.2U ATL:+ 0% A: 10µs
(2: 1U)

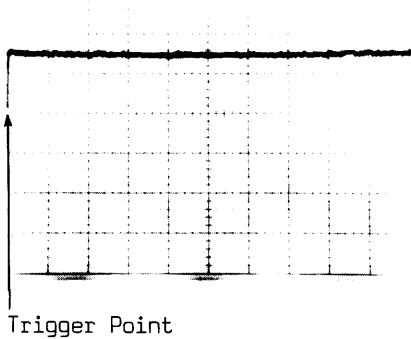

3) CENT (DELAY -4/8)

1: 0.2U ATL:+ 0% A: 10µs
(2: 1U)

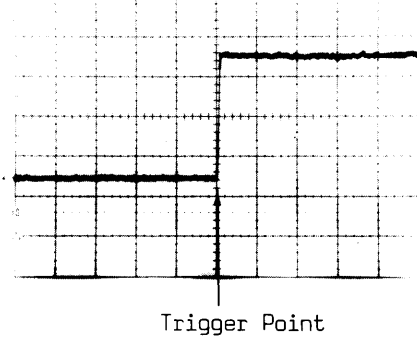

2) POST (DELAY -1/8)

1: 0.2U ATL:+ 0% A: 10µs
(2: 1U)

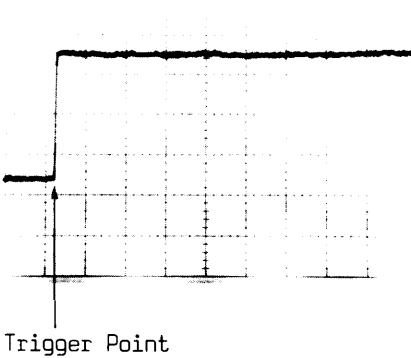

4) PRE (DELAY -7/8)

1: 0.2U ATL:+ 0% A: 10µs
(2: 1U)

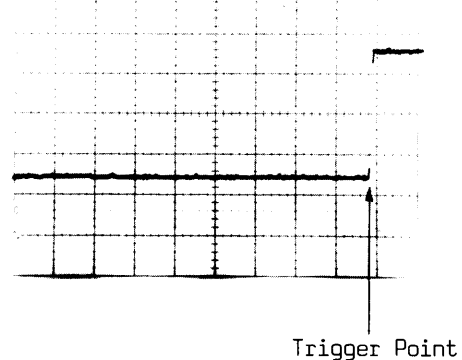

CAUTION

*If DATA POSITION has been reset in the trigger signal wait mode (by setting the SWEEP MODE to SINGLE and pressing **SINGLE RESET** button), press the **SINGLE RESET** button again.*

Waveform Magnification

Magnification and reduction are possible in storage mode. Setting range is as follows.

VOLTS/DIV 1/10 to 10 times
 TIME/DIV 1 to 100 times

Caution

Note on !SET UP! Display

If change of setting is performed over the above range, the sign !SETUP! is displayed on the upper left corner of the CRT. When this sign appears, the numerical values on the CRT can be changed according to the change in settings, but the waveform does not change.

B sweep Magnification

B sweep magnification is possible in storage mode.

- 1) A INTEN

1: 0.5V ATL+ 5% A: 1ms
 (2: 0.1V)

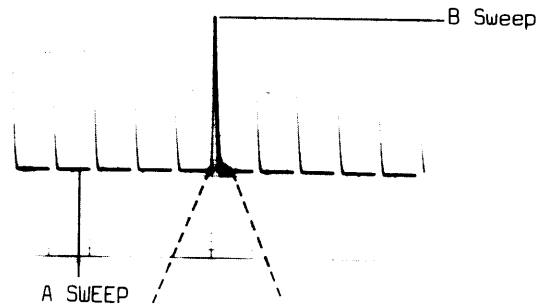

- 2) B (DLY'D)

1: 0.5V ATL+ 5% (A: 1ms)
 (2: 0.1V) DTM: 1.900
 B: 50µs

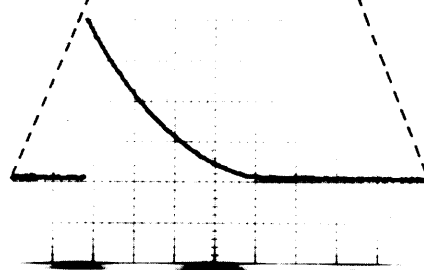

3-6 X-Y OPERATION

Operations when the STORAGE is set at ON are shown below.

Vertical MODE	Operations
CH 1	X axis: data of CH 1 currently captured Y axis: data of CH 2 captured last
CH 2	X axis: data of CH 1 captured last Y axis: data of CH 2 currently captured
CH 1 & CH 2	X axis: data of CH 1 currently captured Y axis: data of CH 2 currently captured

**HORIZ
DISPLAY**

At A

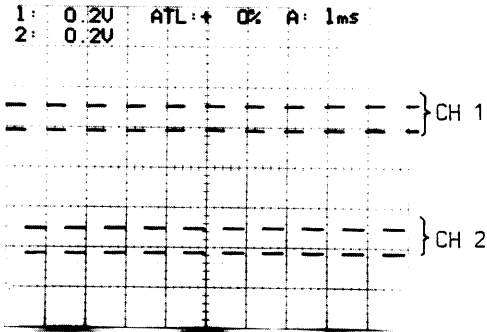

When **HORIZ DISPLAY** is set at **X-Y**, the following is displayed.

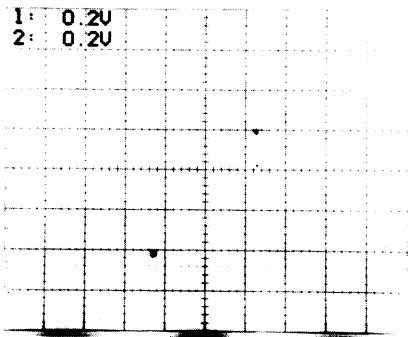

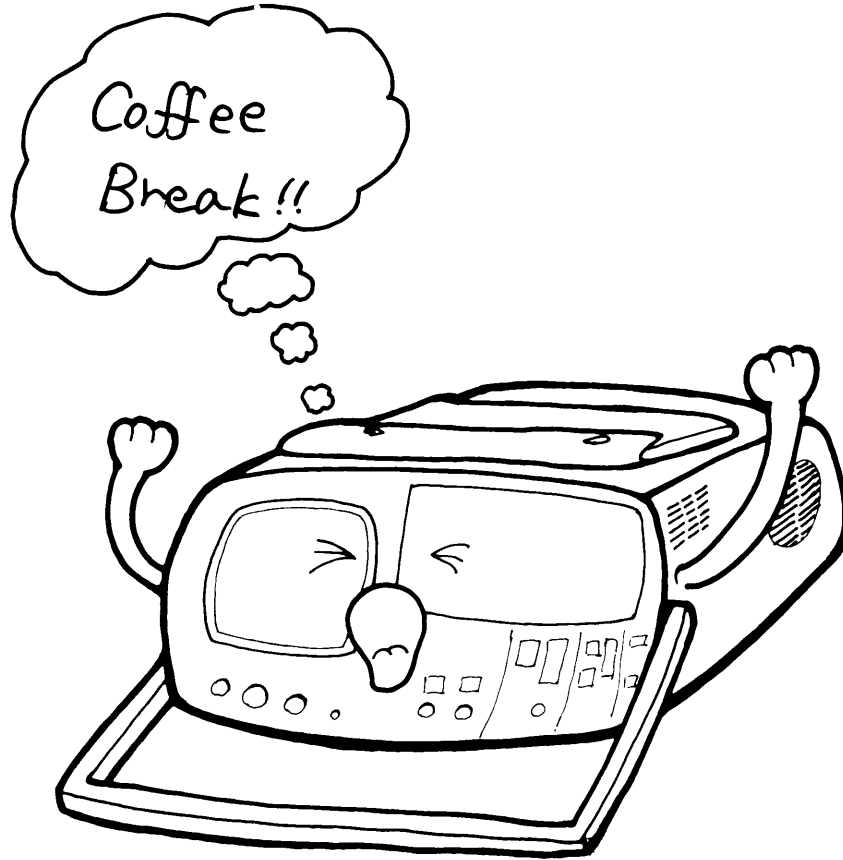

DS-6121

See pages (3-25 to 3-63)

DS-6121A

See pages (3-65 to 3-107)

DS-6121

3-7 GUIDE MENU

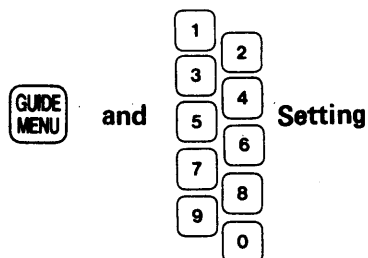

When **GUIDE MENU** is pressed, GUIDE MENU as shown in the following display appears on the screen. The number of FUNCTIONS to be used is selected from 1) to 9).

- 1) MEASUREMENT BY CURSORS
- 2) SETUP RECALL/SAVE
- 3) WAVEFORM RECALL/SAVE
- 4) AVERAGING
- 5) EQU-SAMPLING
- 6) CURVE INTERPOLATION
- 7) +-X
- 8) GO/NO GO
- 9) WAVEFORM OUT

1) Measurement by Cursors

Cursor measurement can be performed in either the real-time or the storage mode.

2) Setup recall/save

Used for saving and recalling setup (setting on the front panel). Up to four setups can be saved.

3) Waveform recall/save

Used for saving or recalling waveform data. Up to four waveforms can be saved; these waveforms can be compared.

4) Averaging

Eight setting levels are provided, enabling averaging from 2 up to 256 times.

5) Equivalent sampling

Continuous waveforms of up to 100 MHz can be sampled in order and digitized.

6) Curve Interpolation

This mode is for the interpolation of curves.

7) + - x Calculation

Addition, subtraction or multiplication can be performed in this mode.

8) GO/NO GO Judgement

Mainly used when judging whether a phenomenon is acceptable or not. The judgement range can be set by two methods, using cursors and waveforms.

9) Waveform Output

The on-screen data can be output to an X-Y recorder or plotter. The speed of the waveform output to the X-Y recorder can be controlled, and its scale can be output.

And then select necessary key from 1) to 0) according to Guide Menu Free.

Guide Menu Tree

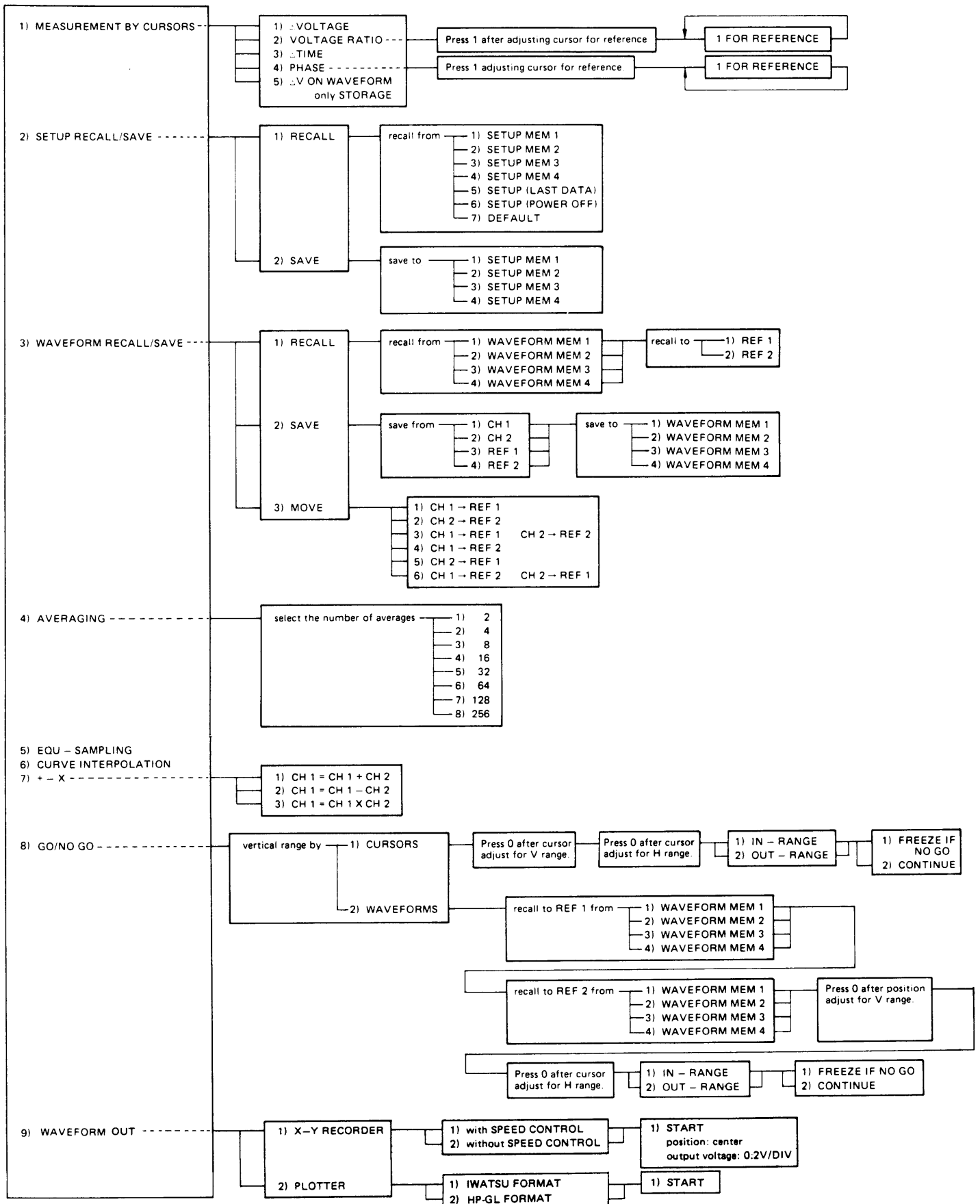

Usage Range

MENU NO.	STORAGE	
	OFF (REAL)	ON
1	Δ^{*1}	○
2	○	○
3	ERR 7	○
4	ERR 7	○
5	ERR 7	Δ^{*2}
6	ERR 7	○
7	ERR 7	○
8	ERR 7	○
9	ERR 7	○

*1 Except ΔV ON WAVEFORM

*2 Effectuated when TIME/DIV is set at faster than 2 $\mu\text{s}/\text{DIV}$ in the case of CH1 only, and faster than 5 $\mu\text{s}/\text{DIV}$ in the case of CH1 and CH2.

Error Messages

When non-allowable setting from GUIDE MENU was selected, an error message appears on the screen.

Error Number	Description
ERR 1	Non-selectable FUNCTION was selected while performing measurement by cursors
ERR 3	Non-selectable FUNCTION was selected while performing EQU-SAMPLING
ERR 4	Non-selectable FUNCTION was selected while performing curve interpolation
ERR 5	Performing +, -, x
ERR 6	Performing GO/NO, GO
ERR 7	Non-selectable FUNCTION was selected which cannot be performed under present SETUP conditions
ERR 8	Non-selectable FUNCTION was selected while performing AVERAGING
ERR 9	Interface unit is not connected while performing PLOTTER OUTPUT

List of Functions Which can be Selected in Combination

The following table shows whether or not a particular F1 MENU item can be selected simultaneously with a particular F2 item.

		F2								
		1) MEASUREMENT BY CURSORS	2) SETUP RECALL/SAVE	3) WAVEFORM RECALL/SAVE	4) AVERAGING	5) EQU-SAMPLING	6) CURVE INTERPOLATION	7) + - X	8) GO/NO GO	9) WAVEFORM OUT
F1	1) MEASUREMENT BY CURSORS									
	2) SETUP RECALL/SAVE									
	3) WAVEFORM RECALL/SAVE									
	4) AVERAGING	○	○	○		○	○	○	○	○
	5) EQU-SAMPLING	○	○	○	○		○	○	○	○
	6) CURVE INTERPOLATION	○	○	○	○	○		○	○	○
	7) + - X	○	○	○	○	○	○		○	○
	8) GO/NO GO		○	*1	○	○	○	○		○
	9) WAVEFORM OUT									

○ : F2 can be selected while any item of F1 is being executed.

*1 SAVE can be performed simultaneously but RECALL should be performed with other modes.

Quit of Guide Menu

- QUIT LOCAL key is used for clearing FUNCTION selected from GUIDE MENU.
 - Selecting multiple FUNCTIONS from GUIDE MENU and pressing QUIT LOCAL after completion of operating, all FUNCTIONS is cleared.
 - Selecting multiple FUNCTIONS from GUIDE MENU and pressing QUIT LOCAL during operating, only one FUNCTION selected last is cleared.
- Clearing a particular FUNCTION find its (OFF) display in GUIDE MENU and press the relevant numerical key with the corresponding function number.

- 1) MEASUREMENT BY CURSORS
- 2) SETUP RECALL/SAVE
- 3) WAVEFORM RECALL/SAVE
- 4) AVERAGING
- 5) EQU-SAMPLING
- 6) CURVE INTERPOLATION<OFF> ——— When 7 is pressed, only 7) curve interpolation is cleared.
- 7) + - X
- 8) GO/NO GO
- 9) WAVEFORM OUT

3-7-1 MEASUREMENT BY CURSORS

MENU

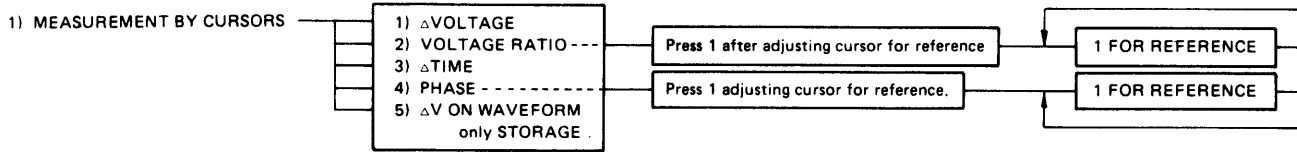

Using two cursors, Δ voltage, voltage ratio, Δ time, phase and ΔV on waveform are measured.

Adjust the cursor position for measurement with CURSOR 1 and CURSOR 2.

When cursors are moving, the sign "WORKING" appears at the bottom of the CRT. Upon completion of cursor setting, "WORKING" sign disappears and the value measured as the separation between the two cursors appears at the lower right corner of the CRT.

The Difference between Δ VOLTAGE and ΔV ON WAVEFORM

① Functional Difference

Δ VOLTAGE: Irrelevant to the waveforms, potential difference between the two cursors is calculated and shown on the CRT screen.

ΔV ON WAVEFORM: Potential difference is calculated on the basis of captured waveform data and shown on the CRT screen.

② Difference Upon Use

Δ VOLTAGE: Absolute voltage value can be measured if one of the cursors is fixed at the GND line upon measurement.

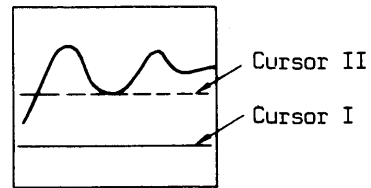

ΔV ON WAVEFORM: In the case as shown in the following figure, the peak value can be measured without moving the cursors even when the waveform amplitude fluctuates.

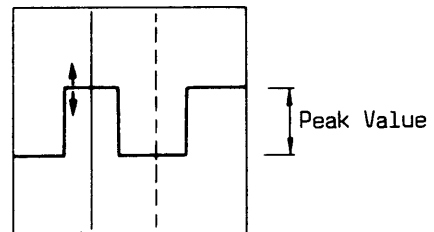

Described below is the example of measurement with CAL input and the following settings.

V. MODE CH 1
 VOLTS/DIV 0.2 V
 A TIME/DIV 0.2 ms

Press **1** while GUIDE MENU is displayed, and displays a figure as shown in Figure 3-7-1.

Next, press the numerical key **1** to **5** to select FUNCTION for the measurement.

Figure 3-7-1. Example of Measurement by Cursors

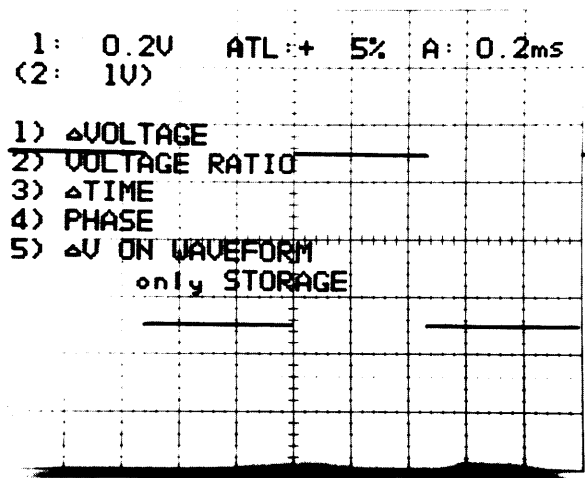

3-7-1-1 Δ VOLTAGE

Measures potential difference between two cursors. When the cursor 2 is upper and the cursor 1 lower, indicates "+". When the Y axis deflection factor is uncal, indicates a unequal mark ">" or "<".

Procedure

- ① Press 1 while Figure 3-7-1 is displayed.
- ② Adjust the cursors positions for measurement with two cursors. Measured results are displayed at the lower right corner on the CRT.

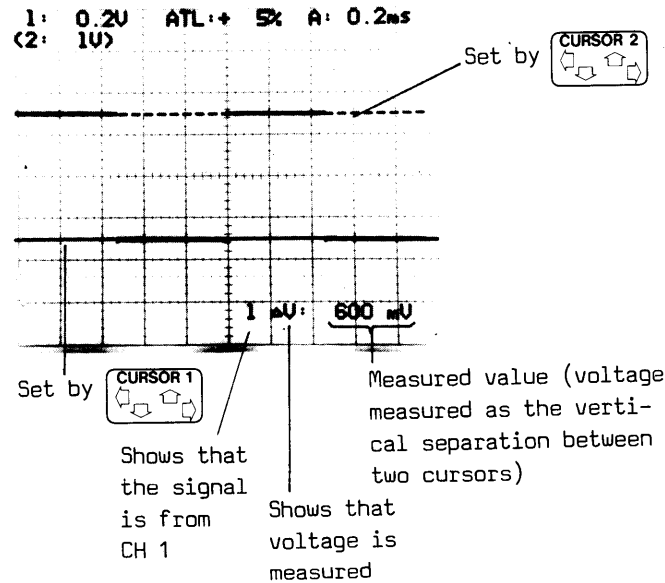

Unit and Unequal mark

Refer to table below.

STORAGE	Measuring Item	Unit	Measuring Result	
			+	-
OFF (REAL)	Except ADD	V	>	<
	ADD	div		
ON	Except +-x	V	>	<
	+-x	div		

Caution

The sign is positive when the Cursor 1 is in the lower half of the screen.
 The sign ">" is displayed when Y axis sensitivity is set at UNCAL.

3-7-1-2 VOLTAGE RATIO

The potential difference between the standard cursor positions set prior to the measurement is defined as 0 dB and 100%. The ratio of the voltage calculated against this standard difference for CH 1 or CH 2 measured by the two cursors is to be displayed both in percent (%) and in decibels (dB).

Procedure

- ① Press **2** while Figure 3-7-1 is displayed.
- ② Adjust the cursor position for measurement with two cursors.

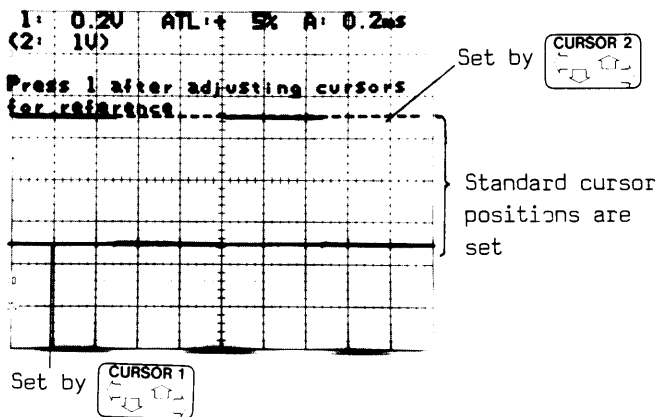

- ③ Press **1**, and the following is displayed (the value between two cursors are now set as 0.00 dB and 100%).

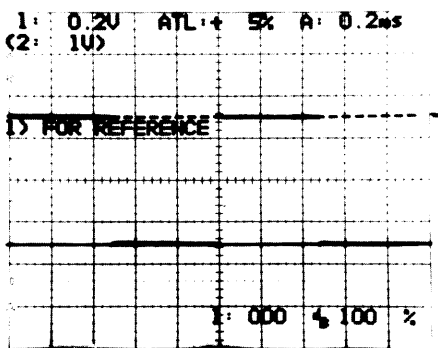

- ④ For example, when the position of CURSOR 2 is set as in the figure below with **4** of **CURSOR 2** key, it is compared with the standard potential difference set in operation ③ above and 1.92 dB and 124% are indicated on the screen.

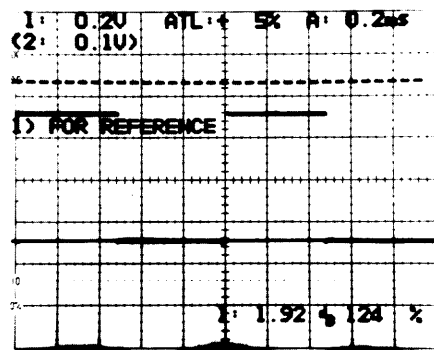

- ⑤ Press **4** again, and the values between two cursors are reset as 0.00 dB and 100%.

Unequal Mark

Refer to table below.

STORAGE	Measuring Item	Measuring Result			
		+		-	
		UNCAL → CAL	CAL→ UNCAL	UNCAL → CAL	CAL→ UNCAL
OFF (REAL)	Except ADD	>	<	<	>
	ADD				
ON	Except +-x	>	<	<	>
	+-x				

3-7-1-3 Δ TIME

The time difference two cursors and its reciprocal (frequency) are displayed in units of "s" and "Hz". Indicates "+" when the CURSOR 1 is on the left half of the screen.

Procedure

- ① Press 3 while Figure 3-7-1 is displayed.
- ② Adjust the cursor positions. Measured results are displayed at the lower right corner on the CRT.

Unequal Mark

Refer to table below.

Display	STORAGE	Measuring Result	
		+	-
Time display	OFF (REAL)	>	<
	ON		
Frequency display	OFF (REAL)	<	
	ON		

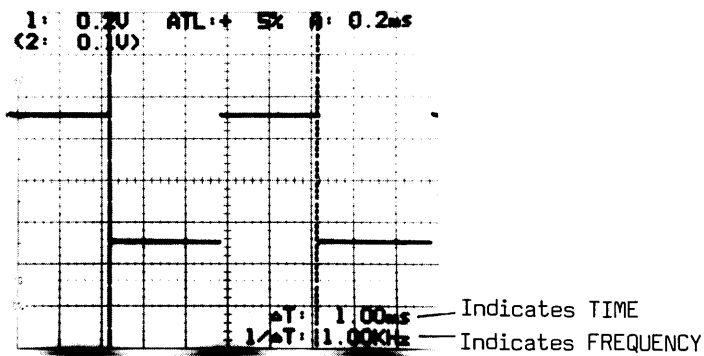

3-7-1-4 PHASE

One cycle of waveform is defined as 360 degrees and the phase measured by two cursors is displayed in unit of "degree". Indicates "+" when CURSOR 1 is on the left half of the screen.

Procedure

- ① Press **4** while Figure 3-7-1 is displayed.
- ② Adjust two cursors to bracket one cycle of waveform.

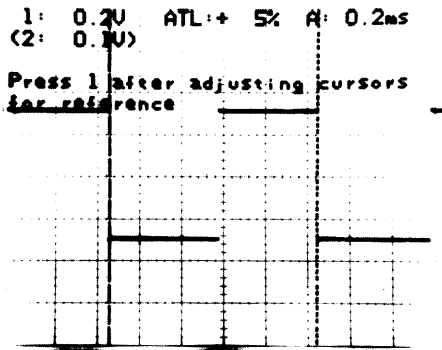

- ③ Press **1**, and the following is displayed. The phase between the two cursors are now defined as 360 degree.

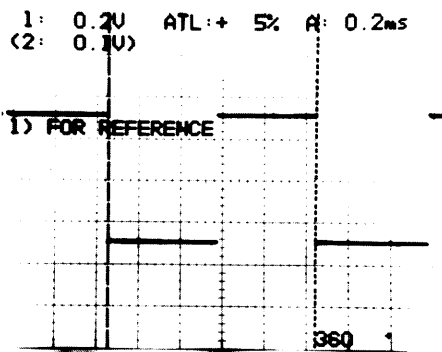

- ④ When the position of the CURSOR 2 is set as shown in the figure below by **1** of **CURSOR 2** key, the measured phase difference between the two cursors is indicated as 440 degree at the lower right corner of the CRT.

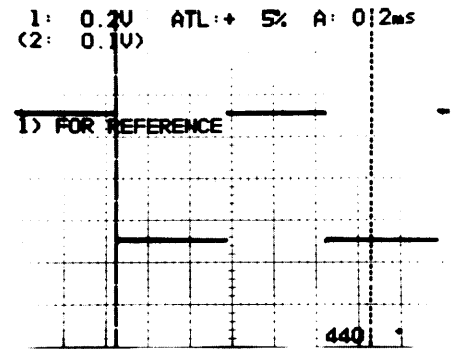

- ⑤ Press **1** again, and the value between two cursors in reset as 360 degree.

Unequal Mark

Refer to table below.

STORAGE	Measuring Result			
	+		-	
	UNCAL → CAL	CAL → UNCAL	UNCAL → CAL	CAL → UNCAL
OFF (REAL)	<	>	<	>
ON				

3-7-1-5 ΔV ON WAVEFORM

Measures potential difference between two waveform with two cursors.

Procedure

- ① Set **STORAGE** to ON.
- ② Press **5** while Figure 3-7-1 is displayed.
- ③ Adjust the cursor position for measurement with two cursors. Measured results are displayed at the low right corner on the CRT.

Caution

- *Effective even in arithmetic (+ - X) mode.*
- *x10 MAG mode is not allowed.*
- *Horizontal position is fixed at the center.*

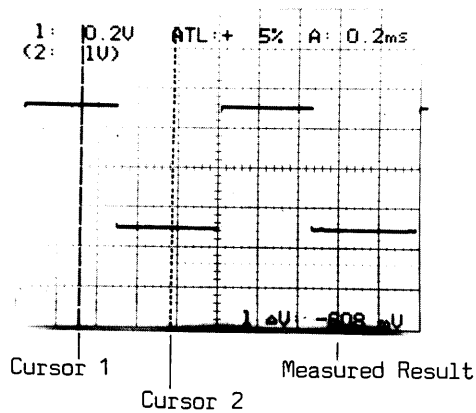

Unit and Unequal Mark

Refer to table below.

STORAGE	Measuring Item	Unit	Measuring Result	
			+	-
OFF (REAL)				
ON	Except +-x	V	>	<
	+-x	div		

3-7-2 SETUP RECALL/SAVE

MENU

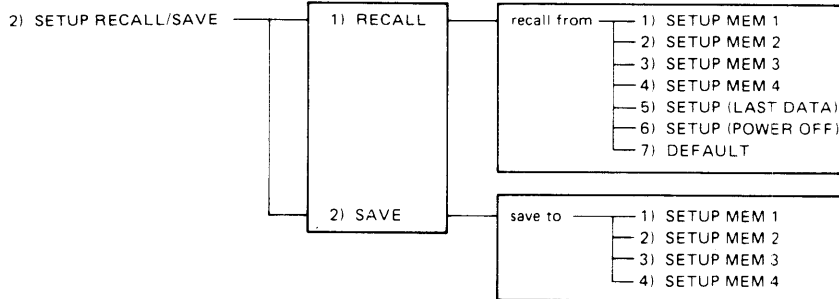

Settings made on the front panel can be saved in Memory 1 to 4 and recalled when necessary for confirmation. When LAST DATA, POWER OFF, or DEFAULT is selected, the relevant settings are automatically saved in memory, and can be recalled when necessary.

SETUP (LAST DATA): Settings made upon the last data entry while the power is on can be recalled even after the power is switched off.

SETUP (POWER OFF): Settings changed after the last data entry, for waveform magnification, etc., can be recalled even after the power is switched off.

SETUP (DEFAULT): Used for returning to the initial settings because of mistakes in setting, etc. Whenever the power is turned on, this DEFAULT setting is made.

The power for the memory is backed up by a battery.

Described below is example of operations concerning SAVE and RECALL of memory 1) to 4), RECALL of LAST DATA, POWER OFF, and DEFAULT under CAL input.

3-7-2-1 SAVE

Procedure I (Save to memory 1)

————— "SET UP State" Setting —————

- ① Display the waveform to be saved on the CRT.

Setting example:

V. MODE ALT
VOLTS/DIV 1 V
A TIME/DIV 5 ms

————— "SET UP RECALL/SAVE" Setting —————

- ② Press **2** while GUIDE MENU is displayed, and the following is displayed.

1) RECALL
2) SAVE

————— "SAVE" Setting —————

- ③ Press **2** again, and the following is displayed.

save to
1) SETUP MEM 1
2) SETUP MEM 2
3) SETUP MEM 3
4) SETUP MEM 4

————— "SAVE to" Selecting —————

- ④ Press **1**, and the following is displayed, and this waveform is saved in Memory 1.

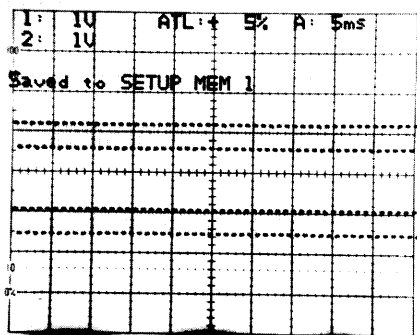

Procedure II (Save to memory 2)

- ① Display the waveform to be saved next on the CRT.

Setting example:

V. MODE ALT
VOLTS/DIV 1 V
A TIME/DIV 1 ms

- ② Operate as described in operation ②.
③ Operate as described in operation ③.
④ Press **2**, and the following is displayed (this waveform is saved in Memory 2).

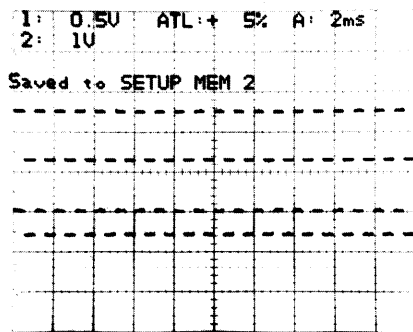

Procedure III (Save to memory 3)

Similarly, save the waveform with the following in Memory 3.

Setting example:

V. MODE ALT
VOLTS/DIV 0.5 V
A TIME/DIV 1 ms

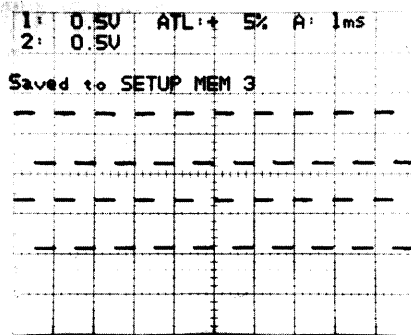

Procedure IV (Save to memory 4)

Similarly, save the waveform with the following setting in Memory 4.

Setting example:

V. MODE	ALT
CH 1 VOLTS/DIV	0.2 V
CH 2 VOLTS/DIV	0.5 V
A TIME/DIV	0.5 ms

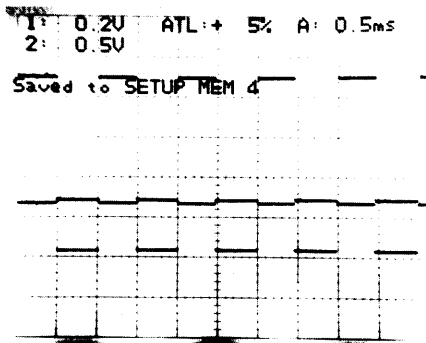

3-7-2-2 RECALL

Procedure

—————"SETUP RECALL/SAVE" Setting —————

- ① Press **2** while GUIDE MENU is displayed, and the following is displayed.

- 1) **RECALL**
- 2) **SAVE**

—————"RECALL" Setting —————

- ② Press **1**, and the following is displayed.

- ```
recall from
1) SETUP MEM 1
2) SETUP MEM 2
3) SETUP MEM 3
4) SETUP MEM 4
5) SETUP(LAST DATA)
6) SETUP(POWER OFF)
7) DEFAULT
```

—————"Recall from" Setting —————

- ③ Press the numerical key corresponding the number of data to be recalled.

Described below is each of the recalled waveform.

1) SETUP MEM 1

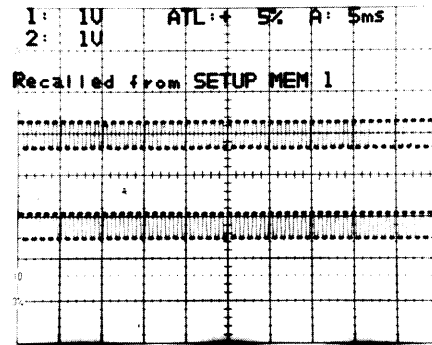

2) SETUP MEM 2

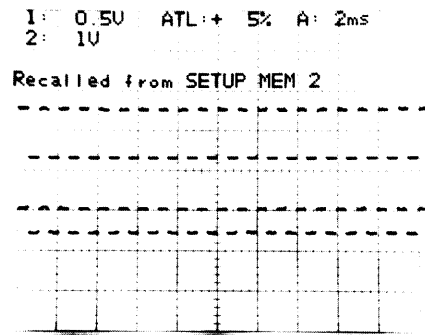

3) SETUP MEM 3

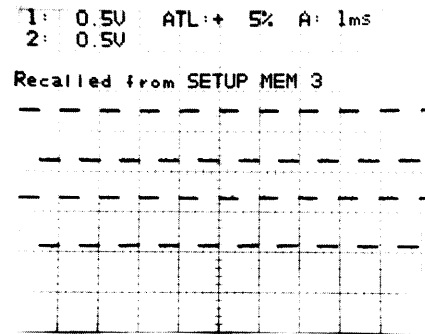

4) SETUP MEM 4

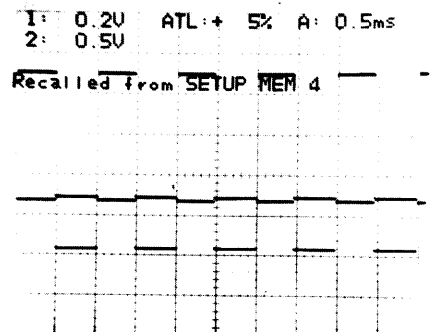

5) SETUP (LAST DATA)

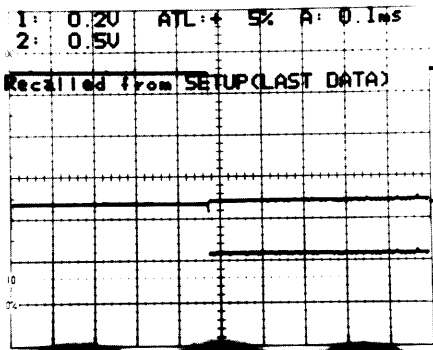

6) SETUP (POWER OFF)

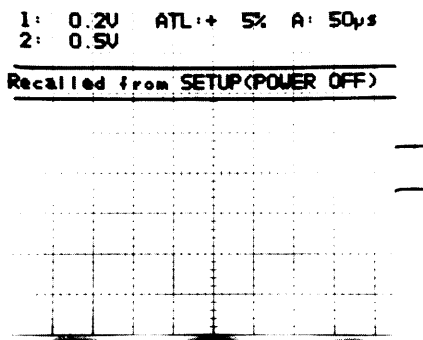

7) DEFAULT

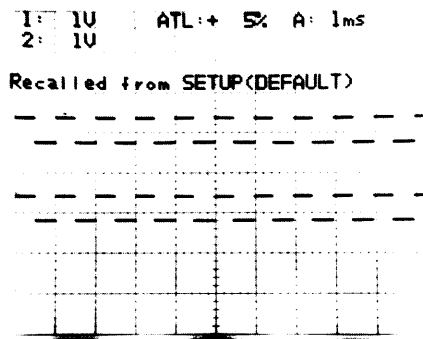

### 3-7-3 WAVEFORM RECALL/SAVE

#### MENU

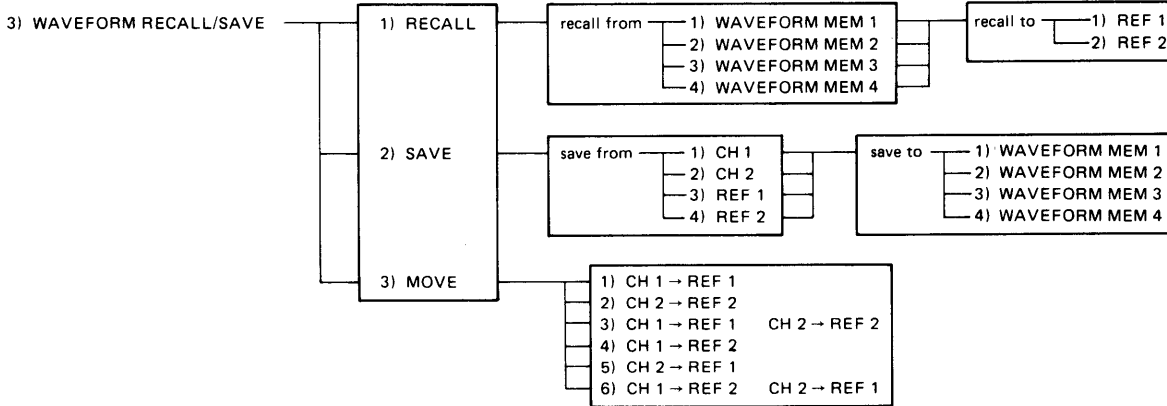

Used for saving in memory the waveforms which are to be stored, the standard one, or to be used for later comparison.

The power for the memory is backed up by a battery.

Described below is a measurement example which under CAL input, a signal from CH 1 is saved in memory 1 and a signal from CH 2 in memory 2, and recalled to REF 1 and REF 2 respectively.

#### 3-7-3-1 SAVE

##### Procedure I (CH 1 signal to memory 1)

————— "STORAGE" and "V. MODE" Setting —————

- ① Set **STORAGE** to ON.
- ② Set V. **MODE** to CH 1 CH 2 & REF.

————— "SETUP State" Setting —————

- ③ Display the waveform to be saved on the CRT.  
Setting example:  
V. MODE            CH 1  
VOLTS/DIV        1 V  
A TIME/DIV       1 ms

————— "WAVEFORM RECALL/SAVE" Setting —————

- ④ Press **3** while GUIDE MENU is displayed, and the following is displayed.

```

1) RECALL
2) SAVE
3) MOVE

```

————— "SAVE" Setting —————

- ⑤ Press **2** (SAVE is selected), and the following is displayed.

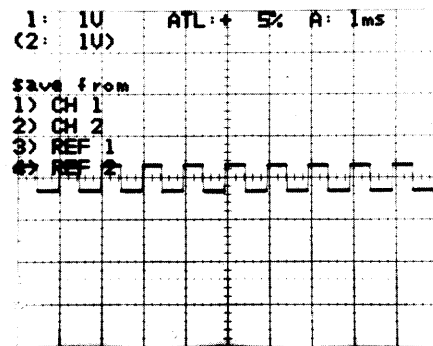

————— "Save from" Setting —————

- ⑥ Press **1** (CH 1 is selected), and the following is displayed.

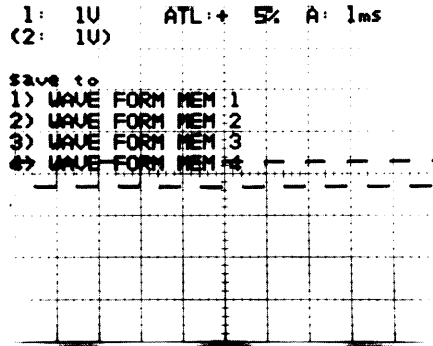

————— "Save to" Setting —————

- ⑦ Press **1** (WAVEFORM MEM 1 is selected), and the following is displayed (this waveform is saved in the Memory 1).

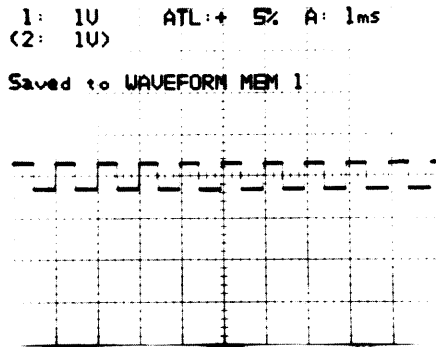

**Procedure II (CH2 signal to memory 2)**

- ③' Display the waveform to be saved next on the CRT.

Setting example:

```

V. MODE CH 2
VOLTS/DIV 0.5 V
A TIME/DIV 2 ms

```

- ④' Repeat operation ④ above.  
 ⑤' Repeat operation ⑤ above.

- ⑥' Press **2** (CH 2 is selected), and the following is displayed.

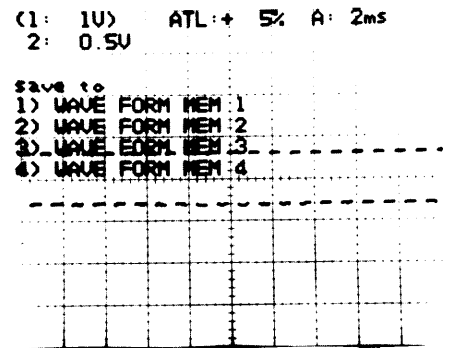

- ⑦' Press **2** (CH 2 is selected), and the following is displayed (this waveform is saved in the Memory 2).

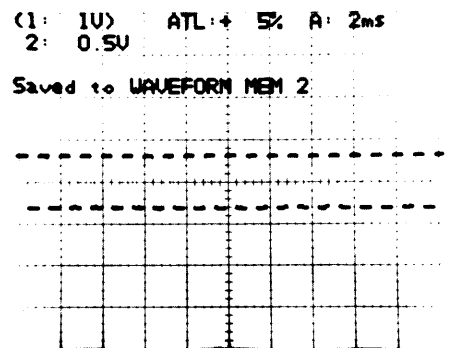

Other waveforms can be saved in this way.

### 3-7-3-2 RECALL

#### Procedure I (Memory 1 to REF 1)

—————"STORAGE" and "V. MODE" Setting ————

- ① Set **STORAGE** to ON.
- ② Set V. **MODE** to CH 1 CH 2 & REF.

—————"WAVEFORM RECALL/SAVE" Setting ————

- ③ Press **3** while GUIDE MENU is displayed, and the following is displayed.

```

1) RECALL
2) SAVE
3) MOVE

```

—————"RECALL" Setting ————

- ④ Press **1**, and the following is displayed.

```

recall from
1) WAVE FORM MEM 1
2) WAVE FORM MEM 2
3) WAVE FORM MEM 3
4) WAVE FORM MEM 4

```

—————"recall from" Setting ————

- ⑤ Press **1** again, and the following is displayed.

```

recall to
1) REF 1
2) REF 2

```

—————"recall to" Setting ————

- ⑥ Press **1** again, and the following figure is displayed, recalling the waveform saved by operations ③ to ⑧ described in the section 3-7-3-1 SAVE.

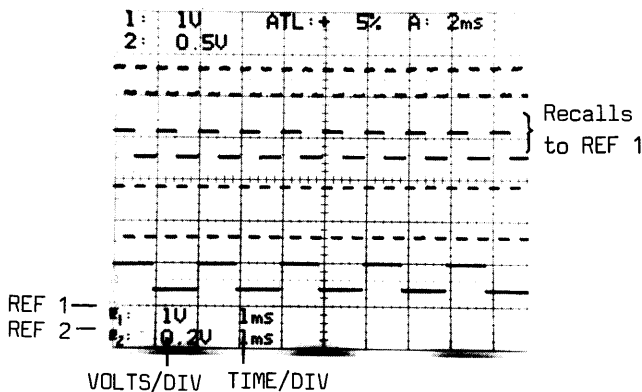

#### Procedure II (Memory 2 to REF 2)

Operate as described in operations ③ to ⑤.

- ⑥' Press **2**, and the following figure is displayed, recalling the waveform saved by operations ③ to ⑦ described in the section 3-7-3-1 SAVE.

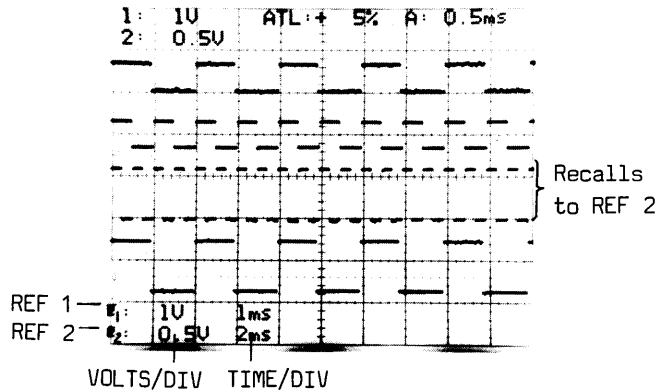

#### REF 1 and REF 2 Adjustment

Setting **2nd FUNC** to ON, vert position and deflection factor of REF 1 and REF 2 can be adjusted

with **POSITION** and **VOLTS/DIV**.

**Observation of Four Phenomena by Using WAVE-FORM MEMORY**

Set **STORAGE** to ON and V. **MODE** set to REF, and simultaneous observation of two saved waveforms and two unsaved waveforms are possible. Respective flowcharts are shown below.

a. Display the recalled waveforms to REF 1 and REF 2

b. Display the waveforms of CH 1 and CH 2 without saving them

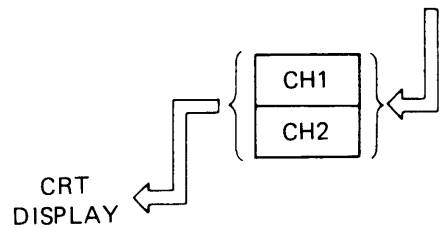
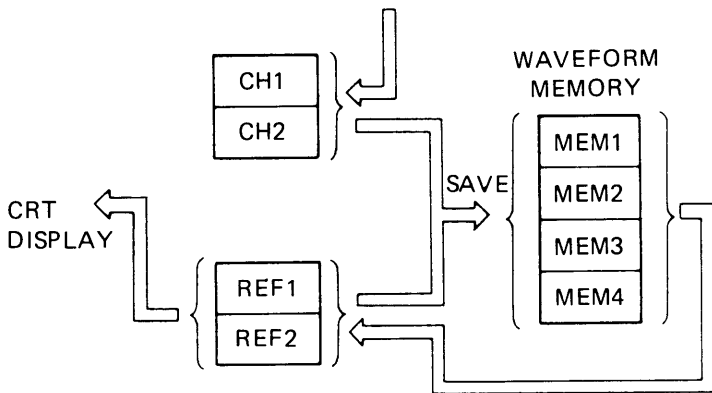

**Measurement Example**

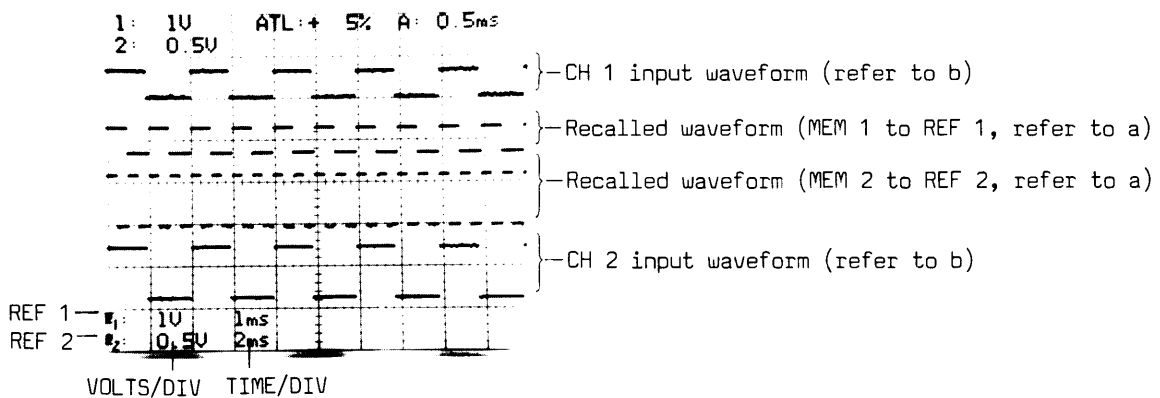



### 3-7-3-3 MOVE

#### Procedure (CH1 → REF 1, CH1 → REF 2)

- ① Set **STORAGE** to ON.
- ② Set V. **MODE** to CH 1 CH 2 & REF.

#### "WAVEFORM RECALL/SAVE" Setting

- ③ Press **3** while GUIDE MENU is displayed, while and the following is displayed.

```

1) RECALL
2) SAVE
3) MOVE

```

#### "MOVE" Setting

- ④ Press **3**, and the following is displayed.

```

1) CH1→REF1
2) CH2→REF2
3) CH1→REF1 CH2→REF2

4) CH1→REF2
5) CH2→REF1
6) CH1→REF2 CH2→REF1

```

#### "MOVE content" Selecting

- ⑤ Press **3** (select CH 1 → REF 1, CH 2 → REF 2), and the following is displayed.

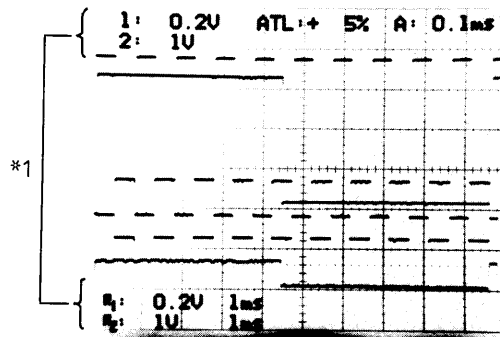

Indicates that the waveforms are moved from CH 1 display to REF 1 display and CH 2 to REF 2.

#### REF 1 and REF 2 Adjustment

Setting **2nd FUNC** to ON, vert position and deflection factor of REF 1 and REF 2 can be adjusted

with **POSITION** and **VOLTS/DIV**.

**Observation of Four Phenomena without Using WAVEFORM MEMORY**

When **STORAGE** is set at ON and V. **MODE** set at REF, simultaneous observation of two moved waveforms and the unmoved waveforms is possible.

a. Display the moved waveforms to REF 1 and REF 2

b. Display the unmoved waveforms to CH 1 and CH 2

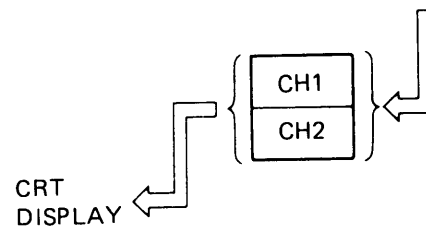
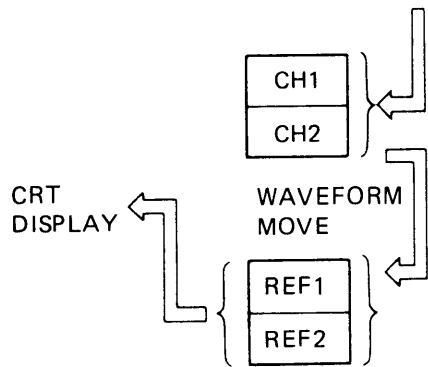

**Measurement Example**

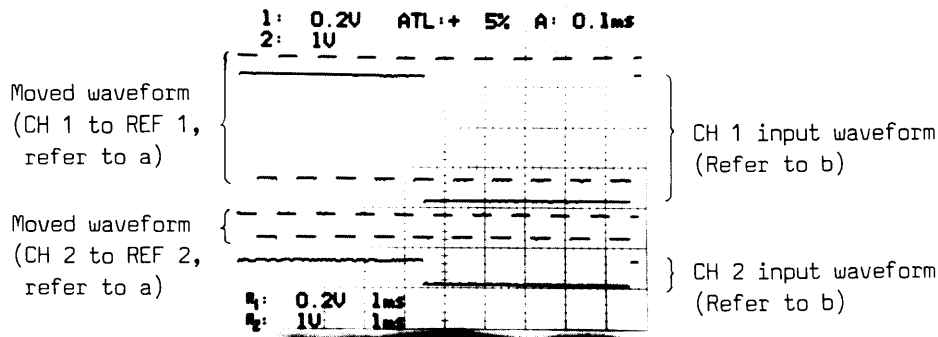

### 3-7-4 AVERAGING

#### MENU

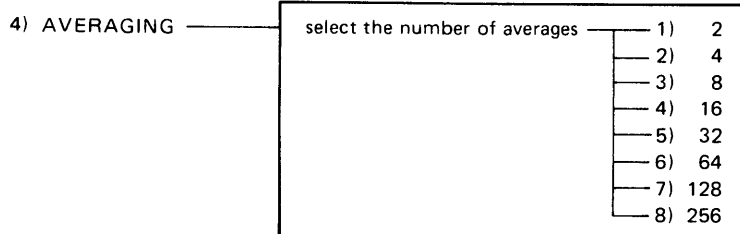

Used for extracting signals with regularity observed in noises. (A trigger signal triggered with that signal is necessary.)

#### Procedure

- ① Set **STORAGE** to ON.
- ② Press **4** while GUIDE MENU is displayed, and the following is displayed.

```

select the number of averages
1) 2
2) 4
3) 8
4) 16
5) 32
6) 64
7) 128
8) 256

```

- ③ Press **8** (256 is selected).
- ④ Press **FREEZE** (select OFF), and averaging is started.

#### Reference

Press **FREEZE** if averaging is to be interrupted. On the CRT, the waveform averaged at  $2^n$ th measurements immediately before interruption. Press **FREEZE** again, and averaging is resumed.

#### Averaging Methode

The rate of noise component elimination is proportional to the square root of N, the number of measurements used for the AVERAGING.

For example, when AVERAGING is performed after 32 measurements, noise is reduced to 1/5.6 (15 dB).

Averaging is done at every  $2^n$  measurements.

For example, if n is set at 5, data is rewritten at every 2, 4, 8, 16 and 32 measurements. When measurement by cursors is done at the same time, rewriting of the cursor is done at every  $2^n$  measurement.

Described below is a measurement example when under sine wave input.

1) Before Averaging

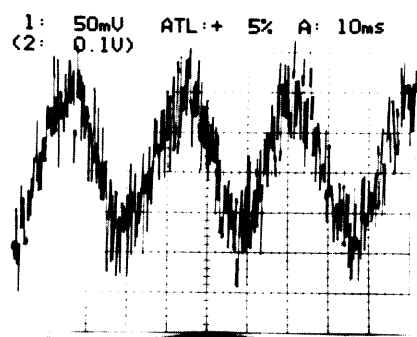

2) After Averaging

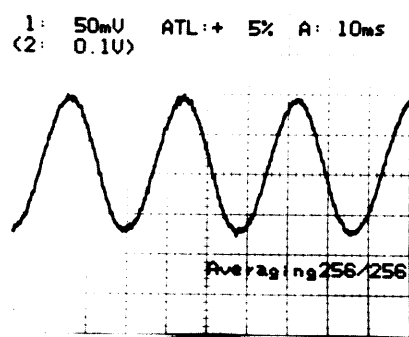

### 3-7-5 EQU-SAMPLING

Used when rapid repetitive signals are to be observed. Of two methods for equivalent sampling, random sampling and sequential sampling, the latter is employed in the DS-6121.

In the case of repeated waveforms, those with frequency up to 100 MHz can be stored. This is effective at rate faster than 2  $\mu$ s/DIV in the case of CH 1, and faster than 5  $\mu$ s/DIV in the case of CH 2.

Described below is a measurement example

#### Procedure

- ① Set STORAGE to ON.
- ② Press 5 while GUIDE MENU is displayed, and Equ-sampling is performed.

#### 1) Before Equ-sampling

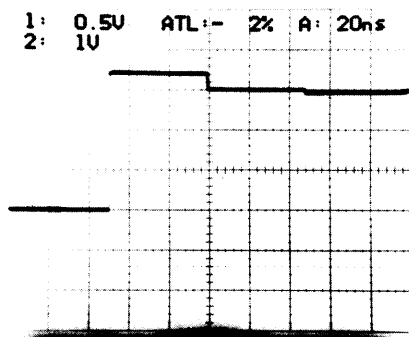

#### 2) After Equ-sampling

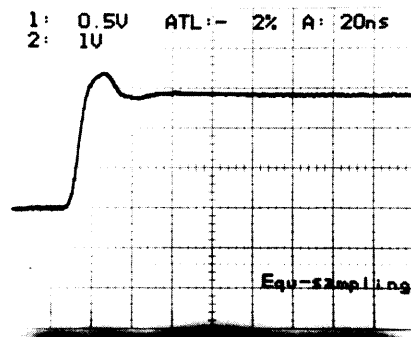

#### Caution

*A normal waveform is not displayed unless trigger is appropriately applied.*

*When using this FUNCTION at high sensitivity (1 – 5 mV/DIV), special attention should be paid. When the trigger cannot be applied appropriately, set TRIGGER COUPLING at HF REF.*

### 3-7-6 CURVE INTERPOLATION

Used to enhance the frequency characteristics further when the data quantity is reduced because the sweep time is in a rapid range, or the waveform was magnified.

This is effective only when the number of effective data on the CRT is 1/10.

Described below is a measurement example.

#### Procedure

- ① Set **STORAGE** to ON.
- ② Press **6** while GUIDE MENU is displayed, curve interpolation is performed.

When "WORKING" is displayed, it is in operation, and after interpolation is completed, "INTPLTING" is displayed. This is repeated. If interim observation is desired, press **FREEZE** key.

1) Before Curve Interpolation

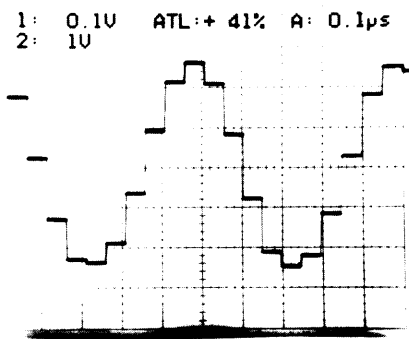

2) After Curve Interpolation

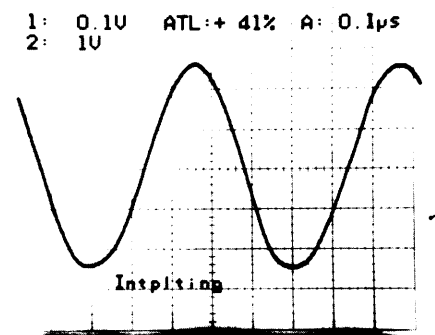

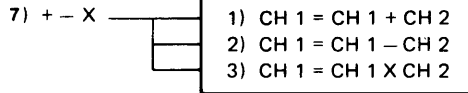
**3-7-7 + - X****MENU**

Displays a result of calculation between CH 1 input and CH 2 input in CH 1 display.

The following three calculations can be done.

CH 1 (Display) = CH 1 (Input) + CH 2 (Input)

CH 1 (Display) = CH 1 (Input) - CH 2 (Input)

CH 1 (Display) = CH 1 (Input) X CH 2 (Input)

In multiplying, the center on the CRT is defined as zero, and

(+1 DIV) X (+1 DIV) = +1 DIV

(+1 DIV) X (-1 DIV) = -1 DIV

Particularly, the multiplication mode is useful, for example, when an instantaneous power waveform is to be observed.

Example of calculation when CH 1 input is set at about 1.5 DIV above from the center, CH 2 input at about 1 DIV below (V COUPL is set to DC for both CH 1 and CH 2).

**Procedure**

- ① Set **STORAGE** to ON.
- ② Press **7** while GUIDE MENU is displayed, and the following is displayed.  
CH 1 about +1.5 DIV  
CH 2 about -1.0 DIV

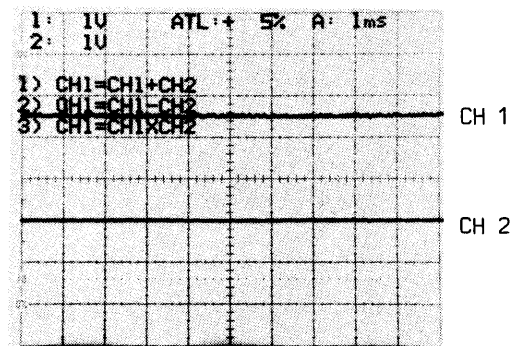

- ③ Press **1**, and addition is performed.
- Press **2**, and subtraction is performed.
- Press **3**, and multiplication is performed.

**Addition**

Press **1**, the following is displayed.

$$\text{CH 1 (Display)} = \text{CH 1 (+1.5)} + \text{CH 2 (-1)}$$

$$= 0.5 \text{ DIV}$$

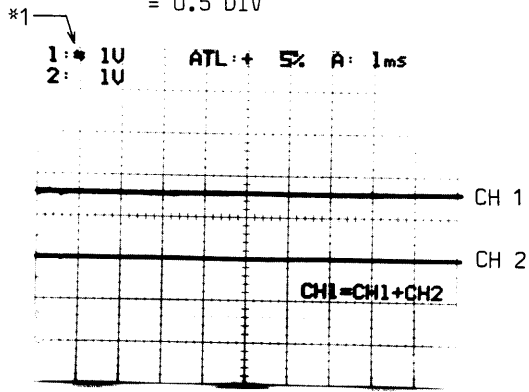

**\* Display (\*1)**

This shows that the calculation is conducted by the data displayed on the CRT (in divisions) irrelevant of the deflection factor. Therefore, CH 1 deflection factor display is ineffective and an inequality " " is displayed. Results of calculation are displayed on CH 1.

**Subtraction**

Press **2**, the following is displayed.

$$\text{CH 1 (Display)} = \text{CH 1 (+1.5)} - \text{CH 2 (-1)}$$

$$= 2.5 \text{ DIV}$$

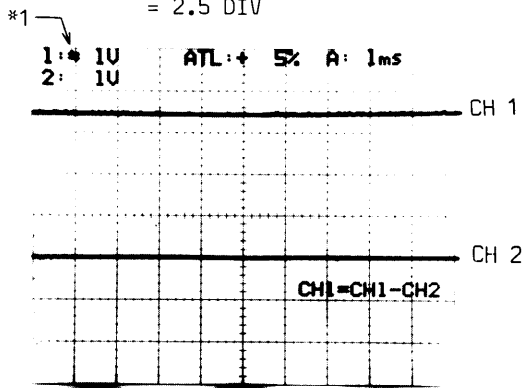

**Multiplication**

Press **3**, the following is displayed.

$$\text{CH 1 (Display)} = \text{CH 1 (+1.5)} \times \text{CH 2 (-1)}$$

$$= 1.5 \text{ DIV}$$

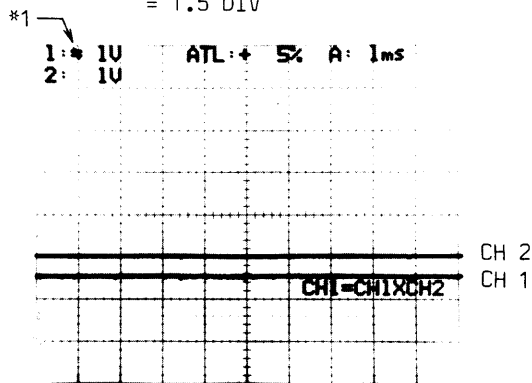



### 3-7-8 GO/NO GO

#### MENU

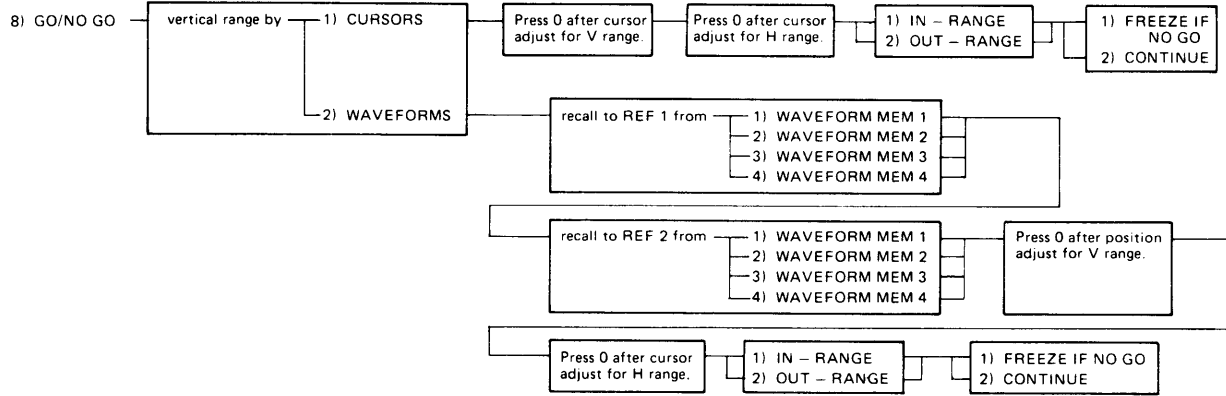

Used for determining whether the observed waveform is within the specified range or not.

Useful in automatic control or automatic judgement.

The judgement is done by indicating IN-RANGE or OUT-RANGE.

#### Method 2

|                 |                   |       |
|-----------------|-------------------|-------|
| Horizontal axis | Cursor 1          | Left  |
|                 | Cursor 2          | Right |
| Vertical axis   | Cursor 1 or REF 1 | Upper |
|                 | Cursor 2 or REF 2 | Lower |

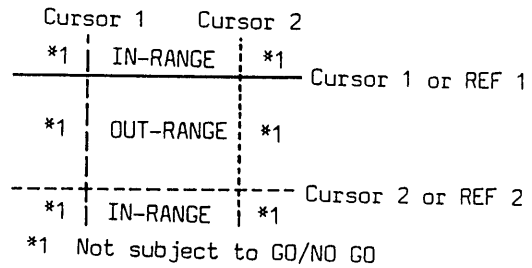

#### Setting of Measuring Range

##### a) CURSORS

Both vertical and horizontal axes are to be set by cursors.

##### b) WAVEFORMS

The vertical axis is set by two waveforms recalled from REF 1 and REF 2, and the horizontal axis by the cursor.

#### Method 3

|                 |                   |       |
|-----------------|-------------------|-------|
| Horizontal axis | Cursor 1          | Right |
|                 | Cursor 2          | Left  |
| Vertical axis   | Cursor 1 or REF 1 | Lower |
|                 | Cursor 2 or REF 2 | Upper |

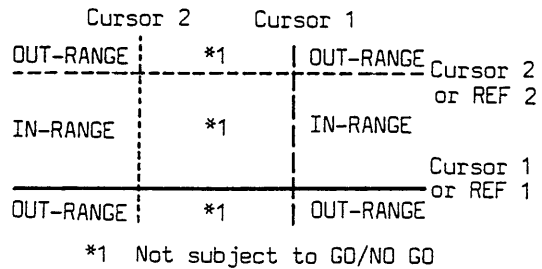

#### Setting of IN-RANGE and OUT-RANGE

The following four methods are provided for setting IN-RANGE or OUT-RANGE.

#### Method 1

|                 |                   |       |
|-----------------|-------------------|-------|
| Horizontal axis | Cursor 1          | Left  |
|                 | Cursor 2          | Right |
| Vertical axis   | Cursor 1 or REF 1 | Lower |
|                 | Cursor 2 or REF 2 | Upper |

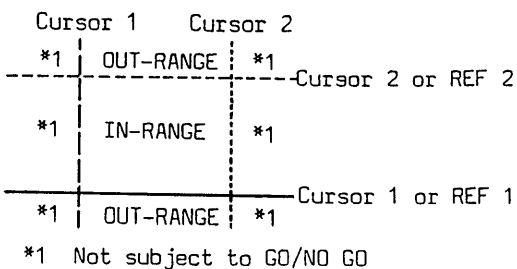

**Method 4**

|                 |                   |       |
|-----------------|-------------------|-------|
| Horizontal axis | Cursor 1          | Right |
|                 | Cursor 2          | Left  |
| Vertical axis   | Cursor 1 or REF 1 | Upper |
|                 | Cursor 2 or REF 2 | Lower |

|           |          |    |           |                   |
|-----------|----------|----|-----------|-------------------|
|           | Cursor 2 | *1 | Cursor 1  |                   |
| IN-RANGE  |          |    | IN-RANGE  | Cursor 1 or REF 1 |
| OUT-RANGE |          |    | OUT-RANGE |                   |
| IN-RANGE  |          |    | IN-RANGE  | Cursor 2 or REF 2 |

\*1 Not subject to GO/NO GO

**GO/NO GO Setting**

**IN-RANGE:**

When waveform is within "IN-RANGE"  
IN-RANGE GO

When waveform is without "IN-RANGE"  
IN-RANGE NO GO

**OUT-RANGE:**

When waveform is within "OUT-RANGE"  
OUT-RANGE GO

When waveform is without "OUT-RANGE"  
OUT-RANGE NO GO

**Measurement Example**

**1) Overshoot Judgement**

Assumed specifications: Overshoot 3% or less  
The vertical cursor 2 is adjusted to the position of 3% level.

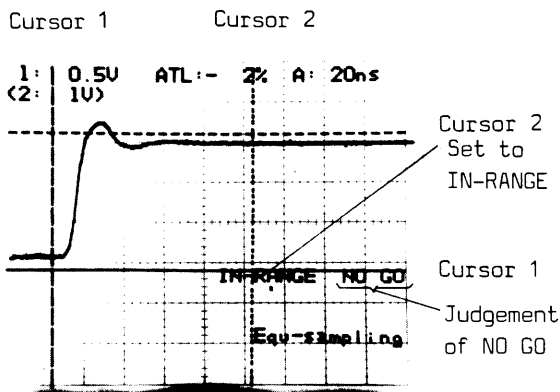

The figure above shows judgement of NO GO since the overshoot of input waveform is over 30%.

**2) Detection of Abnormal Signals**

Assumed specifications: No glitches at the lower level part of the pulse waveform.

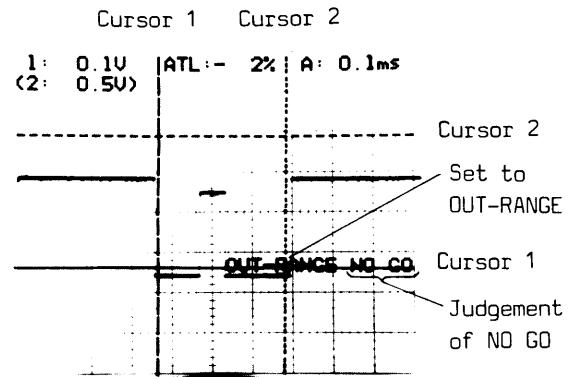

The figure above shows judgement of NO GO since there is a glitch.

**3) Waveform Judgement**

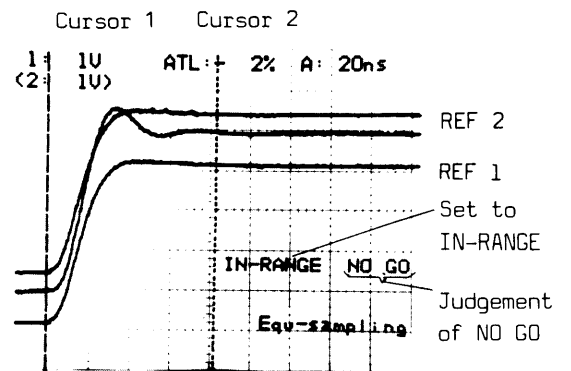

The figure above shows judgement of NO GO since the waveform is out of the range set by REF 1 and REF 2.

3-7-8-1 CURSORS

Described below is the measurement example when the following setting is made under CAL input.

V. MODE CH 1  
 VOLTS/DIV 1 V  
 A TIME/DIV 0.5 ms

Procedure

————— "STORAGE" Setting —————

- ① Set **STORAGE** to ON.

————— "GO/NO GO" Setting —————

- ② Press **8** while GUIDE MENU is displayed, and the following is displayed.

vertical range by  
 1) CURSORS  
 2) WAVEFORMS

————— "CURSORS" Setting —————

- ③ Press **1**, and the following is displayed.

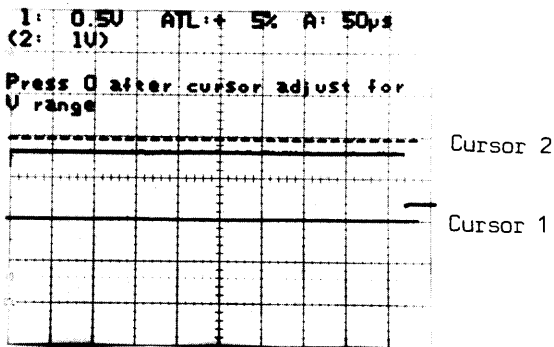

————— "V. Cursors" Adjustment —————

- ④ Adjust the vertical positions of the cursors with **CURSOR 1** and **CURSOR 2** keys.

- ⑤ Press **0**, and the following is displayed.

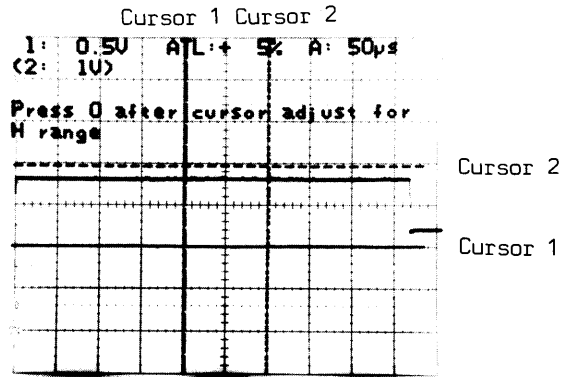

————— "H. Cursors" Adjustment —————

- ⑥ Adjust the horizontal positions of cursors with **CURSOR 1** and **CURSOR 2** keys.
- ⑦ Press **0**, and the following is displayed.

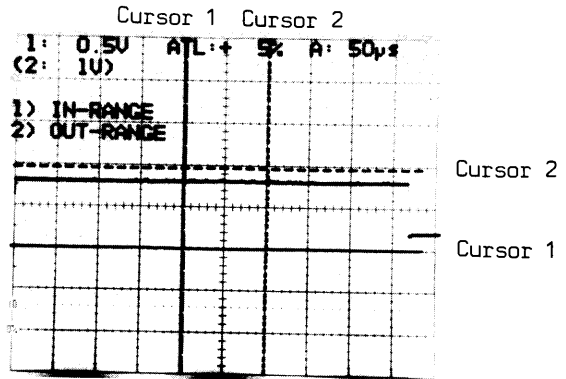

————— "IN-RANGE or OUT-RANGE" Selecting —————

- 1) IN-RANGE is subject to NO GO operation.
- 2) OUT-RANGE is subject to NO GO operation.

- ⑧ Press **1** (IN-RANGE GO is selected), and the following is displayed.

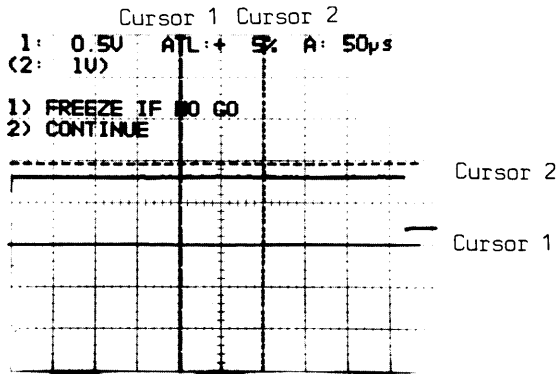

- 1) FREEZE IF NO GO  
 When the range is outside of two cursors (NO GO), FREEZE is effectuated.
- 2) CONTINUE  
 Even when the range is outside of two cursors (NO GO), FREEZE is not effectuated.

———— "FREEZE or CONTINUE" Selecting ————

- ⑨ Press **1** (FREEZE IF NO GO is selected), and the following is displayed.  
 The waveform is within two cursors, and "IN RANGE GO" is displayed.

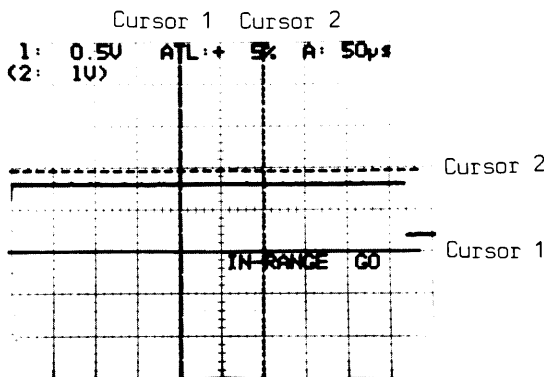

When the input signal is as shown in the following, the range is outside of the two cursors, and "IN-RANGE NO GO" is displayed. As FREEZE IF NO GO was selected in the operation ⑧ the waveform is frozen.

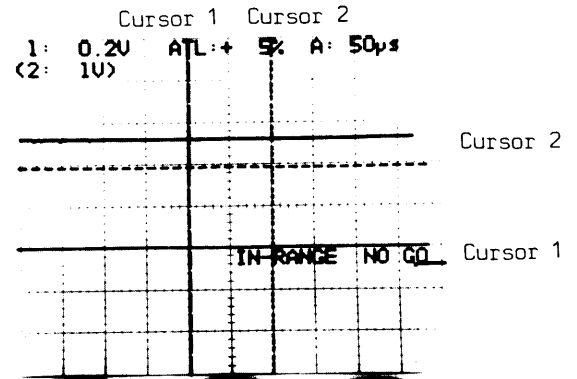

### 3-7-8-2 WAVEFORMS

Described below is the measurement example when the following setting is made.

V. MODE CH 1  
 VOLTS/DIV 1 V  
 A TIME/DIV 0.5 ms

#### Procedure

##### "STORAGE and V. MODE" Setting

- ① Set **STORAGE** to ON.
- ② Set V. **MODE** to CH 1 CH 2 & REF.

##### "GO/NO GO" Setting

- ③ Press **8** while GUIDE MENU is displayed, and the following is displayed.

```
vertical range by
1) CURSORS
2) WAVEFORMS
```

##### "WAVEFORMS" Setting

- ④ Press **2** (WAVEFORM), and the following is displayed.

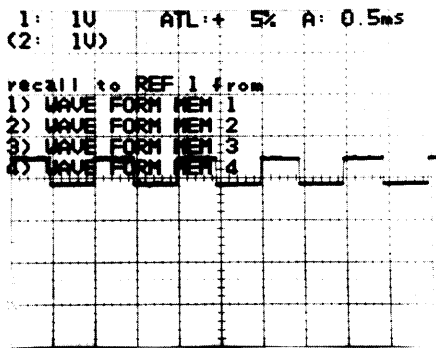

##### "recall to REF 1 from" Selecting

The number of the memory to be recalled to REF 1 is selected from 1) to 4).

- ⑤ Press **1** (WAVEFORM MEM 1), and the following is displayed.

```
1: 1V ATL:+ 5% A: 0.5ms
(2: 1V)
```

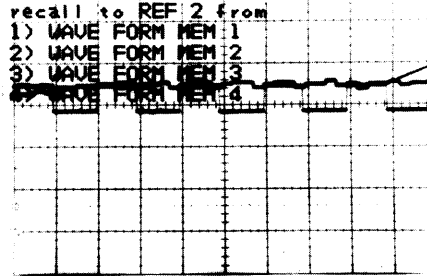

The waveform saved in REF 1

##### "recall to REF 2 from" Selecting

The number of the memory to be recalled to REF 2 is selected from 1) to 4).

- ⑥ Press **2** (WAVEFORM MEM 2), and the following is displayed.

```
1: 1V ATL:+ 5% A: 0.5ms
(2: 1V)
```

Press 0 after position adjust for V range

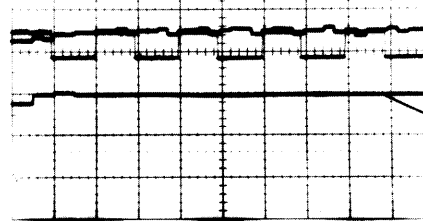

The waveform waved in REF 2

##### "REF 1, 2 V. Position" Adjustment

- ⑦ Set **2nd FUNC** to ON.
- ⑧ Adjust the vertical position of cursors using



```
1: 1V ATL:+ 5% A: 0.5ms
(2: 1V)
```

Press 0 after position adjust for V range

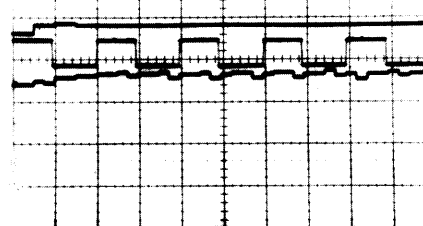

REF 2  
 REF 1

⑨ Press **0**, and the following is displayed.

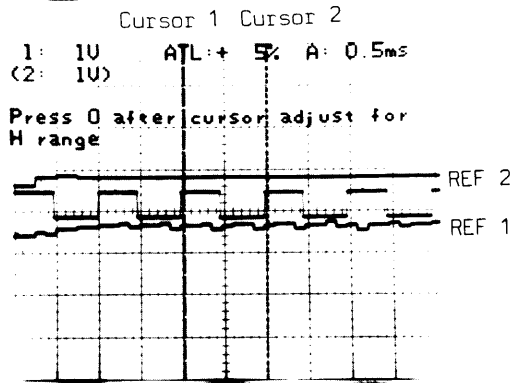

————— "H. Cursors" Adjustment —————

⑩ Adjust the horizontal positions of cursors

with **CURSOR 1** and **CURSOR 2**.

⑪ Press **0**, and the following is displayed.

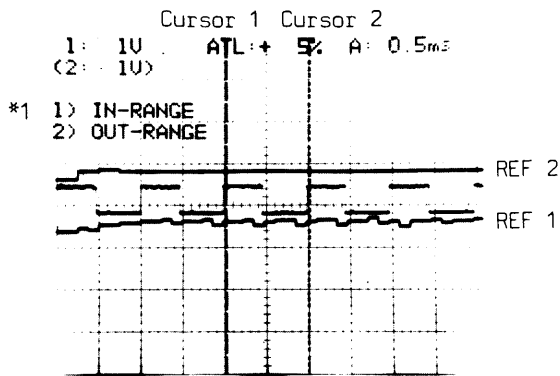

————— "IN-RANGE or OUT-RANGE" Selecting —————

- 1) IN-RANGE is subject to GO operation.  
2) OUT-RANGE is subject to GO operation.

⑫ Press **1** (IN-RANGE is selected), and the following is displayed.

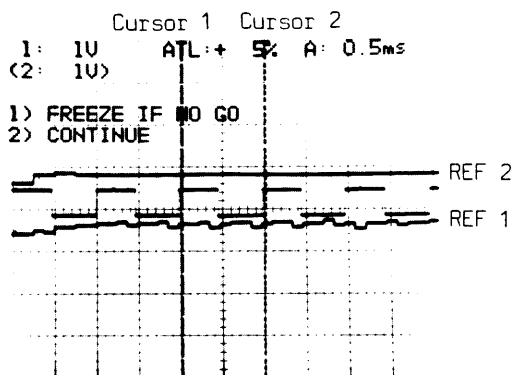

————— "FREEZE or CONTINUE" Selecting —————

- 1) FREEZE IF NO GO  
When NO GO, FREEZE is effectuated.  
2) CONTINUE  
Even when NO GO, FREEZE is effectuated.

⑬ Press **1** (FREEZE IF NO GO is selected),

the following is displayed.  
As the waveform is within the two cursors, the state is "IN-RANGE GO".

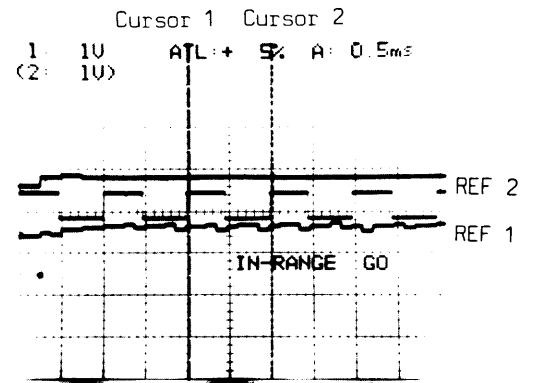

When the waveform is in a position as shown in the following figure, it is outside of the two cursors and the state is "IN-RANGE NO GO". As FREEZE IF NO GO was selected, the waveform is frozen.

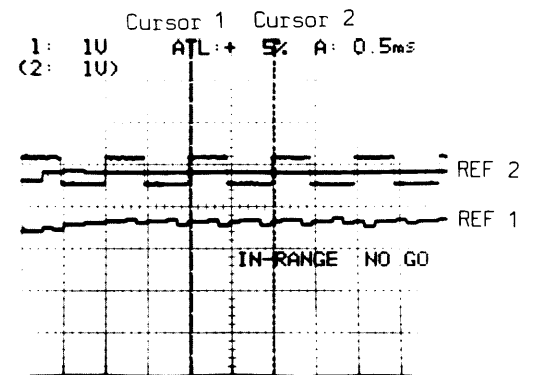

\*1

- 1) IN-RANGE  
The range between two cursors is subject to NO GO operation.
- 2) OUT-RANGE  
The range outside of two cursors is subject to NO GO operation.

## 3-7-9 WAVEFORM OUT

## MENU

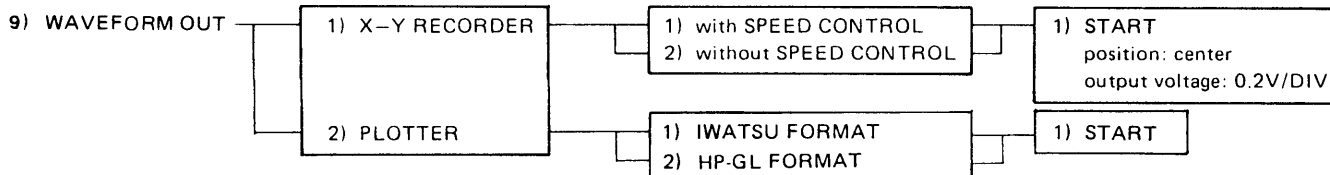

Using an X-Y recorder or a plotter (SR-6602, SR-6620, or SR-6625 of IWATSU format and SR-6620H, HP-7440A, HP-7470A, HP-7475A of HP-GL format), hard-copies of waveforms on the CRT can directly be obtained.

## Output Operations on X-Y recorder

————— Settings on the Rear Panel —————

- ① Turn STORAGE/REAL on switch on the rear panel to STORAGE.

————— Connection to the X-Y recorder —————

- ② Connect X OUT, Y OUT, and PEN UP on the rear panel of the DS-6121 to X INPUT, Y INPUT, and PEN UP INPUT of the X-Y recorder with cables, respectively.

————— Settings on the X-Y Recorder —————

- ③ Adjust the deflection factor and pen position of the X-Y recorder.  
Deflection factor: Both X and Y outputs of DS-6121 are in the unit of 0.2 V per one DIV on the CRT.  
Pen position: This is because both X and Y outputs of DS-6121 are zero volt, which corresponds to the center of the CRT, until the recorder is started by pressing **1** key.

————— Settings on the Front Panel —————

- ④ Press **9** on the GUIDE MENU and the following is displayed.

**1) X-Y RECORDER**  
**2) PLOTTER**

- ⑤ Press **1** and the following is displayed.

**1) with SPEED CONTROL**  
**2) without SPEED CONTROL**

- 1) with SPEED CONTROL

When the waveforms greatly change, the output is given with slow speed.

When changing small, the output is given with high speed.

- 2) without SPEED CONTROL

Whether the waveforms change small or greatly, the output is given with constant speed.

- ⑥ Select the pen speed. Press **1** or **2** and the following is displayed.

**1) START**

POSITION: Center

Output voltage: 0.1 V/DIV

- ⑦ Press **1** and the recorder is started.

## Output Operations on the Plotter

### Interface unit setting

- ① When GP-IB is to be used, set any one of INSTRUMENT ADDRESS switches 1 to 5 to "1" side. Refer to 4-2 ADDRESSING (page 4-4).
- When RS-232-C is to be used, refer to 5-2 SETTING OF SWITCHES (page 5-8).

### Attachment of Package

- ② Insert GP-IB or RS-232-C package to the hole on the rear panel, and connect it to the plotter with a relevant cable.

### Settings on the Plotter

- ③ When the SR-6620 model is to be used, set the stepsize at 0.1 mm.
- ④ Adjust the plotter pen position.

### Settings on the Front Panel

- ⑤ Press **9** on the GUIDE MENU and the following is displayed.
  - 1) X-Y RECORDER
  - 2) PLOTTER
- ⑥ Press **2** and the following is displayed.
  - 1) IWATSU FORMAT
  - 2) HP-GL FORMAT
- ⑦ In case of using IWATSU format, press **1**.  
 In case of using HP-GL format, press **2**.  
 and **1) START** is displayed.
- ⑧ Press **1** and the plotter is started.

## Setting of HORIZONTAL POSITION

Though the horizontal position of waveform on CRT will be moved by **POSITION** and **FINE**, the horizontal position of waveform plotted in an X-Y recorder or a plotter will not move. Therefore, the waveforms on CRT and that plotted on an X-Y recorder or a plotter may differ in horizontal position.

To move the horizontal position plotted on an X-Y recorder or a plotter, set **HORIZ DISPLAY** to A, move it by CH 1 POSITION and change to X-Y mode.

## On the Range of Plot

In an X-Y recorder and a plotter, the plot will go beyond the right-end scale by 12 data as shown in the figure below.

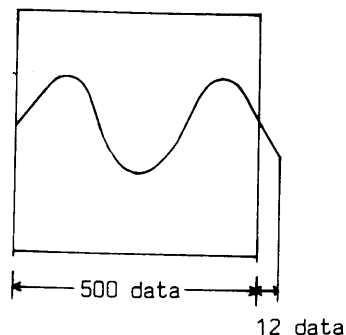

## CAUTION

*When being a difference of position between X-Y recorder/plotter drawing and CRT display, adjust the cursor position in accordance with "3-8 Adjustment of real/storage waveform cursor position".*



**Plotter setting**

**IWATSU FORMAT**

Set the plotter's SW1 and SW2 as shown in Figure below.

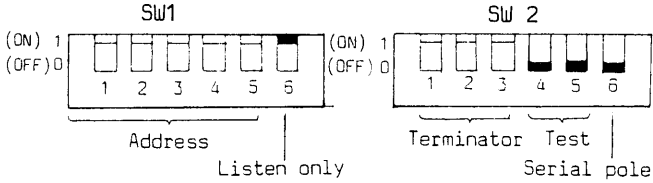

- Address (SW1 to 5): Option
- Listen only (SW1 6): ON
- Terminator (SW2 1 to 3): Same as delimiter of DS-6121
- Test (SW2 4 and 5): OFF
- Serial pole (SW2 6): OFF

**Connection to SR-6620 or SR-6625**

When used with SR-6620 or set the stepsize changeover pin inside the plotter to 0.1 mm (see the next page). Otherwise, a square frame will be drawn as shown below.

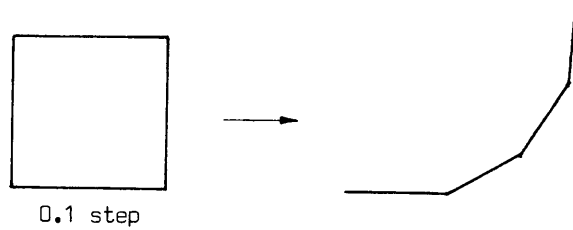

**On the Character Display of Plotter**

Some characters plotted by a plotter may differ from those on CRT.

| On CRT | On Plotter |
|--------|------------|
| ↖      | !          |
| ↓      | -          |

• In HP-GL format, "u" is output as "u".

**If a wrong format is selected with a guide menu:**

- a. For GP-IB
  - An error will be indicated on the plotter when connecting the plotter of HP-GL format, selecting the IWATSU format in step ⑦ and pressing 1 (to start the plotter) in step ⑧ or vice versa. In this case, the instrument provides the data to the plotter, but the plotter does not output them. On completion of transferring all the data, the instrument will return to the previous condition.

Press **QUIT LOCAL** key to interrupt transfer.

- b. For RS-232-C
  - Press **QUIT LOCAL** key twice to reset when connecting the plotter of HP-GL format, selecting the IWATSU format in step ⑦ and pressing 1 (to start the plotter) in step 8 .
  - Press **QUIT LOCAL** key once to reset when connecting the plotter of IWATSU format, selecting the HP-GL format in step ⑦ and pressing 1 (to start the plotter) in step ⑧ .

**Caution on SR-6602**

*Each time the SR-6602 plotter is used with the DS-6121, you must manually initialize operation as follows:*

**Procedure**

1. Press **QUIT LOCAL** key, the plotter pen is set to HOME POSITION.
2. Turn the SR-6602's POWER switch off.
3. Set the pen position to initial setting position (Refer to the SR-6602's instruction manual.)
4. Turn the SR-6602's POWER switch on.

**HP-GL FORMAT**

Set to the plotter as follows.

1. Set the paper size to "A4".
2. For GP-IB interface: Set to listen only.
3. For RS-232-C interface: Set the baud rate and the parity to the same as for DS-6121.

**Example for Construction (I) Plotter**

IWATSU FORMAT

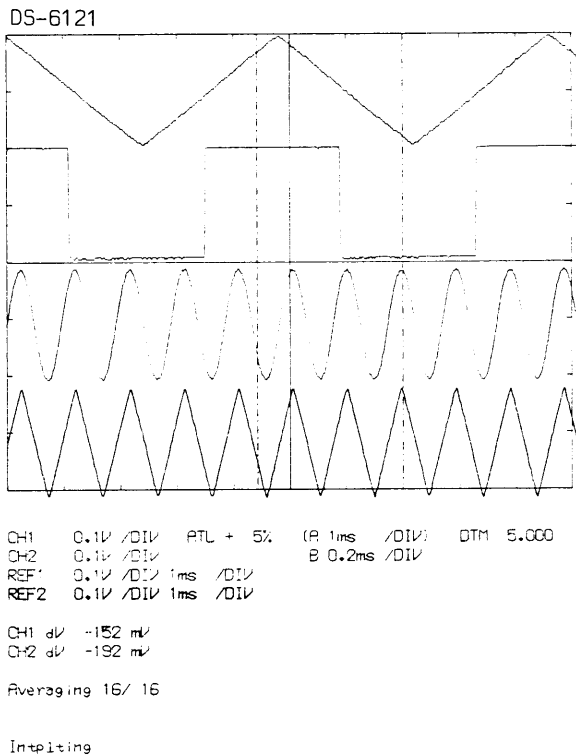

HP-CL FORMAT

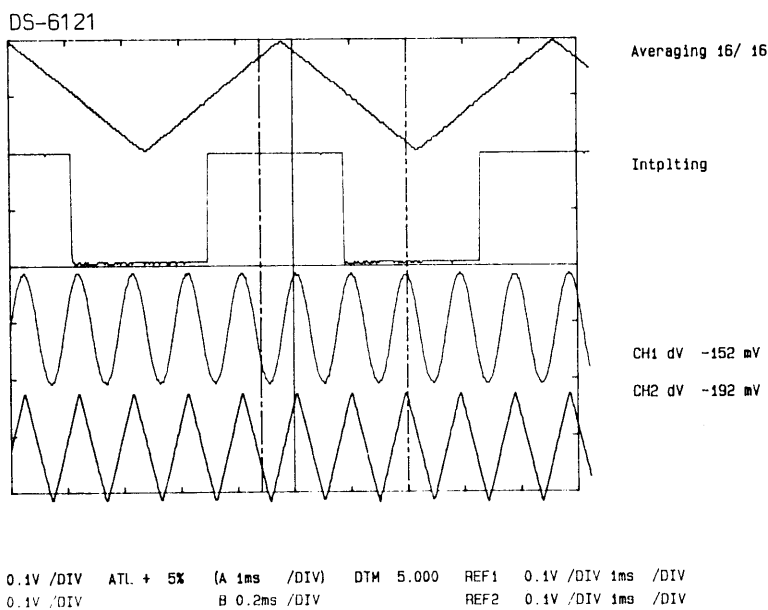

**Example for Construction (II) X-Y recorder**

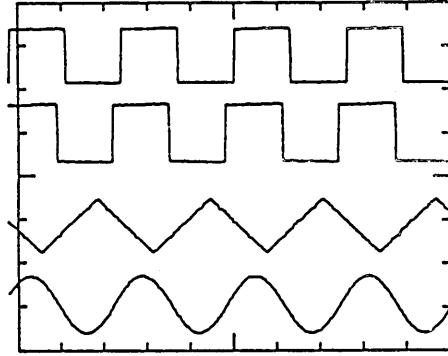

# DS-6121A

### 3-7 GUIDE MENU

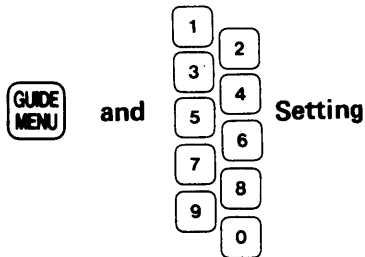

When **GUIDE MENU** is pressed, GUIDE MENU as shown in the following display appears on the screen. The number of FUNCTIONS to be used is selected from 1) to 0).

- 1) MEASUREMENT BY CURSORS
- 2) SETUP RECALL/SAVE
- 3) WAVEFORM RECALL/SAVE
- 4) AVERAGING
- 5) ENVELOPING (only CH1)
- 6) EQU-SAMPLING
- 7) CURVE INTERPOLATION
- 8) +-X
- 9) GO/NO GO
- 0) WAVEFORM OUT

- |                                                                                                                                                                                                                                                                                                                                                                                                                                                                                                                                                                                                                                                                                   |                                                                                                                                                                                                                                                                                                                                                                                                                                                                                                                                                                                                                                                                                                                                              |
|-----------------------------------------------------------------------------------------------------------------------------------------------------------------------------------------------------------------------------------------------------------------------------------------------------------------------------------------------------------------------------------------------------------------------------------------------------------------------------------------------------------------------------------------------------------------------------------------------------------------------------------------------------------------------------------|----------------------------------------------------------------------------------------------------------------------------------------------------------------------------------------------------------------------------------------------------------------------------------------------------------------------------------------------------------------------------------------------------------------------------------------------------------------------------------------------------------------------------------------------------------------------------------------------------------------------------------------------------------------------------------------------------------------------------------------------|
| <ol style="list-style-type: none"> <li>1) Measurement by Cursors<br/>Cursor measurement can be performed in either the real-time or the storage mode.</li> <li>2) Setup recall/save<br/>Used for saving and recalling setup (setting on the front panel). Up to four setups can be saved.</li> <li>3) Waveform recall/save<br/>Used for saving or recalling waveform data. Up to four waveforms can be saved; these waveforms can be compared.</li> <li>4) Averaging<br/>Eight setting levels are provided, enabling averaging from 2 up to 256 times.</li> <li>5) Enveloping<br/>Used for aliasing prevention, measurement of AM-modulated wave and glitch detection.</li> </ol> | <ol style="list-style-type: none"> <li>6) Equivalent sampling<br/>Continuous waveforms of up to 100 MHz can be sampled in order and digitized.</li> <li>7) Curve Interpolation<br/>This mode is for the interpolation of curves.</li> <li>8) + - x Calculation<br/>Addition, subtraction or multiplication can be performed in this mode.</li> <li>9) GO/NO GO Judgement<br/>Mainly used when judging whether a phenomenon is acceptable or not. The judgement range can be set by two methods, using cursors and waveforms.</li> <li>0) Waveform Output<br/>The on-screen data can be output to an X-Y recorder or plotter. The speed of the waveform output to the X-Y recorder can be controlled, and its scale can be output.</li> </ol> |
|-----------------------------------------------------------------------------------------------------------------------------------------------------------------------------------------------------------------------------------------------------------------------------------------------------------------------------------------------------------------------------------------------------------------------------------------------------------------------------------------------------------------------------------------------------------------------------------------------------------------------------------------------------------------------------------|----------------------------------------------------------------------------------------------------------------------------------------------------------------------------------------------------------------------------------------------------------------------------------------------------------------------------------------------------------------------------------------------------------------------------------------------------------------------------------------------------------------------------------------------------------------------------------------------------------------------------------------------------------------------------------------------------------------------------------------------|

And then select necessary key from 1) to 0) according to Guide Menu Free.

Guide Menu Tree

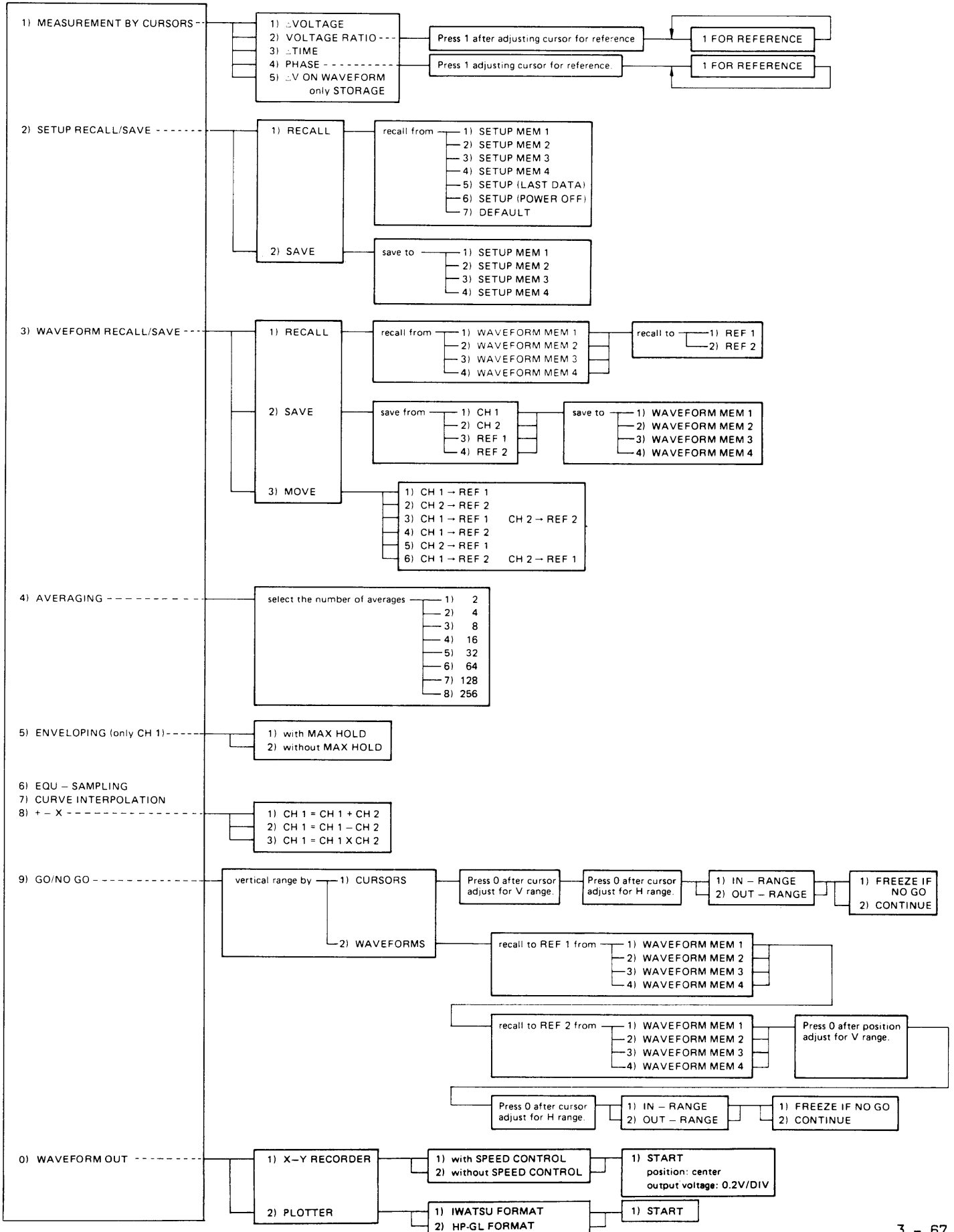

**Usage Range**

| MENU<br>NO. | STORAGE       |               |
|-------------|---------------|---------------|
|             | OFF (REAL)    | ON            |
| 1           | $\Delta^{*1}$ | ○             |
| 2           | ○             | ○             |
| 3           | ERR 7         | ○             |
| 4           | ERR 7         | ○             |
| 5           | ERR 7         | ○             |
| 6           | ERR 7         | $\Delta^{*2}$ |
| 7           | ERR 7         | ○             |
| 8           | ERR 7         | ○             |
| 9           | ERR 7         | ○             |
| 0           | ERR 7         | ○             |

*\*1 Except  $\Delta V$  ON WAVEFORM*

*\*2 Effectuated when TIME/DIV is set at faster than 2  $\mu s$ /DIV in the case of CH1 only, and faster than 5  $\mu s$ /DIV in the case of CH1 and CH2.*

**Error Messages**

When non-allowable setting from GUIDE MENU was selected, an error message appears on the screen.

| Error Number | Description                                                                                   |
|--------------|-----------------------------------------------------------------------------------------------|
| ERR 1        | Non-selectable FUNCTION was selected while performing measurement by cursors                  |
| ERR 2        | Non-selectable FUNCTION was selected while performing ENVELOPING                              |
| ERR 3        | Non-selectable FUNCTION was selected while performing EQU-SAMPLING                            |
| ERR 4        | Non-selectable FUNCTION was selected while performing curve interpolation                     |
| ERR 5        | Performing +, -, x                                                                            |
| ERR 6        | Performing GO/NO, GO                                                                          |
| ERR 7        | Non-selectable FUNCTION was selected which cannot be performed under present SETUP conditions |
| ERR 8        | Non-selectable FUNCTION was selected while performing AVERAGING                               |
| ERR 9        | Interface unit is not connected while performing PLOTTER OUTPUT                               |

**List of Functions Which can be Selected in Combination**

The following table shows whether or not a particular F1 MENU item can be selected simultaneously with a particular F2 item.

|    |                           | F2                        |                      |                         |              |               |                 |                        |          |             |                 |
|----|---------------------------|---------------------------|----------------------|-------------------------|--------------|---------------|-----------------|------------------------|----------|-------------|-----------------|
|    |                           | 1) MEASUREMENT BY CURSORS | 2) SETUP RECALL/SAVE | 3) WAVEFORM RECALL/SAVE | 4) AVERAGING | 5) ENVELOPING | 6) EQU-SAMPLING | 7) CURVE INTERPOLATION | 8) + - X | 9) GO/NO GO | 0) WAVEFORM OUT |
| F1 | 1) MEASUREMENT BY CURSORS |                           |                      |                         |              |               |                 |                        |          |             |                 |
|    | 2) SETUP RECALL/SAVE      |                           | ○                    |                         |              |               |                 |                        |          |             |                 |
|    | 3) WAVEFORM RECALL/SAVE   |                           |                      | ○                       |              |               |                 |                        |          |             |                 |
|    | 4) AVERAGING              |                           | ○                    | ○                       | ○            |               |                 |                        |          |             |                 |
|    | 5) ENVELOPING             |                           | ○                    | ○                       | ○            |               |                 |                        |          |             |                 |
|    | 6) EQU-SAMPLING           |                           | ○                    | ○                       | ○            | ○             |                 |                        |          |             |                 |
|    | 7) CURVE INTERPOLATION    |                           | ○                    | ○                       | ○            | ○             | ○               |                        |          |             |                 |
|    | 8) + - X                  |                           | ○                    | ○                       | ○            | ○             | ○               | ○                      |          |             |                 |
|    | 9) GO/NO GO               |                           |                      | ○                       | *1           | ○             | ○               | ○                      | ○        |             |                 |
|    | 0) WAVEFORM OUT           |                           |                      |                         |              |               |                 |                        |          |             |                 |

○ shows that the simultaneous selection is possible.

\*1 SAVE can be performed simultaneously but RECALL should be performed with other modes.

**Quit of Guide Menu**

-  key is used for clearing FUNCTION selected from GUIDE MENU.

Selecting multiple FUNCTIONS from GUIDE MENU and pressing  after completion of operating, all FUNCTIONS is cleared.

Selecting multiple FUNCTIONS from GUIDE MENU and pressing  during operating, only one FUNCTION selected last is cleared.
- Clearing a particular FUNCTION find its (OFF) display in GUIDE MENU and press the relevant numerical key with the corresponding function number.

- 1) MEASUREMENT BY CURSORS
- 2) SETUP RECALL/SAVE
- 3) WAVEFORM RECALL/SAVE
- 4) AVERAGING
- 5) ENVELOPING (only CH1)
- 6) EQU-SAMPLING
- 7) CURVE INTERPOLATION<OFF>
- 8) + - X
- 9) GO/NO GO
- 0) WAVEFORM OUT

When  is pressed, only 7) curve interpolation is cleared.



### 3-7-1 MEASUREMENT BY CURSORS

#### MENU

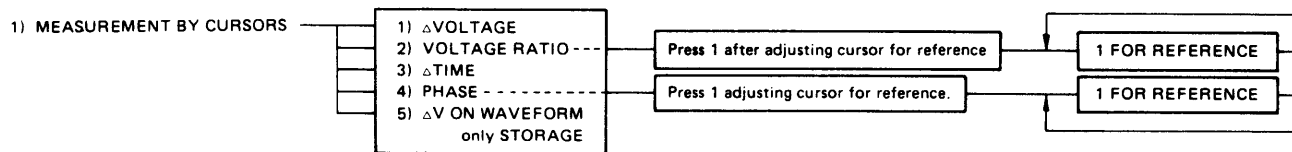

Using two cursors,  $\Delta$ voltage, voltage ratio,  $\Delta$ time, phase and  $\Delta V$  on waveform are measured.

Adjust the cursor position for measurement

with **CURSOR 1** and **CURSOR 2**.

When cursors are moving, the sign "WORKING" appears at the bottom of the CRT. Upon completion of cursor setting, "WORKING" sign disappears and the value measured as the separation between the two cursors appears at the lower right corner of the CRT.

#### The Difference between $\Delta$ VOLTAGE and $\Delta V$ ON WAVEFORM

##### ① Functional Difference

$\Delta$ VOLTAGE: Irrelevant to the waveforms, potential difference between the two cursors is calculated and shown on the CRT screen.

$\Delta V$  ON WAVEFORM: Potential difference is calculated on the basis of captured waveform data and shown on the CRT screen.

##### ② Difference Upon Use

$\Delta$ VOLTAGE: Absolute voltage value can be measured if one of the cursors is fixed at the GND line upon measurement.

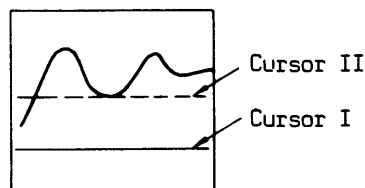

$\Delta V$  ON WAVEFORM: In the case as shown in the following figure, the peak value can be measured without moving the cursors even when the waveform amplitude fluctuates.

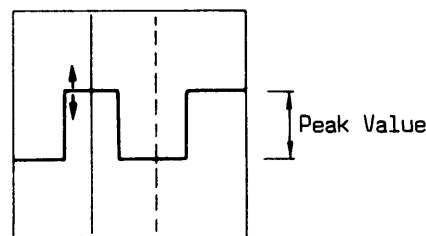

Described below is the example of measurement with CAL input and the following settings.

V. MODE CH 1  
VOLTS/DIV 0.2 V  
A TIME/DIV 0.2 ms

Press **1** while GUIDE MENU is displayed, and displays a figure as shown in Figure 3-7-1.

Next, press the numerical key **1** to **5** to select FUNCTION for the measurement.

Figure 3-7-1. Example of Measurement by Cursors

---

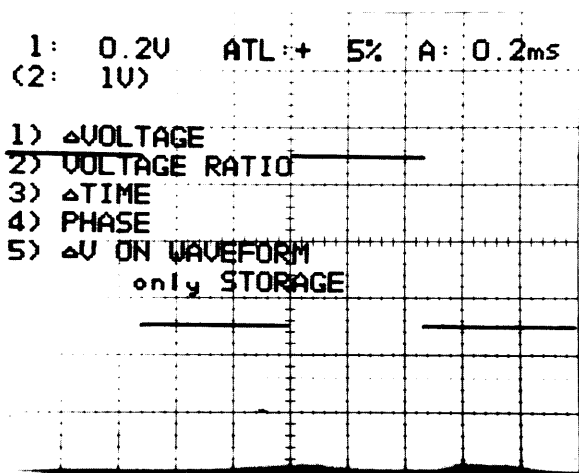

### 3-7-1-1 ΔVOLTAGE

Measures potential difference between two cursors. When the cursor 2 is upper and the cursor 1 lower, indicates "+". When the Y axis deflection factor is uncal, indicates a unequal mark ">" or "<".

#### Procedure

- ① Press **1** while Figure 3-7-1 is displayed.
- ② Adjust the cursors positions for measurement with two cursors. Measured results are displayed at the lower right corner on the CRT.

#### Unit and Unequal mark

Refer to table below.

| STORAGE       | Measuring Item | Unit | Measuring Result |   |
|---------------|----------------|------|------------------|---|
|               |                |      | +                | - |
| OFF<br>(REAL) | Except ADD     | V    | >                | < |
|               | ADD            | div  |                  |   |
| ON            | Except +-x     | V    | >                | < |
|               | +-x            | div  |                  |   |

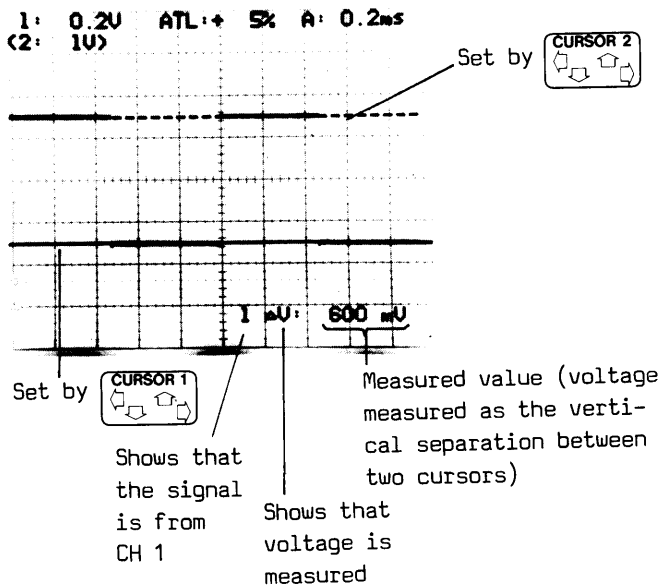

#### Caution

The sign is positive when the Cursor 1 is in the lower half of the screen.  
 The sign ">" is displayed when Y axis sensitivity is set at UNCAL.

### 3-7-1-2 VOLTAGE RATIO

The potential difference between the standard cursor positions set prior to the measurement is defined as 0 dB and 100%. The ratio of the voltage calculated against this standard difference for CH 1 or CH 2 measured by the two cursors is to be displayed both in percent (%) and in decibels (dB).

**Procedure**

- ① Press **2** while Figure 3-7-1 is displayed.
- ② Adjust the cursor position for measurement with two cursors.

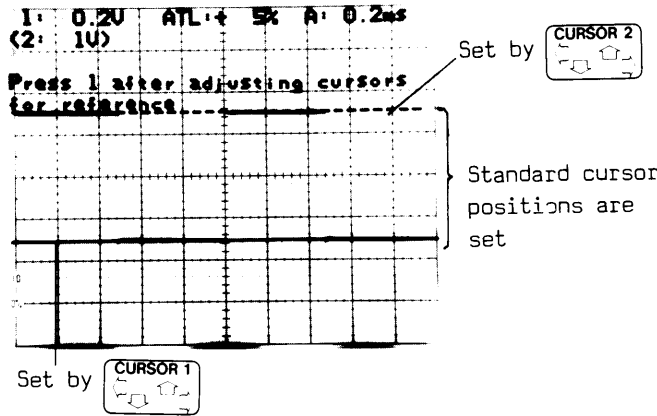

- ③ Press **1**, and the following is displayed (the value between two cursors are now set as 0.00 dB and 100%).

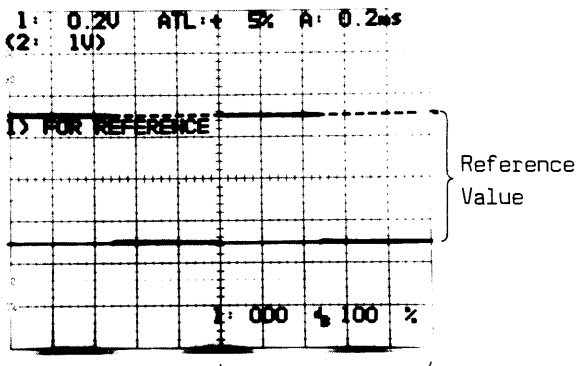

Indicates that the reference value is selected

- ④ For example, when the position of CURSOR 2 is set as in the figure below with **CURSOR 2** key, it is compared with the standard potential difference set in operation ③ above and 1.92 dB and 124% are indicated on the screen.

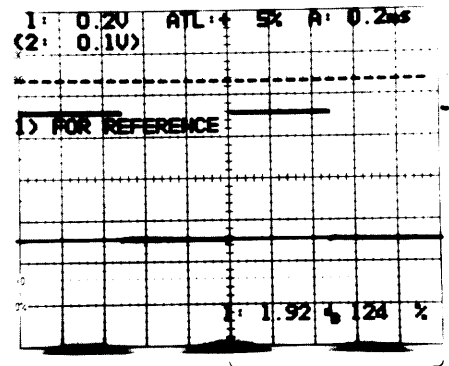

Indicates the ratio to the reference value

- ⑤ Press **4** again, and the values between two cursors are reset as 0.00 dB and 100%.

**Unequal Mark**

Refer to table below.

| STORAGE       | Measuring Item | Measuring Result |               |                |               |
|---------------|----------------|------------------|---------------|----------------|---------------|
|               |                | +                |               | -              |               |
|               |                | UNCAL<br>→ CAL   | CAL→<br>UNCAL | UNCAL<br>→ CAL | CAL→<br>UNCAL |
| OFF<br>(REAL) | Except ADD     | >                | <             | <              | >             |
|               | ADD            |                  |               |                |               |
| ON            | Except +-x     | >                | <             | <              | >             |
|               | +-x            |                  |               |                |               |

### 3-7-1-3 $\Delta$ TIME

The time difference two cursors and its reciprocal (frequency) are displayed in units of "s" and "Hz". Indicates "+" when the CURSOR 1 is on the left half of the screen.

#### Procedure

- ① Press 3 while Figure 3-7-1 is displayed.
- ② Adjust the cursor positions. Measured results are displayed at the lower right corner on the CRT.

#### Unequal Mark

Refer to table below.

| Display           | STORAGE    | Measuring Result |   |
|-------------------|------------|------------------|---|
|                   |            | +                | - |
| Time display      | OFF (REAL) | >                | < |
|                   | ON         |                  |   |
| Frequency display | OFF (REAL) | <                |   |
|                   | ON         |                  |   |

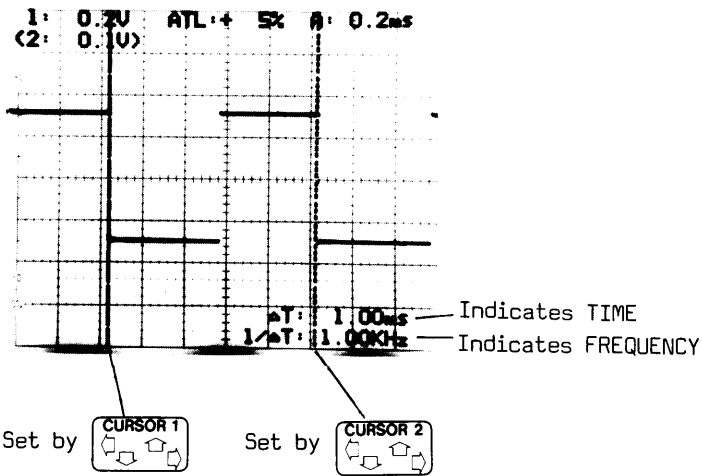

### 3-7-1-4 PHASE

One cycle of waveform is defined as 360 degrees and the phase measured by two cursors is displayed in unit of "degree". Indicates "+" when CURSOR 1 is on the left half of the screen.

**Procedure**

- ① Press **4** while Figure 3-7-1 is displayed.
- ② Adjust two cursors to bracket one cycle of waveform.

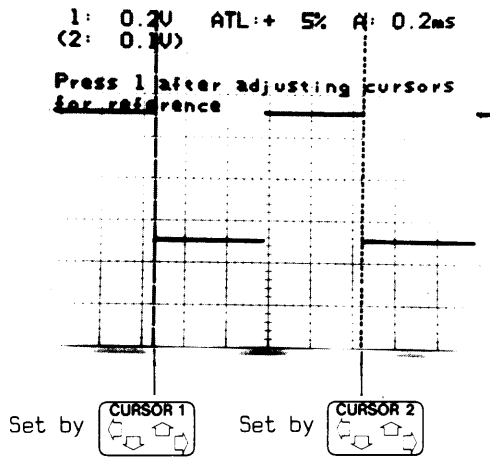

- ③ Press **1**, and the following is displayed. The phase between the two cursors are now defined as 360 degree.

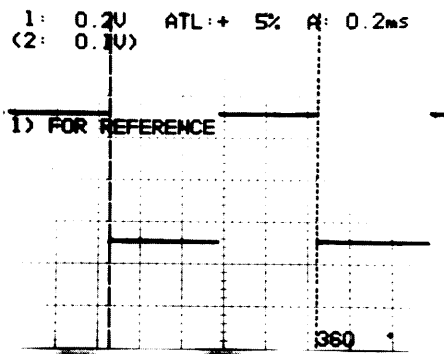

Setting of the phase for reference

- ④ When the position of the CURSOR 2 is set as shown in the figure below by **CURSOR 2** key, the measured phase difference between the two cursors is indicated as 440 degree at the lower right corner of the CRT.

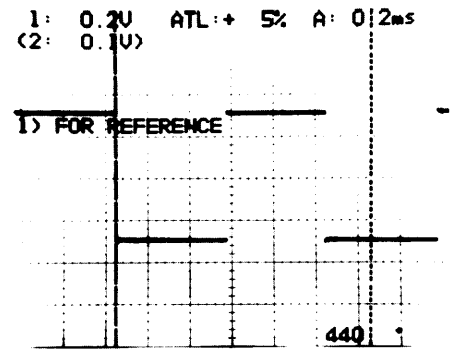

- ⑤ Press **1** again, and the value between two cursors in reset as 360 degree.

**Unequal Mark**

Refer to table below.

| STORAGE    | Measuring Result |                |                |                |
|------------|------------------|----------------|----------------|----------------|
|            | +                |                | -              |                |
|            | UNCAL<br>→ CAL   | CAL →<br>UNCAL | UNCAL<br>→ CAL | CAL →<br>UNCAL |
| OFF (REAL) | <                | >              | <              | >              |
| ON         |                  |                |                |                |

### 3-7-1-5 ΔV ON WAVEFORM

Measures potential difference between two wave-  
form with two cursors.

**Procedure**

- ① Set **STORAGE** to ON.
- ② Press **5** while Figure 3-7-1 is displayed.
- ③ Adjust the cursor position for measurement with two cursors. Measured results are displayed at the low right corner on the CRT.

**Caution**

- Effective even in arithmetic (+ - X) mode.
- x10 MAG mode is not allowed.
- Horizontal position is fixed at the center.

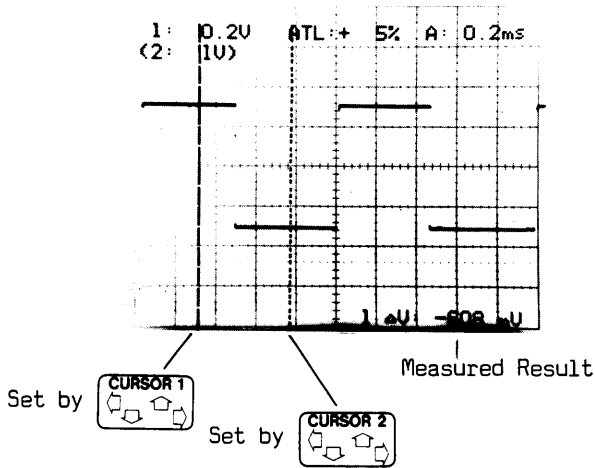

**Unit and Unequal Mark**

Refer to table below.

| STORAGE       | Measuring Item | Unit | Measuring Result |   |
|---------------|----------------|------|------------------|---|
|               |                |      | +                | - |
| OFF<br>(REAL) |                |      |                  |   |
| ON            | Except +-x     | V    | >                | < |
|               | +-x            | div  |                  |   |

## 3-7-2 SETUP RECALL/SAVE

### MENU

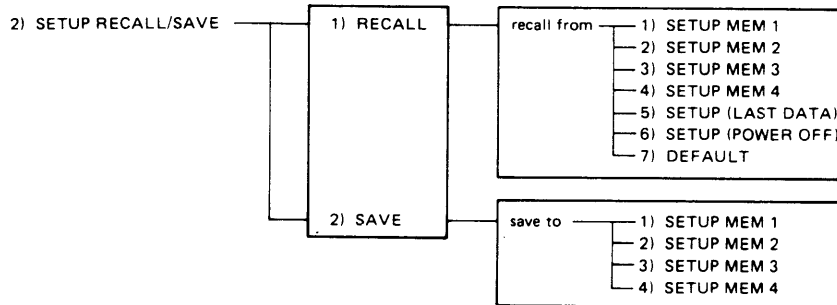

Settings made on the front panel can be saved in Memory 1 to 4 and recalled when necessary for confirmation. When LAST DATA, POWER OFF, or DEFAULT is selected, the relevant settings are automatically saved in memory, and can be recalled when necessary.

**SETUP (LAST DATA):** Settings made upon the last data entry while the power is on can be recalled even after the power is switched off.

**SETUP (POWER OFF):** Settings changed after the last data entry, for waveform magnification, etc., can be recalled even after the power is switched off.

**SETUP (DEFAULT):** Used for returning to the initial settings because of mistakes in setting, etc. Whenever the power is turned on, this DEFAULT setting is made.

The power for the memory is backed up by a battery.

Described below is example of operations concerning SAVE and RECALL of memory 1) to 4), RECALL of LAST DATA, POWER OFF, and DEFAULT under CAL input.



### 3-7-2-1 SAVE

#### Procedure I (Save to memory 1)

————— "SET UP State" Setting —————

- ① Display the waveform to be saved on the CRT.

Setting example:

```
V. MODE ALT
VOLTS/DIV 1 V
A TIME/DIV 5 ms
```

————— "SET UP RECALL/SAVE" Setting —————

- ② Press **2** while GUIDE MENU is displayed, and the following is displayed.

```
1) RECALL
2) SAVE
```

————— "SAVE" Setting —————

- ③ Press **2** again, and the following is displayed.

```
save to
1) SETUP MEM 1
2) SETUP MEM 2
3) SETUP MEM 3
4) SETUP MEM 4
```

————— "SAVE to" Selecting —————

- ④ Press **1**, and the following is displayed, and this waveform is saved in Memory 1.

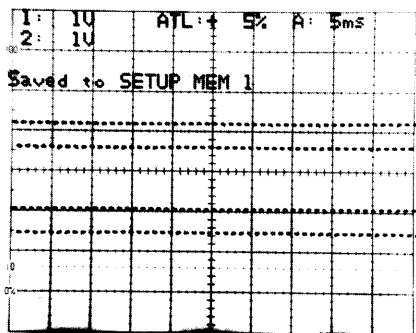

#### Procedure II (Save to memory 2)

- ① Display the waveform to be saved next on the CRT.

Setting example:

```
V. MODE ALT
VOLTS/DIV 1 V
A TIME/DIV 1 ms
```

- ② Operate as described in operation ②.
- ③ Operate as described in operation ③.
- ④ Press **2**, and the following is displayed (this waveform is saved in Memory 2).

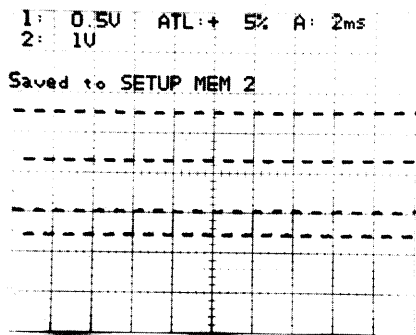

#### Procedure III (Save to memory 3)

Similarly, save the waveform with the following in Memory 3.

Setting example:

```
V. MODE ALT
VOLTS/DIV 0.5 V
A TIME/DIV 1 ms
```

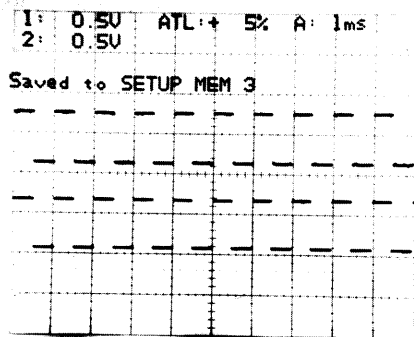

**Procedure IV (Save to memory 4)**

Similarly, save the waveform with the following setting in Memory 4.

Setting example:

|                |        |
|----------------|--------|
| V. MODE        | ALT    |
| CH 1 VOLTS/DIV | 0.2 V  |
| CH 2 VOLTS/DIV | 0.5 V  |
| A TIME/DIV     | 0.5 ms |

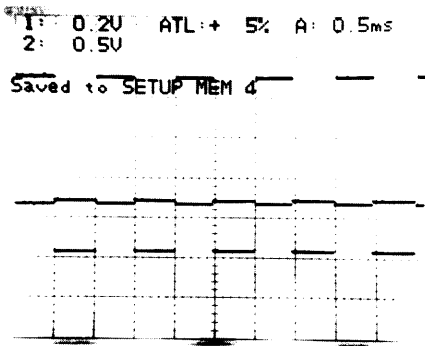

### 3-7-2-2 RECALL

**Procedure**

\_\_\_\_\_ "SETUP RECALL/SAVE" Setting \_\_\_\_\_

- ① Press **2** while GUIDE MENU is displayed, and the following is displayed.

- 1) **RECALL**
- 2) **SAVE**

\_\_\_\_\_ "RECALL" Setting \_\_\_\_\_

- ② Press **1**, and the following is displayed.

- ```
recall from
1) SETUP MEM 1
2) SETUP MEM 2
3) SETUP MEM 3
4) SETUP MEM 4
5) SETUP(LAST DATA)
6) SETUP(POWER OFF)
7) DEFAULT
```

_____ "Recall from" Setting _____

- ③ Press the numerical key corresponding the number of data to be recalled.

Described below is each of the recalled waveform.

1) SETUP MEM 1

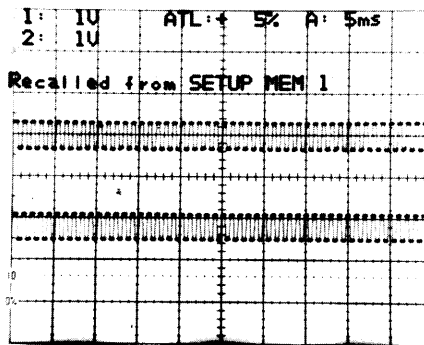

2) SETUP MEM 2

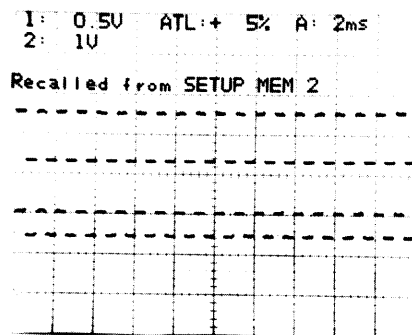

3) SETUP MEM 3

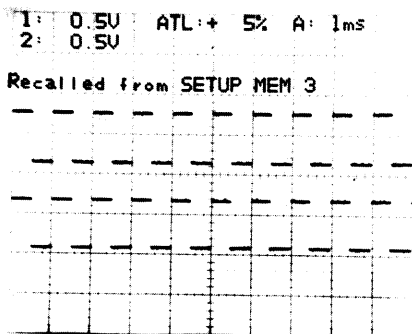

4) SETUP MEM 4

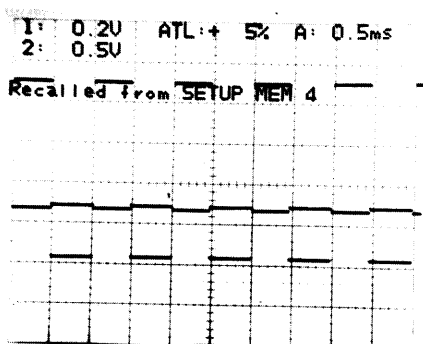

5) SETUP (LAST DATA)

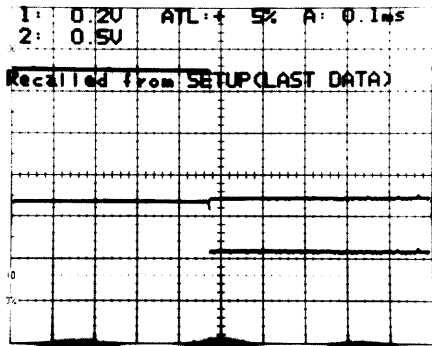

6) SETUP (POWER OFF)

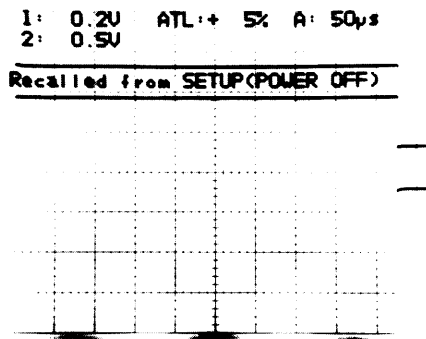

7) DEFAULT

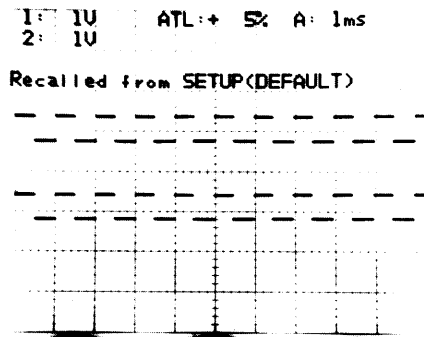

3-7-3 WAVEFORM RECALL/SAVE

MENU

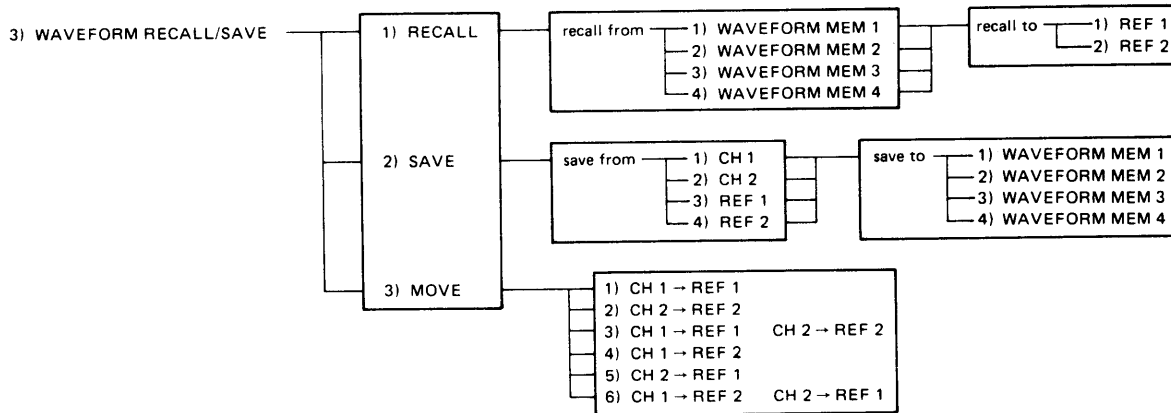

Used for saving in memory the waveforms which are to be stored, the standard one, or to be used for later comparison.

The power for the memory is backed up by a battery.

Described below is a measurement example which under CAL input, a signal from CH 1 is saved in memory 1 and a signal from CH 2 in memory 2, and recalled to REF 1 and REF 2 respectively.

3-7-3-1 SAVE

Procedure I (CH 1 signal to memory 1)

————— "STORAGE" and "V. MODE" Setting —————

- ① Set **STORAGE** to ON.
- ② Set V. **MODE** to CH 1 CH 2 & REF.

————— "SETUP State" Setting —————

- ③ Display the waveform to be saved on the CRT.
Setting example:
V. MODE CH 1
VOLTS/DIV 1 V
A TIME/DIV 1 ms

————— "WAVEFORM RECALL/SAVE" Setting —————

- ④ Press **3** while GUIDE MENU is displayed, and the following is displayed.

1) RECALL
2) SAVE
3) MOVE

————— "SAVE" Setting —————

- ⑤ Press **2** (SAVE is selected), and the following is displayed.

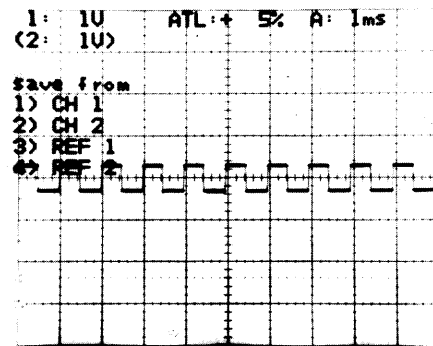

————— "Save from" Setting —————

- ⑥ Press **1** (CH 1 is selected), and the following is displayed.

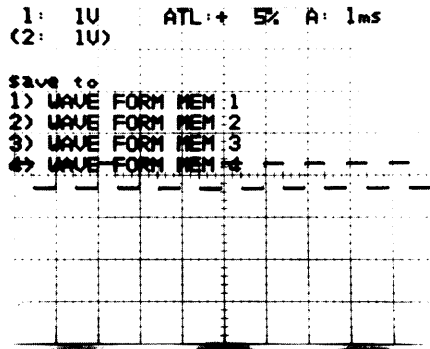

————— "Save to" Setting —————

- ⑦ Press **1** (WAVEFORM MEM 1 is selected), and the following is displayed (this waveform is saved in the Memory 1).

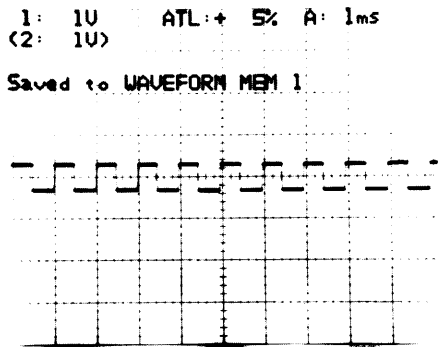

Procedure II (CH2 signal to memory 2)

- ③' Display the waveform to be saved next on the CRT.

Setting example:
 V. MODE CH 2
 VOLTS/DIV 0.5 V
 A TIME/DIV 2 ms

- ④' Repeat operation ④ above.
 ⑤' Repeat operation ⑤ above.
 ⑥' Press **2** (CH 2 is selected), and the following is displayed.

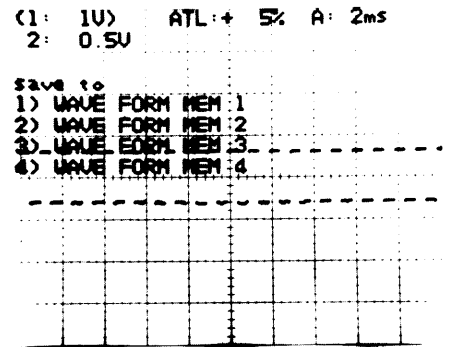

- ⑦' Press **2** (CH 2 is selected), and the following is displayed (this waveform is saved in the Memory 2).

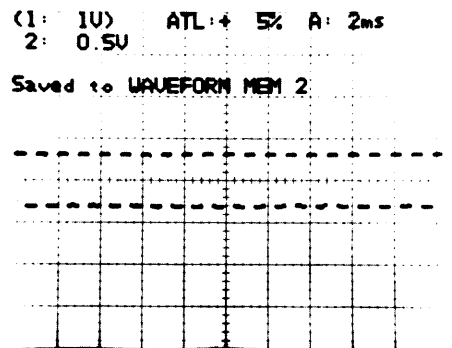

Other waveforms can be saved in this way.

3-7-3-2 RECALL

Procedure I (Memory 1 to REF 1)

—————"STORAGE" and "V. MODE" Setting ————

- ① Set **STORAGE** to ON.
- ② Set V. **MODE** to CH 1 CH 2 & REF.

—————"WAVEFORM RECALL/SAVE" Setting ————

- ③ Press **3** while GUIDE MENU is displayed, and the following is displayed.

```

1) RECALL
2) SAVE
3) MOVE
    
```

—————"RECALL" Setting ————

- ④ Press **1**, and the following is displayed.

```

recall from
1) WAVE FORM MEM 1
2) WAVE FORM MEM 2
3) WAVE FORM MEM 3
4) WAVE FORM MEM 4
    
```

—————"recall from" Setting ————

- ⑤ Press **1** again, and the following is displayed.

```

recall to
1) REF 1
2) REF 2
    
```

—————"recall to" Setting ————

- ⑥ Press **1** again, and the following figure is displayed, recalling the waveform saved by operations ③ to ⑧ described in the section 3-7-3-1 SAVE.

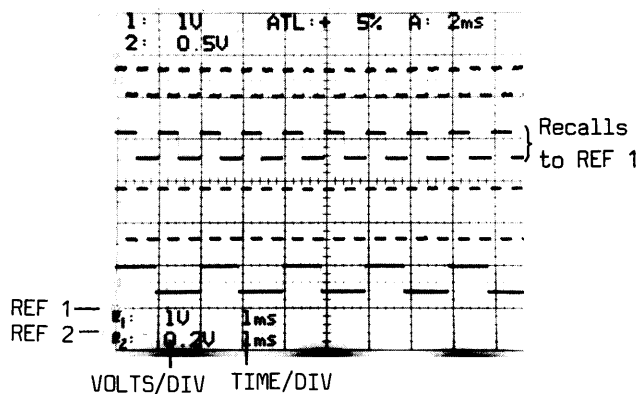

Procedure II (Memory 2 to REF 2)

Operate as described in operations ③ to ⑤.

- ⑥' Press **2**, and the following figure is displayed, recalling the waveform saved by operations ③ to ⑦ described in the section 3-7-3-1 SAVE.

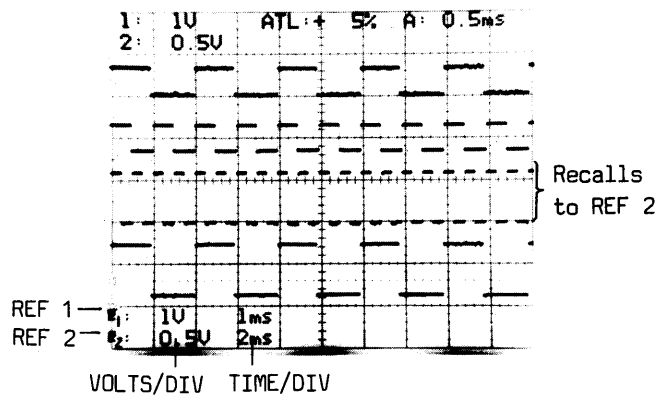

REF 1 and REF 2 Adjustment

Setting **2nd FUNC** to ON, vert position and deflection factor of REF 1 and REF 2 can be adjusted

with **POSITION** and **VOLTS/DIV**.

Observation of Four Phenomena by Using WAVEFORM MEMORY

Set **STORAGE** to ON and V. **MODE** set to REF, and simultaneous observation of two saved waveforms and two unsaved waveforms are possible. Respective flowcharts are shown below.

a. Display the recalled waveforms to REF 1 and REF 2

b. Display the waveforms of CH 1 and CH 2 without saving them

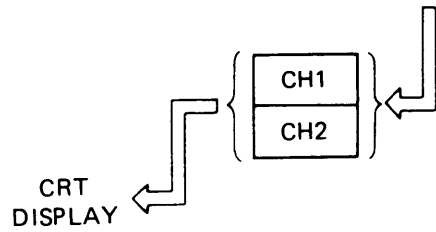
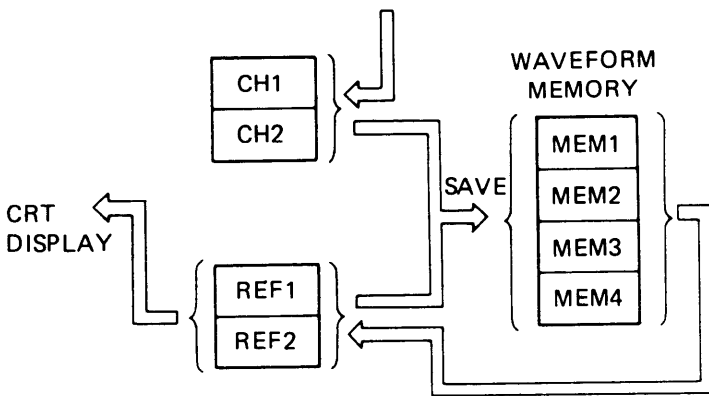

Measurement Example

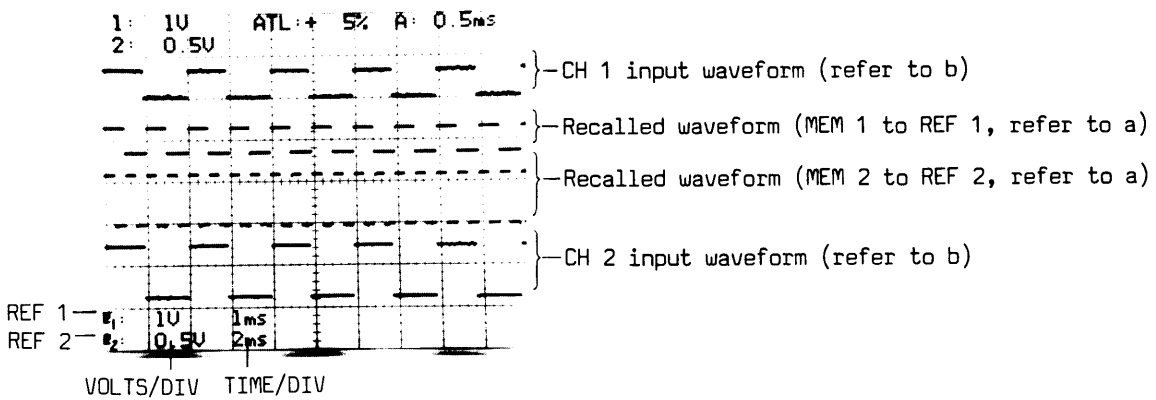

3-7-3-3 MOVE

Procedure (CH1 → REF 1, CH1 → REF 2)

- ① Set **STORAGE** to ON.
- ② Set V. **MODE** to CH 1 CH 2 & REF.

"WAVEFORM RECALL/SAVE" Setting

- ③ Press **3** while GUIDE MENU is displayed, while and the following is displayed.

- 1) **RECALL**
- 2) **SAVE**
- 3) **MOVE**

"MOVE" Setting

- ④ Press **3**, and the following is displayed.

- 1) CH1→REF1
- 2) CH2→REF2
- 3) CH1→REF1 CH2→REF2
- 4) CH1→REF2
- 5) CH2→REF1
- 6) CH1→REF2 CH2→REF1

"MOVE content" Selecting

- ⑤ Press **3** (select CH 1 → REF 1, CH 2 → REF 2), and the following is displayed.

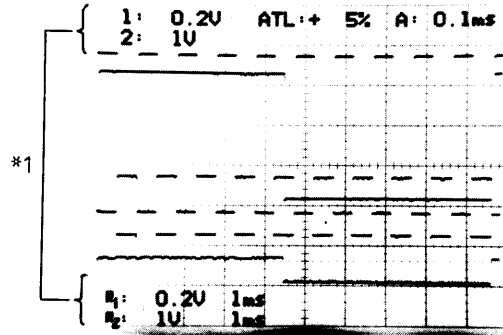

Indicates that the waveforms are moved from CH 1 display to REF 1 display and CH 2 to REF 2.

REF 1 and REF 2 Adjustment

Setting **2nd FUNC** to ON, vert position and deflection factor of REF 1 and REF 2 can be adjusted

with **POSITION** and **VOLTS/DIV**.

Observation of Four Phenomena without Using WAVE-FORM MEMORY

When **STORAGE** is set at DN and V. **MODE** set at REF, simultaneous observation of two moved waveforms and the unmoved waveforms is possible.

a. Display the moved waveforms to REF 1 and REF 2

b. Display the unmoved waveforms to CH 1 and CH 2

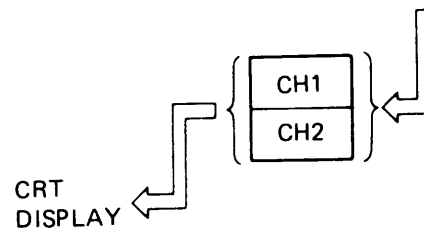
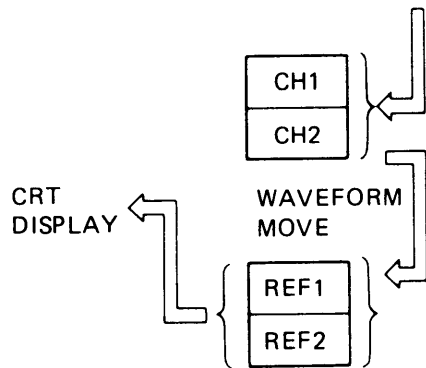

Measurement Example

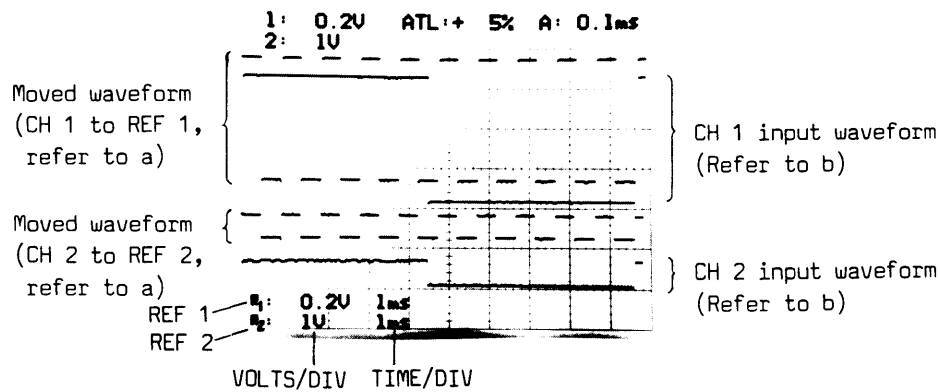

3-7-4 AVERAGING

MENU

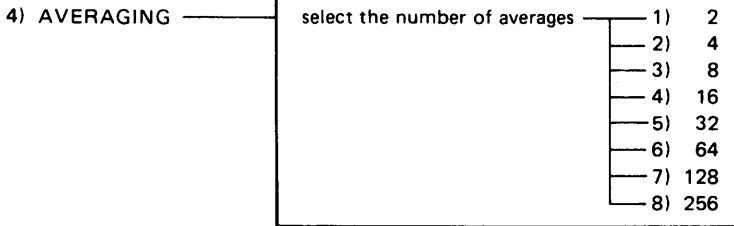

Used for extracting signals with regularity observed in noises. (A trigger signal triggered with that signal is necessary.)

Procedure

- ① Set STORAGE to ON.
- ② Press 4 while GUIDE MENU is displayed, and the following is displayed.

```

select the number of averages
1)  2
2)  4
3)  8
4) 16
5) 32
6) 64
7) 128
8) 256

```

- ③ Press 8 (256 is selected).
- ④ Press FREEZE (select OFF), and averaging is started.

Reference

Press FREEZE if averaging is to be interrupted.

On the CRT, the waveform averaged at 2^n th measurements immediately before interruption. Press

FREEZE again, and averaging is resumed.

Averaging Methode

The rate of noise component elimination is proportional to the square root of N, the number of measurements used for the AVERAGING.

For example, when AVERAGING is performed after 32 measurements, noise is reduced to 1/5.6 (15 dB).

Averaging is done at every 2^n measurements.

For example, if n is set at 5, data is rewritten at every 2, 4, 8, 16 and 32 measurements. When measurement by cursors is done at the same time, rewriting of the cursor is done at every 2^n measurement.

Described below is a measurement example when under sine wave input.

1) Before Averaging

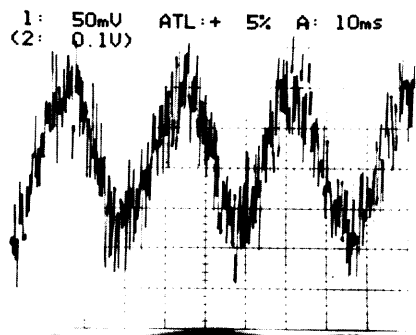

2) After Averaging

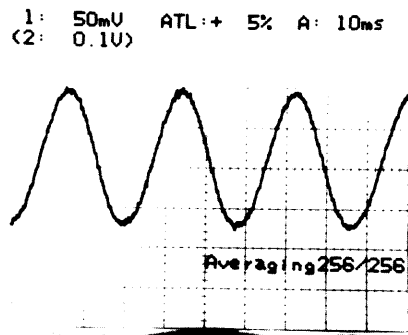

3-7-5 ENVELOPING

MENU

- 5) ENVELOPING (only CH 1)
 - 1) with MAX HOLD
 - 2) without MAX HOLD

Displays the envelope line of the waveform by detecting positive and negative peaks, and is useful in the following three cases (this function is CH 1 only).

The DS-6121A has analog peak hold circuit. It detects the maximum and the minimum values between sampling clocks and performs A/D conversion of these values.

This method is better is the detecting resolution of glitch than the other one that operates A/D convertor with the maximum sampling clock and detects the maximum and minimum values with a digital comparator.

- 1) Prevention of aliasing
- 2) Measurement of AM-modulated wave
- 3) Check of glitch
- 4) Measurement of frequency fluctuation

Prevention of Aliasing

When sampling rate is slower than the signal frequency, aliasing occurs. Aliasing can be prevented by using ENVELOPING function. Occurrence of aliasing can be checked by switching to the REAL mode.

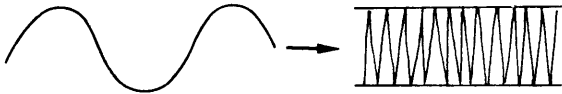

Aliasing Occurs
(Without ENVELOPING;
STORAGE Mode)

No Aliasing
(With ENVELOPING,
REAL Mode)

Measurement of AM-modulated Wave

An envelope of a rapidly changing signal can be observed in a slow range.

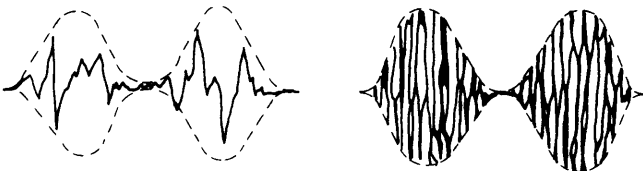

Without ENVELOPING

With ENVELOPING

Check of Glitch

When used with MAX HOLD function, glitches encountered at times can be detected.



Measurement of Frequency Fluctuation

When used with MAX HOLD function, the range of frequency fluctuation can be observed.

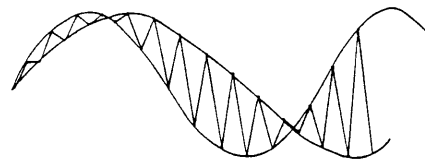

CAUTIONS

If the relation of the sampling clock frequency (f_s) and the input repetitive signal frequency (f_i) is

$$f_s = n \cdot f_i \quad \text{when } n = 1, 2, 3, \dots$$

the beat of f_s and f_i may appear.

There are two ways to avoid the beat.

- Set the difference of f_s and $n \cdot f_i$ to 4% or more by moving f_i .
- Set TIME/DIV to EXT CLOCK, and apply the clock signal that separate 4% or more from $n \cdot f_i$ to EXT CLOCK INPUT.
For setting of EXT CLOCK, refer to page 3-17.

Procedure

- ① Set **STORAGE** to ON.
- ② Press **5** while the GUIDE MENU is displayed and the following is displayed.

- 1) with MAX HOLD
- 2) without MAX HOLD

- ③ Press **1**, and **with MAX HOLD** is performed.
Press **2**, and **without MAX HOLD** is performed.

Measurement Example

1) with MAX HOLD

Press **1** in the step **3**.

Press **FREEZE** (Releasing of Freeze).

• Check of Glitch

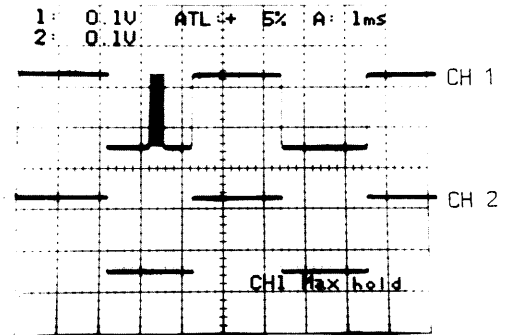

Glitch is checked at CH 1.

• Measurement of Frequency Fluctuation

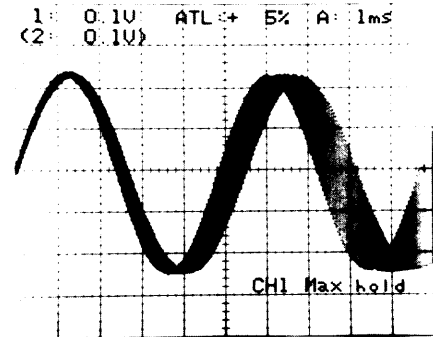

2) without MAX HOLD

Press **2** in the step **3**.

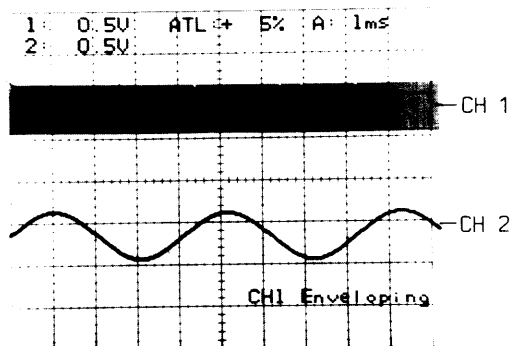

CH 1 Without Aliasing
CH 2 With Aliasing

Without MAX HOLD

MAX or MIN process is performed at every one sampling.

The following figure shows an example of AM-modulated wave measurement without and with ENVELOPING.

Figure 3-7-5-1. Waveform Without ENVELOPING

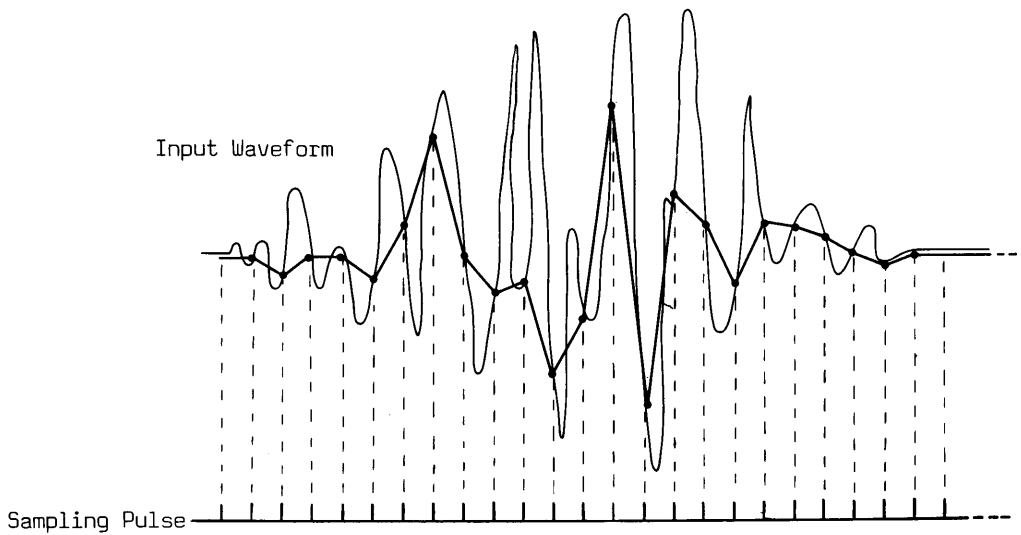
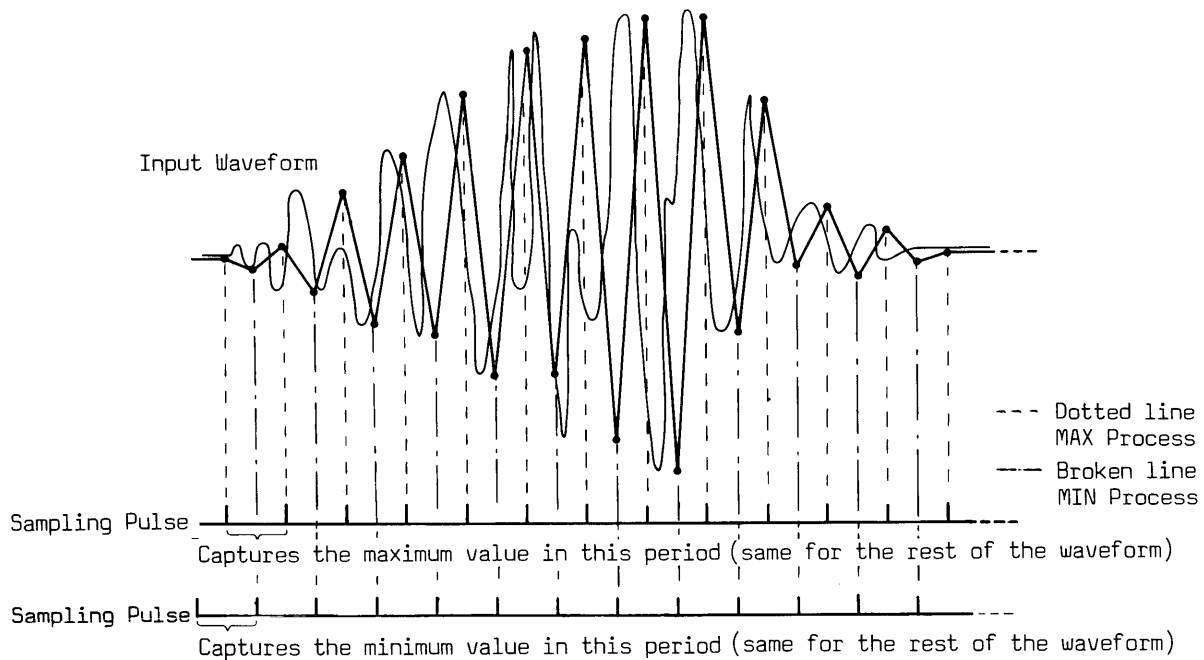

Figure 3-7-5-2. Waveform With ENVELOPING (without MAX HOLD)



With MAX HOLD

MAX or MIN process is performed in every sampling and the waveform is held.

• Measurement of Frequency Fluctuation

The following figure shows the measurement example when the waveform 1 is input first and the waveform 2 is input next (refer to Figure 3-7-5-3).

• Check of Glitch

The following figure shows the capture example when there are glitches at a and b (refer to Figure 3-7-5-4).

Figure 3-7-5-3. Measurement of Frequency Fluctuation

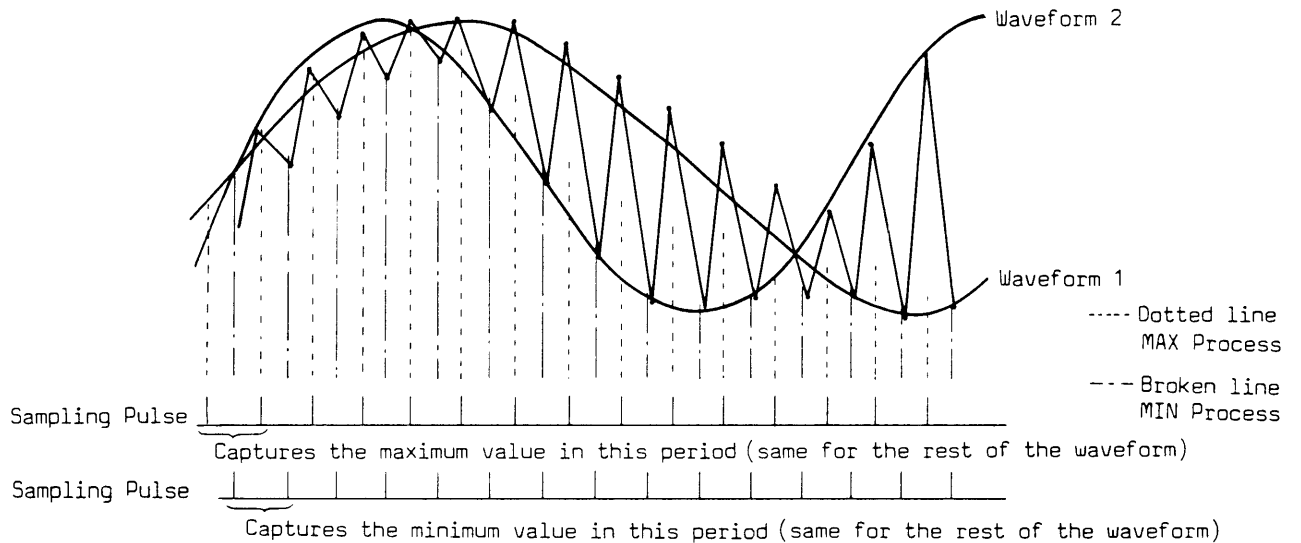
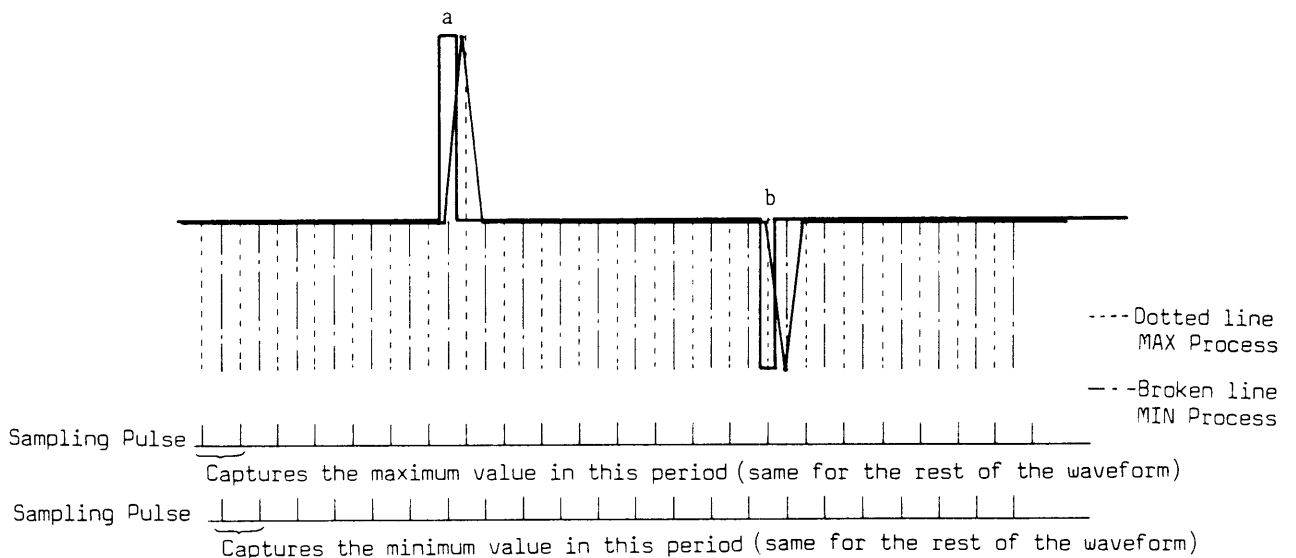

Figure 3-7-5-4. Check of Glitch



3-7-6 EQU-SAMPLING

Used when rapid repetitive signals are to be observed. Of two methods for equivalent sampling, random sampling and sequential sampling, the latter is employed in the DS-6121A.

In the case of repeated waveforms, those with frequency up to 100 MHz can be stored. This is effective at rate faster than 2 $\mu\text{s}/\text{DIV}$ in the case of CH 1, and faster than 5 $\mu\text{s}/\text{DIV}$ in the case of CH 2.

Described below is a measurement example

Procedure

- ① Set STORAGE to ON.
- ② Press 6 while GUIDE MENU is displayed, and Equ-sampling is performed.

1) Before Equ-sampling

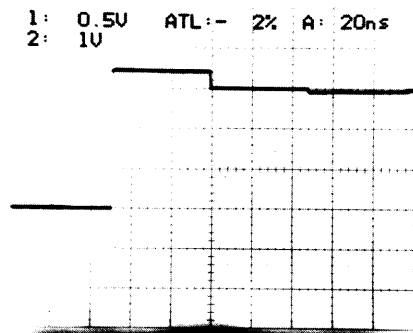

2) After Equ-sampling

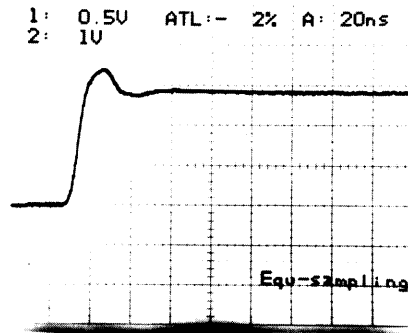

Caution

A normal waveform is not displayed unless trigger is appropriately applied.

When using this FUNCTION at high sensitivity (1 – 5 mV/DIV), special attention should be paid. When the trigger cannot be applied appropriately, set TRIGGER COUPLING at HF REF.

3-7-7 CURVE INTERPOLATION

Used to enhance the frequency characteristics further when the data quantity is reduced because the sweep time is in a rapid range, or the waveform was magnified.

This is effective only when the number of effective data on the CRT is 1/10.

Described below is a measurement example.

Procedure

- ① Set **STORAGE** to ON.
- ② Press **7** while GUIDE MENU is displayed, curve interpolation is performed.

When "WORKING" is displayed, it is in operation, and after interpolation is completed, "INTPLTING" is displayed. This is repeated. If interim observation is desired, press **FREEZE** key.

1) Before Curve Interpolation

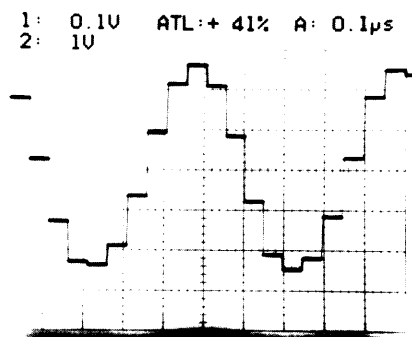

2) After Curve Interpolation

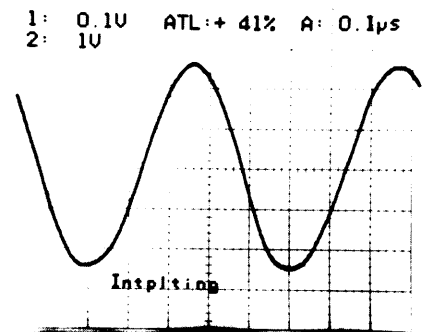

3-7-8 + - X

MENU

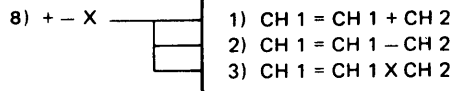

Displays a result of calculation between CH 1 input and CH 2 input in CH 1 display.

The following three calculations can be done.

CH 1 (Display) = CH 1 (Input) + CH 2 (Input)

CH 1 (Display) = CH 1 (Input) - CH 2 (Input)

CH 1 (Display) = CH 1 (Input) X CH 2 (Input)

In multiplying, the center on the CRT is defined as zero, and

(+1 DIV) X (+1 DIV) = +1 DIV

(+1 DIV) X (-1 DIV) = -1 DIV

Particularly, the multiplication mode is useful, for example, when an instantaneous power waveform is to be observed.

Example of calculation when CH 1 input is set at about 1.5 DIV above from the center, CH 2 input at about 1 DIV below (V COUPL is set to DC for both CH 1 and CH 2).

Procedure

- ① Set **STORAGE** to ON.
- ② Press **8** while GUIDE MENU is displayed, and the following is displayed.
CH 1 about +1.5 DIV
CH 2 about -1.0 DIV

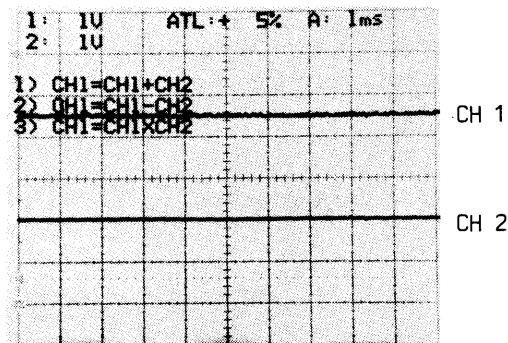

- ③ Press **1**, and addition is performed.
Press **2**, and subtraction is performed.
Press **3**, and multiplication is performed.

Addition

Press **1**, the following is displayed.

$$\text{CH 1 (Display)} = \text{CH 1 (+1.5)} + \text{CH 2 (-1)}$$

$$= 0.5 \text{ DIV}$$

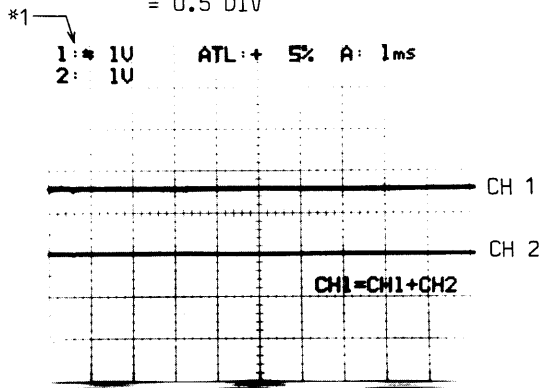

≠ Display (*1)

This shows that the calculation is conducted by the data displayed on the CRT (in divisions) irrelevant of the deflection factor. Therefore, CH 1 deflection factor display is ineffective and an unequality " " is displayed. Results of calculation are displayed on CH 1.

Subtraction

Press **2**, the following is displayed.

$$\text{CH 1 (Display)} = \text{CH 1 (+1.5)} - \text{CH 2 (-1)}$$

$$= 2.5 \text{ DIV}$$

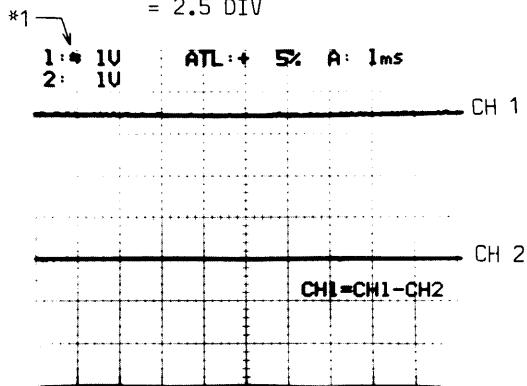

Multiplication

Press **3**, the following is displayed.

$$\text{CH 1 (Display)} = \text{CH 1 (+1.5)} \times \text{CH 2 (-1)}$$

$$= 1.5 \text{ DIV}$$

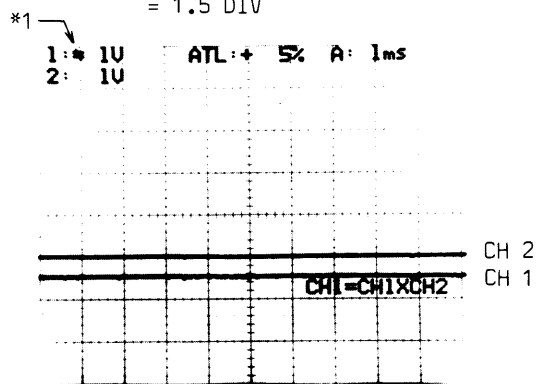

3-7-9 GO/NO GO

MENU

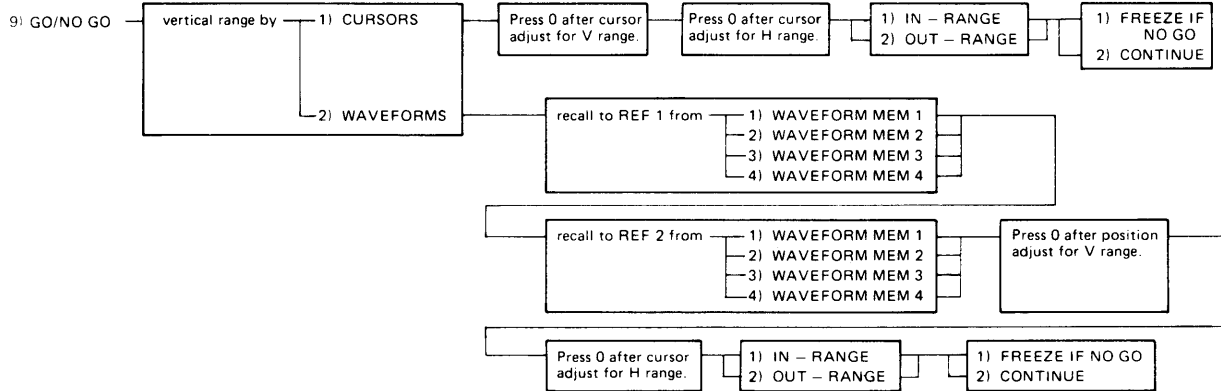

Used for determining whether the observed waveform is within the specified range or not.

Useful in automatic control or automatic judgement.

The judgement is done by indicating IN-RANGE or OUT-RANGE.

Method 2

Horizontal axis	Cursor 1	Left
	Cursor 2	Right
Vertical axis	Cursor 1 or REF 1	Upper
	Cursor 2 or REF 2	Lower

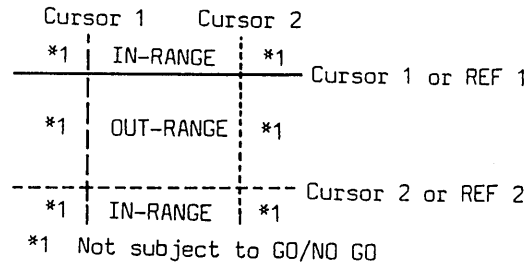

Setting of Measuring Range

a) CURSORS

Both vertical and horizontal axes are to be set by cursors.

b) WAVEFORMS

The vertical axis is set by two waveforms recalled from REF 1 and REF 2, and the horizontal axis by the cursor.

Method 3

Horizontal axis	Cursor 1	Right
	Cursor 2	Left
Vertical axis	Cursor 1 or REF 1	Lower
	Cursor 2 or REF 2	Upper

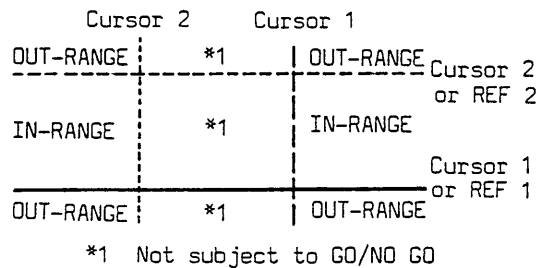

Setting of IN-RANGE and OUT-RANGE

The following four methods are provided for setting IN-RANGE or OUT-RANGE.

Method 1

Horizontal axis	Cursor 1	Left
	Cursor 2	Right
Vertical axis	Cursor 1 or REF 1	Lower
	Cursor 2 or REF 2	Upper

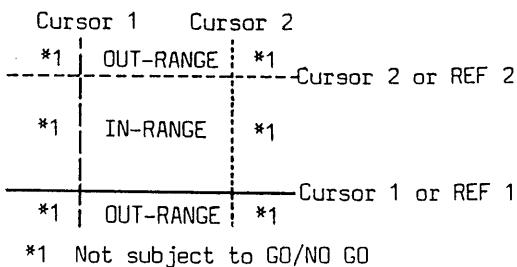

Method 4

Horizontal axis	Cursor 1	Right
	Cursor 2	Left
Vertical axis	Cursor 1 or REF 1	Upper
	Cursor 2 or REF 2	Lower

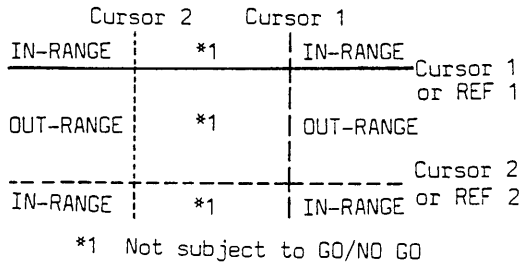

GO/NO GO Setting

IN-RANGE:

When waveform is within "IN-RANGE"
IN-RANGE GO
When waveform is without "IN-RANGE"
IN-RANGE NO GO

OUT-RANGE:

When waveform is within "OUT-RANGE"
OUT-RANGE GO
When waveform is without "OUT-RANGE"
OUT-RANGE NO GO

Measurement Example

1) Overshoot Judgement

Assumed specifications: Overshoot 3% or less
The vertical cursor 2 is adjusted to the position of 3% level.

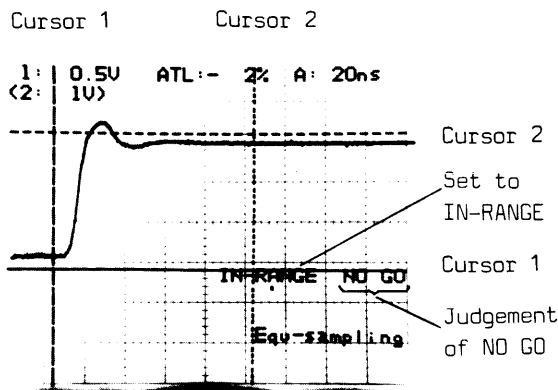

The figure above shows judgement of NO GO since the overshoot of input waveform is over 30%.

2) Detection of Abnormal Signals

Assumed specifications: No glitches at the lower level part of the pulse waveform.

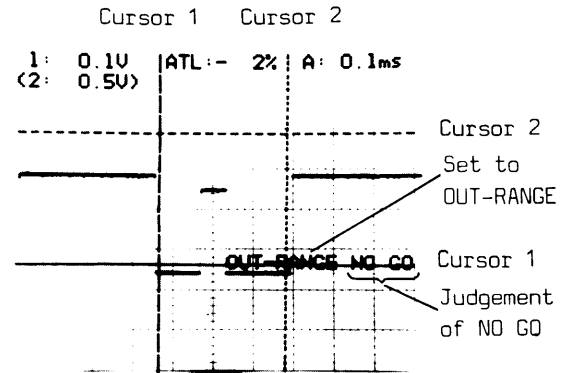

The figure above shows judgement of NO GO since there is a glitch.

3) Waveform Judgement

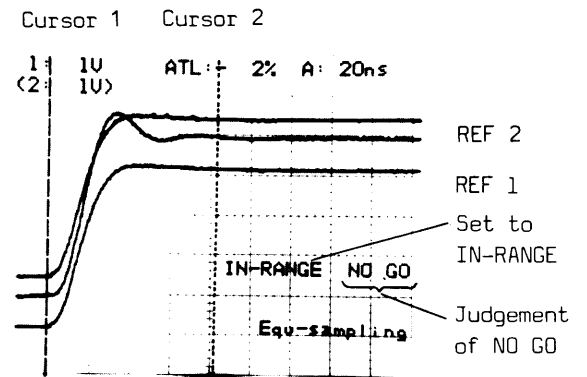

The figure above shows judgement of NO GO since the waveform is out of the range set by REF 1 and REF 2.

3-7-8-1 CURSORS

Described below is the measurement example when the following setting is made under CAL input.

V. MODE CH 1
 VOLTS/DIV 1 V
 A TIME/DIV 0.5 ms

Procedure

————— "STORAGE" Setting —————

- ① Set **STORAGE** to ON.

————— "GO/NO GO" Setting —————

- ② Press **9** while GUIDE MENU is displayed, and the following is displayed.

```

vertical range by
1) CURSORS
2) WAVEFORMS
    
```

————— "CURSORS" Setting —————

- ③ Press **1**, and the following is displayed.

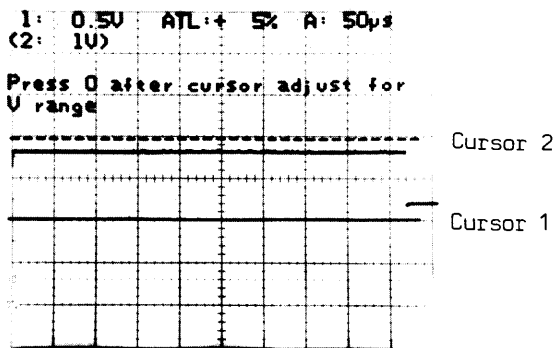

————— "V. Cursors" Adjustment —————

- ④ Adjust the vertical positions of the cursors with **CURSOR 1** and **CURSOR 2** keys.

- ⑤ Press **0**, and the following is displayed.

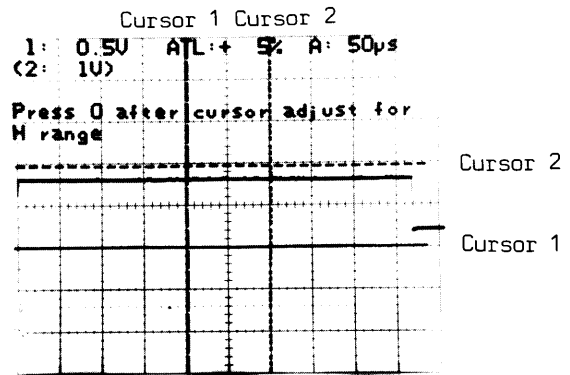

————— "H. Cursors" Adjustment —————

- ⑥ Adjust the horizontal positions of cursors with **CURSOR 1** and **CURSOR 2** keys.
- ⑦ Press **0**, and the following is displayed.

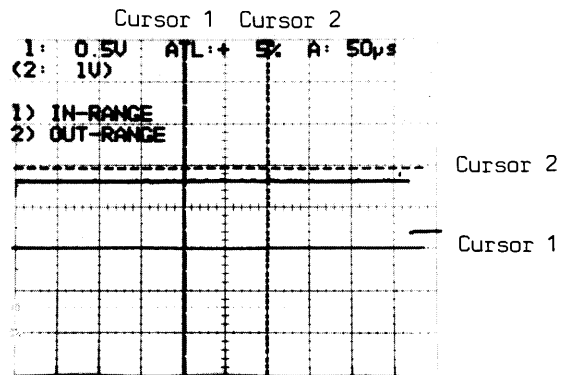

————— "IN-RANGE or OUT-RANGE" Selecting —————

- 1) IN-RANGE is subject to NO GO operation.
 2) OUT-RANGE is subject to NO GO operation.

- ⑧ Press **1** (IN-RANGE GO is selected), and the following is displayed.

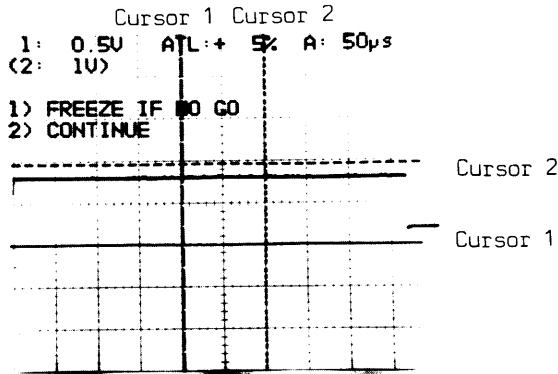

- 1) FREEZE IF NO GO
When the range is outside of two cursors (NO GO), FREEZE is effectuated.
- 2) CONTINUE
Even when the range is outside of two cursors (NO GO), FREEZE is not effectuated.

————— "FREEZE or CONTINUE" Selecting —————

- ⑨ Press **1** (FREEZE IF NO GO is selected), and the following is displayed.
The waveform is within two cursors, and "IN RANGE GO" is displayed.

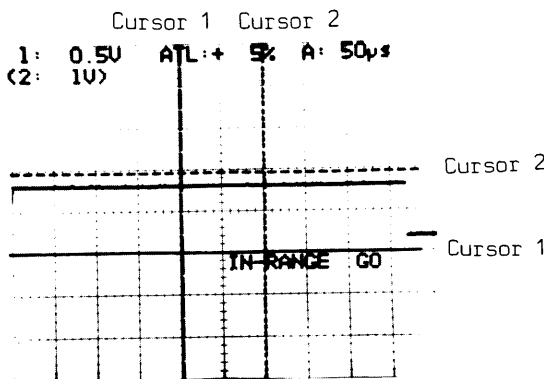

When the input signal is as shown in the following, the range is outside of the two cursors, and "IN-RANGE NO GO" is displayed. As FREEZE IF NO GO was selected in the operation ⑨ the waveform is frozen.

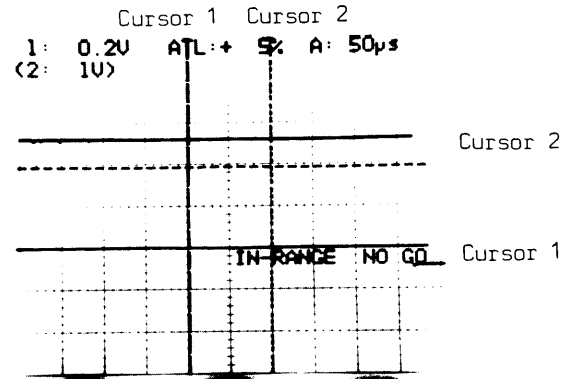

3-7-9-2 WAVEFORMS

Described below is the measurement example when the following setting is made.

V. MODE CH 1
 VOLTS/DIV 1 V
 A TIME/DIV 0.5 ms

Procedure

"STORAGE and V. MODE" Setting

- ① Set **STORAGE** to ON.
- ② Set V. **MODE** to CH 1 CH 2 & REF.

"GO/NO GO" Setting

- ③ Press **9** while GUIDE MENU is displayed, and the following is displayed.

```
vertical range by
1) CURSORS
2) WAVEFORMS
```

"WAVEFORMS" Setting

- ④ Press **2** (WAVEFORM), and the following is displayed.

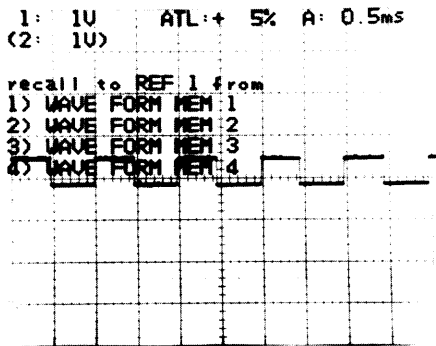

"recall to REF 1 from" Selecting

The number of the memory to be recalled to REF 1 is selected from 1) to 4).

- ⑤ Press **1** (WAVEFORM MEM 1), and the following is displayed.

```
1: 1U   ATL:+ 5% A: 0.5ms
(2: 1U)
```

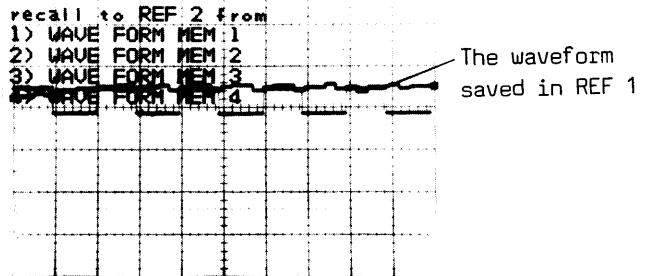

"recall to REF 2 from" Selecting

The number of the memory to be recalled to REF 2 is selected from 1) to 4).

- ⑥ Press **2** (WAVEFORM MEM 2), and the following is displayed.

```
1: 1U   ATL:+ 5% A: 0.5ms
(2: 1U)
```

Press 0 after position adjust for V range

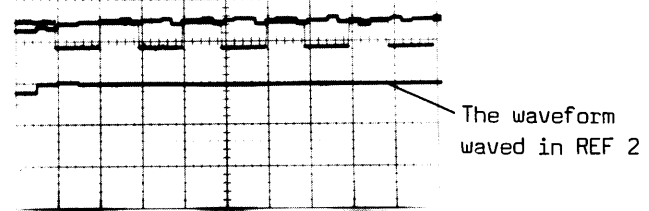

"REF 1, 2 V. Position" Adjustment

- ⑦ Set **2nd FUNC** to ON.
- ⑧ Adjust the vertical position of cursors using



```
1: 1U   ATL:+ 5% A: 0.5ms
(2: 1U)
```

Press 0 after position adjust for V range

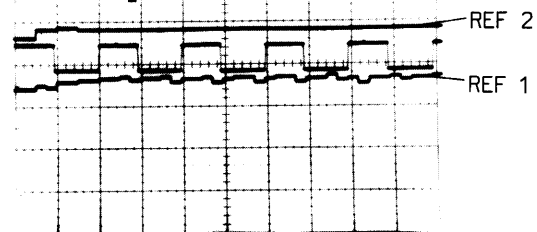

- ⑨ Press **0**, and the following is displayed.
Cursor 1 Cursor 2

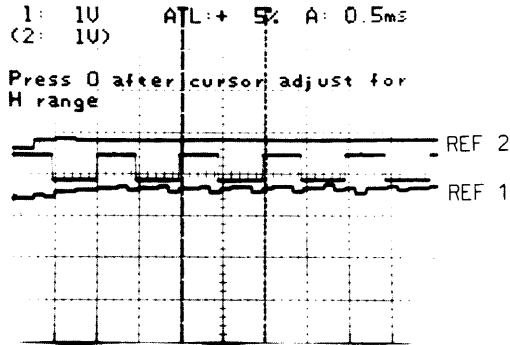

———— "H. Cursors" Adjustment ————

- ⑩ Adjust the horizontal positions of cursors

with **CURSOR 1** and **CURSOR 2**.

- ⑪ Press **0**, and the following is displayed.

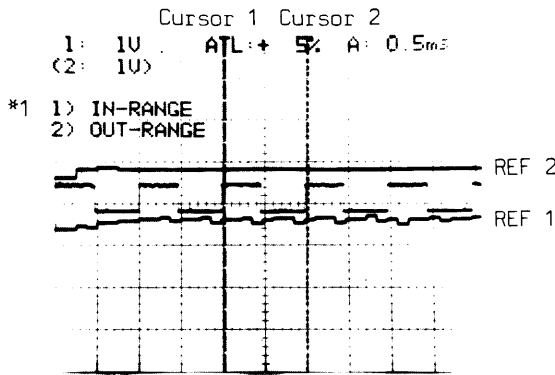

———— "IN-RANGE or OUT-RANGE" Selecting ————

- | |
|---|
| <p>1) IN-RANGE is subject to GO operation.
2) OUT-RANGE is subject to GO operation.</p> |
|---|

- ⑫ Press **1** (IN-RANGE is selected), and the following is displayed.

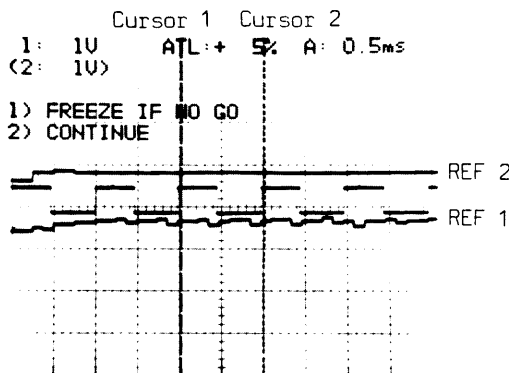

———— "FREEZE or CONTINUE" Selecting ————

- | |
|---|
| <p>1) FREEZE IF NO GO
When NO GO, FREEZE is effectuated.</p> <p>2) CONTINUE
Even when NO GO, FREEZE is effectuated.</p> |
|---|

- ⑬ Press **1** (FREEZE IF NO GO is selected), the following is displayed.
As the waveform is within the two cursors, the state is "IN-RANGE GO".

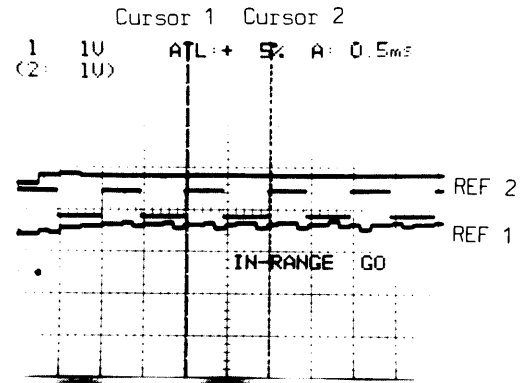

When the waveform is in a position as shown in the following figure, it is outside of the two cursors and the state is "IN-RANGE NO GO". As FREEZE IF NO GO was selected, the waveform is frozen.

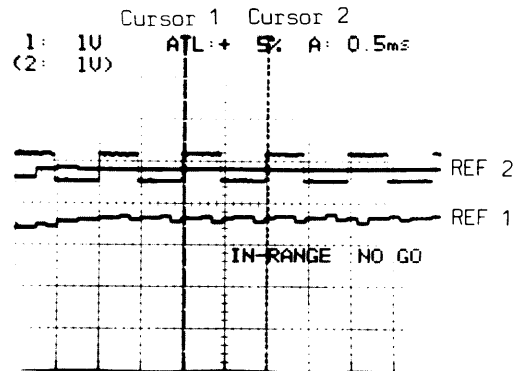

*1

- 1) IN-RANGE
The range between two cursors is subject to NO GO operation.
- 2) OUT-RANGE
The range outside of two cursors is subject to NO GO operation.

3-7-10 WAVEFORM OUT

MENU

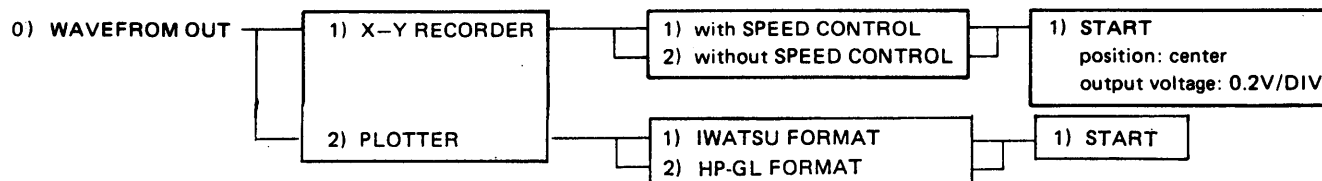

Using an X-Y recorder or a plotter (SR-6602, SR-6620, or SR-6625 of IWATSU format and SR-6620H, HP-7440A, HP-7470A, HP-7475A of HP-GL format), hard-copies of waveforms on the CRT can directly be obtained.

Output Operations on X-Y recorder

Settings on the Rear Panel

- ① Turn STORAGE/REAL on switch on the rear panel to STORAGE.

Connection to the X-Y recorder

- ② Connect X OUT, Y OUT, and PEN UP on the rear panel of the DS-6121A to X INPUT, Y INPUT, and PEN UP INPUT of the X-Y recorder with cables, respectively.

Settings on the X-Y Recorder

- ③ Adjust the deflection factor and pen position of the X-Y recorder.
Deflection factor: Both X and Y outputs of DS-6121A are in the unit of 0.2 V per one DIV on the CRT.
Pen position: This is because both X and Y outputs of DS-6121A are zero volt, which corresponds to the center of the CRT, until the recorder is started by pressing **1** key.

Settings on the Front Panel

- ④ Press **0** on the GUIDE MENU and the following is displayed.

1) X-Y RECORDER
2) PLOTTER

- ⑤ Press **1** and the following is displayed.

1) with SPEED CONTROL
2) without SPEED CONTROL

- 1) with SPEED CONTROL
When the waveforms greatly change, the output is given with slow speed.
When changing small, the output is given with high speed.

- 2) without SPEED CONTROL
Whether the waveforms change small or greatly, the output is given with constant speed.

- ⑥ Select the pen speed. Press **1** or **2** and the following is displayed.

1) START

POSITION: Center
Output voltage: 0.1 V/DIV

- ⑦ Press **1** and the recorder is started.

Output Operations on the Plotter

Interface unit setting

- ① • When GP-IB is to be used, set any one of INSTRUMENT ADDRESS switches 1 to 5 to "1" side. Refer to 4-2 ADDRESSING (page 4 - 4).
- When RS-232-C is to be used, refer to 5-2 SETTING OF SWITCHES (page 5 - 8).

Attachment of Package

- ② Insert GP-IB or RS-232-C package to the hole on the rear panel, and connect it to the plotter with a relevant cable.

Settings on the Plotter

- ③ When the SR-6620 model is to be used, set the stepsize at 0.1 mm.
- ④ Adjust the plotter pen position.

Key Operations

- ⑤ Press **0** on the GUIDE MENU and the following is displayed.
 - 1) X-Y RECORDER
 - 2) PLOTTER
- ⑥ Press **2** and the following is displayed.
 - 1) IWATSU FORMAT
 - 2) HP-GL FORMAT
- ⑦ In case of using IWATSU format, press **1**.
In case of using HP-GL format, press **2**.
and **1) START** is displayed.
- ⑧ Press **1** and the plotter is started.

Setting of HORIZONTAL POSITION

Though the horizontal position of waveform on CRT will be moved by **POSITION** and **FINE**, the horizontal position of waveform plotted in an X-Y recorder or a plotter will not move. Therefore, the waveforms on CRT and that plotted on an X-Y recorder or a plotter may differ in horizontal position.

To move the horizontal position plotted on an X-Y recorder or a plotter, set **HORIZ DISPLAY** to A, move it by CH 1 POSITION and change to X-Y mode.

On the Range of Plot

In an X-Y recorder and a plotter, the plot will go beyond the right-end scale by 12 data as shown in the figure below.

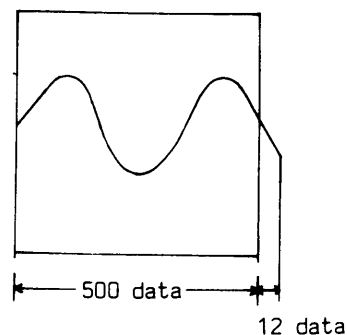

CAUTION

When being a difference of position between X-Y recorder/plotter drawing and CRT display, adjust the cursor position in accordance with "3-8 Adjustment of real/storage waveform cursor position".

Plotter setting

IWATSU FORMAT

Set the plotter's SW1 and SW2 as shown in Figure below.

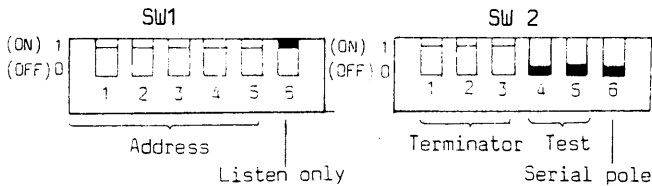

Address (SW1 to 5): Option

Listen only (SW1 6): ON

Terminator (SW2 1 to 3): Same as delimiter of
DS-6121A

Test (SW2 4 and 5): OFF

Serial pole (SW2 6): OFF

Caution on SR-6602

Each time the SR-6602 plotter is used with the DS-6121A, you must manually initialize operation as follows:

Procedure

1. Press **QUIT LOCAL** key, the plotter pen is set to HOME POSITION:
2. Turn the SR-6602's POWER switch off.
3. Set the pen position to initial setting position (Refer to the SR-6602's instruction manual.)
4. Turn the SR-6602's POWER switch on.

HP-GL FORMAT

Set to the plotter as follows.

1. Set the paper size to "A4".
2. For GP-IB interface: Set to listen only.
3. For RS-232-C interface: Set the baud rate and the parity to the same as for DS-6121A.

Connection to SR-6620 or SR-6625

When used with SR-6620 or set the stepsize changeover pin inside the plotter to 0.1 mm (see the next page). Otherwise, a square frame will be drawn as shown below.

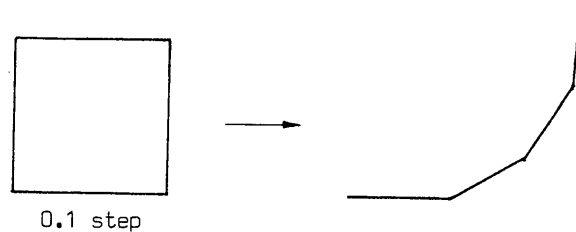

On the Character Display of Plotter

Some characters plotted by a plotter may differ from those on CRT.

On CRT	On Plotter
↖	!
↓	-

- In HP-GL format, "μ" is output as "u".

If a wrong format is selected with a guide menu:

- a. For GP-IB

An error will be indicated on the plotter when connecting the plotter of HP-GL format, selecting the IWATSU format in step ⑦ and pressing **1** (to start the plotter) in step ⑧ or vice versa. In this case, the instrument provides the data to the plotter, but the plotter does not output them. On completion of transferring all the data, the instrument will return to the previous condition.

Press **QUIT LOCAL** key to interrupt transfer.

- b. For RS-232-C

• Press **QUIT LOCAL** key twice to reset when connecting the plotter of HP-GL format, selecting the IWATSU format in step ⑦ and pressing **1** (to start the plotter) in step 8 .

• Press **QUIT LOCAL** key once to reset when connecting the plotter of IWATSU format, selecting the HP-GL format in step ⑦ and pressing **1** (to start the plotter) in step ⑧ .

Example for Construction (1) Plotter

IWATSU FORMAT

DS-6121A

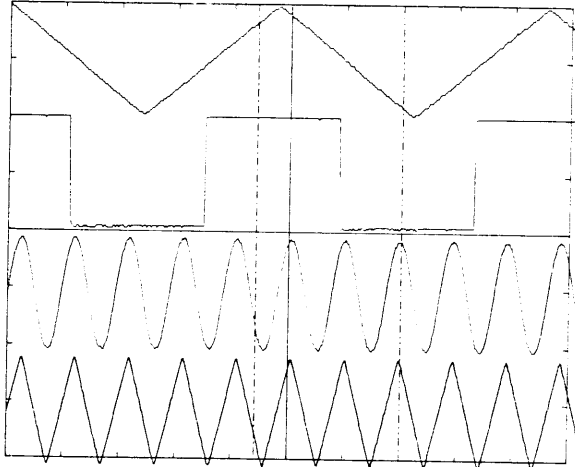

CH1 0.1V /DIV ATL + 5% (A 1ms /DIV) DTM 5.000
 CH2 0.1V /DIV B 0.2ms /DIV
 REF1 0.1V /DIV 1ms /DIV
 REF2 0.1V /DIV 1ms /DIV

CH1 dV -152 mV
 CH2 dV -192 mV

Averaging 16/ 16

Intplting

HP-GL FORMAT

DS-6121A

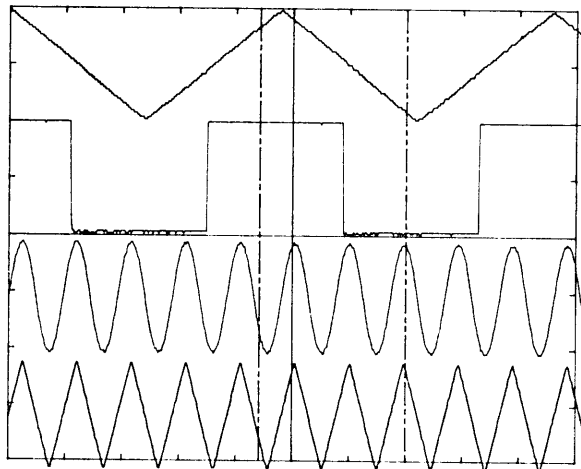

Averaging 16/ 16

Intplting

CH1 dV -152 mV

CH2 dV -192 mV

CH1 0.1V /DIV ATL + 5% (A 1ms /DIV) DTM 5.000 REF1 0.1V /DIV 1ms /DIV
 CH2 0.1V /DIV B 0.2ms /DIV REF2 0.1V /DIV 1ms /DIV

Example for Construction (II) X-Y recorder

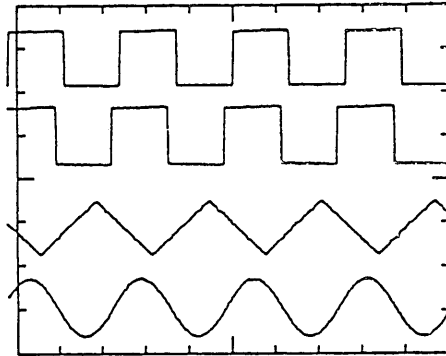

3-8 ADJUSTMENT OF CURSOR AND TRACE POSITIONS

3-8-1 Preparation

When being a difference of position between X-Y recorder/plotter drawing and CRT display, adjust as following procedures.

Set the instrument to the DEFAULT state by turning on or selection of SETUP RECALL. Allow the instrument to warm up (more than 30 minutes).

Be careful not to touch keys other than those specified. If any other key like the POSITION key is pressed by error, set the instrument to the DEFAULT state again to re-start the adjustment.

Do not apply signals to input connectors of CH1 and CH2.

3-8-2 Vertical Position

Adjustment of cursor position

Procedure

- Press keys as follows.



Two cursors are displayed on the CRT.

- Move down cursor 1 to get the ΔV reading of 400 mV with the CURSOR 1 key.
- Move up cursor 2 to get the ΔV reading of 600 mV with the CURSOR 2 key.
- Adjust cursor positions with SCOPE Y POSITION on the top.
Cursor 1: -3 div from the center
Cursor 2: +3 div from the center

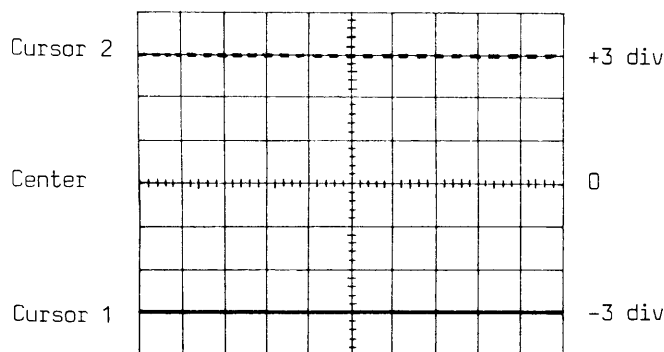

Adjustment of real trace positions

Procedure

- Adjust CH1 position with CH1 POSITION CENTER on the bottom.
CH1 position: +1 div from the center
- Adjust CH2 position with CH2 POSITION CENTER on the right side.
CH2 position: -1 div from the center

Adjustment of storage trace positions

Procedure

- Display the storage trace on the CRT by pressing the STORAGE key.
- Adjust CH2 position with CH1 A/D POSITION on the bottom.
CH1 position: +1 div from the center
- Adjust CH2 position with CH2 A/D POSITION on the right side.
CH2 position: -1 div from the center

3-8-3 Adjustment of Horizontal Position

Adjustment of cursor position

Procedure

- Press keys as follows in the DEFAULT
GUIDE MENU → 1 → 3
Two cursors are displayed on the CRT.
- Move cursor 1 to the left to get the ΔT reading of 5.00 ms with the CURSOR 1 key.
- Move CURSOR 2 to the right to get the ΔT reading of 8.00 ms with the CURSOR 2 key.
- Adjust the cursor positions with CHARACTER POSITION on the top.
Cursor 1: Right 4 div from the center
Cursor 2: Left 4 div from the center

- ⑤ Adjust the cursor positions with CHARACTER POSITION on the top.

Cursor 1: Right 4 div from the center
 Cursor 2: Left 4 div from the center

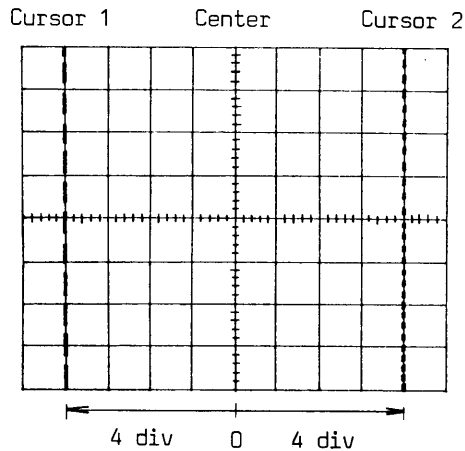
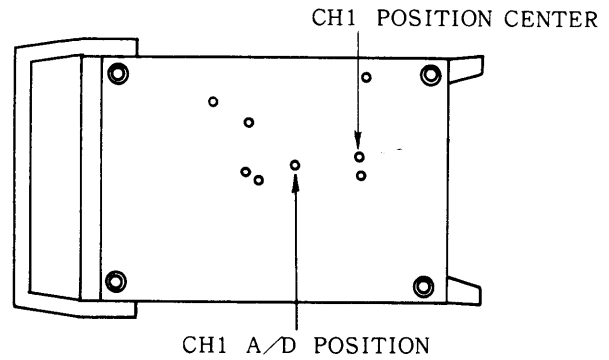
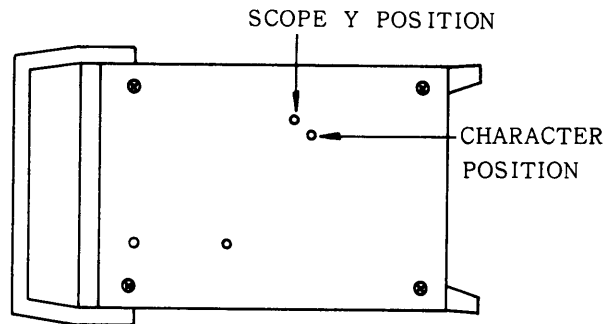

Figure 3-8. Adjustment Locations

Bottom



Top (With accessory bag removed)



Adjustment of storage waveform starting position

Procedure

- ① Adjust the cursor position.
- ② Display the storage trace on the CRT by pressing the **STORAGE** key.
- ③ Adjust starting point of the trace with SCOPE X POSITION on the right side.
 Start point: Left end line

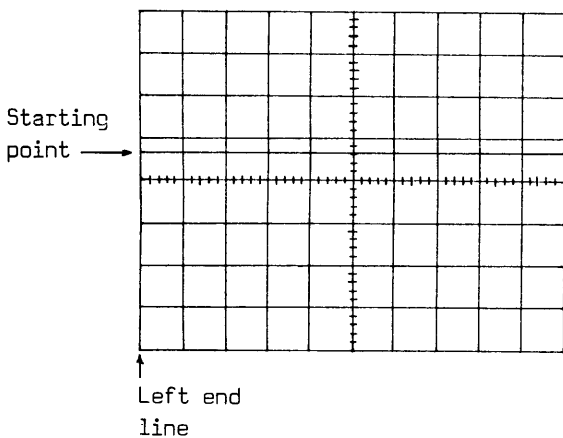

Right side

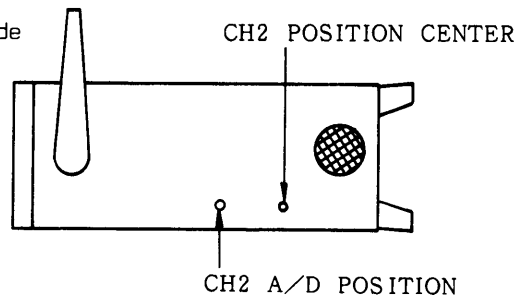

Left side

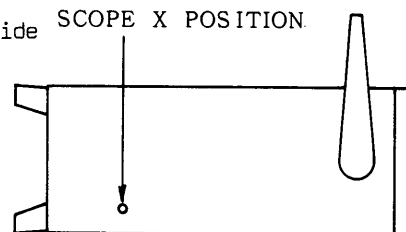

GLOSSARY

ACCURACY:

The degree to which a measured or calculated value conforms to the accepted standard or rule. The instruments ability to indicate a value corresponding to the absolute value. Accuracy is contrasted with precision.

ALIASING:

Pushing a digital storage scope past its limits results in errors different from those you encounter with an analog scope used past its limits. This kind of error is aliasing, and there is only one way to avoid it. Always digitize more than twice as fast as the highest frequency in the signal. The simplest way to do that is make sure you pick a TIME/DIV setting that results in a high enough digitizing rate. Enveloping mode on the DS-6121A helps reduce aliasing errors.

ASYNCHRONOUS:

Lacking a regular time relationship, not related through repeating time patterns. A mode of data transmission in which the beginning of the next event is started by a signal that the previous transmission has been complete.

ATTENUATOR:

An arrangement of resistor, capacitors, etc., which introduces a known reduction of the amplitude of an electrical signal without introducing appreciable phase or frequency distortion.

BATTERY BACKUP:

A battery is used to retain the contents of save memory and set-up conditions, so when AC power is removed from the scope, the contents of memory remain intact (non-volatile).

BIT:

A binary digit, which can be either a 0 or 1. A setting of four bits is called a nibble and eight bits is called a byte. In an 8-Bit microprocessor, a byte is equivalent to a word.

BYTE:

A string of eight 8 Bits, universally used to represent one alphabetic or special character. In 8-Bit microcomputers, memory is designated in bytes and is so arranged that each addressable location store 1 byte of information or one character.

CAPTURE:

Memory is used to display incoming acquisitions from CH1 and CH2. This memory location is constantly being refreshed unless a freeze operation is executed. Waveform can be transferred out to either reference or save memory locations. Capture memory in the DS-6121/6121A is volatile when power is turned off (memory data is lost).

INTERPOLATION:

The process of finding a value of a function between two known values. Interpolation may be performed numerically or graphically.

DIGITAL SAMPLING RATE:

The rate at which the A/D conversion takes place. For example, a 5MHz sampling rate means that the analog signal is converted into a digital word once every 200ns. It is automatically determined by the sweep speed selector switch.

ENVELOPE:

Enveloping capabilities include glitch capture; allows monitoring of frequency and amplitude drift over time and prevents aliasing.

EXTERNAL CLOCK:

When a DSO is used in this mode, the analog-to-digital conversion process is synchronized to an external signal. This enables the conversions to take place at the specific instance and rate determined by the user by-passing the internal timing circuits of the DSO.

NON-VOLATILE:

(memory) memory in which information can be stored indefinitely with no power applied. ROM's and EPROM'S are examples of non-volatile memory.

ONE SHOT:

Any event or transient which only occurs one time (not repetitive). The maximum digital sampling rate of DSO is related to the amount of detail that can be obtained for a 1-shot signal.

PRE-TRIGGER:

This feature makes it possible to view the events that occurs prior to the triggering point. It is useful during troubleshooting systems because it can give clues as to why a particular disturbance is occurring (e.g. a small fluctuation in voltage levels before total failure).

PRECISION:

Precision is a measure of the repeatability of successive measurement. Also called reproducibility or repeatability.

RESOLUTION:

The ability of an instrument to discriminate between two adjacent values of quantity being measured.

ROLL MODE:

Digitizes the signal and displays the latest acquired point at the right side of screen. As new data points are acquired the original points move from right to left. The display appears much like a strip chart recorder (in this mode sampling rate of DSO is slowed down to view long term variations).

RAM:

(Random Access Memory) — Memory which provides immediate access to any information in storage. RAM in microcomputers is in the form of an integrated circuit which provides the microcomputer with quick-access volatile memory. Information can be read from or written to RAM. However, when the power is turned off, all information in RAM is lost.

ROM:

(Read Only Memory) — A nonvolatile form of memory which, when once programmed, cannot be changed. ROM can be read from, but cannot be written to. If power is lost, the information in ROM remains. Also, the information in ROM cannot be changed by a computer operation. The BASIC interpreter for example in most microcomputers is in ROM.

REPETITIVE SAMPLING:

A technique that takes successive samples of a recurring waveform, and uses these points to reconstruct the original waveform, thereby, giving the DSO a higher effective bandwidth (on repetitive signals only). Also see questions and answers on equivalent sampling technique used in the DS-6121/6121A.

REFERENCE MEMORY:

A memory location which stores waveforms for display. A waveform is transferred into reference memory from either capture or save memory. Reference memory is a volatile, when power is turned off all data is lost.

SAVE MEMORY:

Non-volatile storage memory. Waveforms can be transferred into and out of this location from capture and reference memory.

SYNCHRONOUS COMMUNICATION:

A method of transferring serial binary data between computer systems or between a computer system and a peripheral device; binary data is transmitted at a fixed rate, with the transmitter and receiver synchronized. Synchronization characters are located at the beginning of each message or block of data to synchronize the flow.

TRANSIENT:

A phenomenon, such as damped oscillations or a voltage or current surge, that occurs in an electrical system following a sudden change in the dynamic conditions of the system and that it usually relatively short-lived. A transient may be caused by the application of an impulse voltage or current to the system or by the application or removal of a driving force. The nature of the transient is a function of the system itself but the magnitude depends on the magnitude of the impulse or the driving force.

WORD:

The largest group of bits which can be treated as a unit by the CPU and occupies one storage location in memory. In an 8-bit microcomputer, a word is equivalent to a byte.

MEMO

Section 4 GP-IB Interface (Option)

4-1 GENERAL

By inserting the Interface Unit DS-502 into DS-6121/DS-6121A (hereafter called the instrument), control of such function as writing, reading, etc. is enabled by using an external controller.

Its specification is in compliance with IEEE std. 488-1978, electronically and mechanically.

4-1-1 Specifications of GP-IB

Input/Output signal

Input	TTL level	Active low
Output	TTL level	Active low

Up to 15 instruments are connectable in one system

<Note> (The number of instruments connected) \times 2 m should not exceed 20 m.

The length of the cable

The total length of the cable, 2 m \times (the number of connected instrument) should not exceed 20 m.

Caution

This instrument is to be used preferably under conditions which are relatively good electrically and physically.

Figure 4-1. Installation of the DS-502

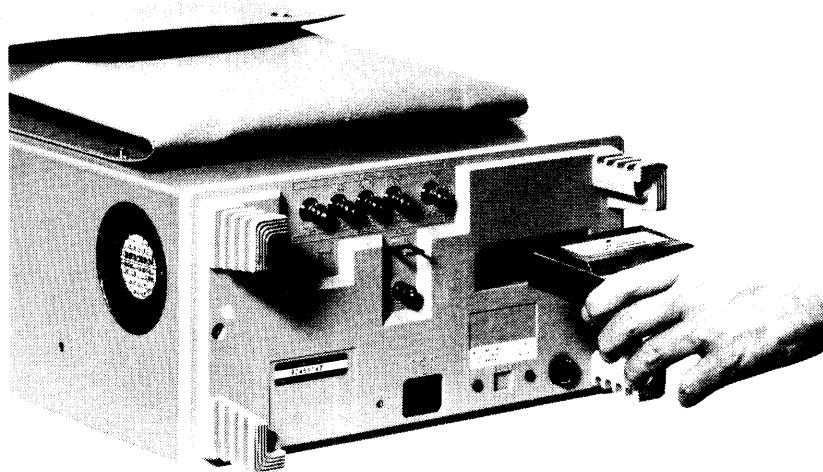

4-1-2 Construction

The instrument can be connected to the following equipment.

1. Personal computers, minicomputers, etc. equipped with GP-IB.
2. Plotter *1 IWATSU format
(SR-6602, SR-6620, SR-6625)
HP-GL format
(SR-6620H, HP-7440A, 7470A, 7475A)

*1 The plotters are connectable without external controller.

4-1-3 Function Subsets

Subsets functions of the instrument are shown in the Table 4-1-3.

Table 4-1-3.

Subset	Interface Function	Description
SH 1	Source Handshake	Complete capability
AH 1	Acceptor Handshake	Complete capability
T6	Talker	Basic talker, Serial poll, Unaddress if MLA, Talk only mode
L4	Listener	Basic listener, Unaddress if MTA
SR 1	Service Request	Complete capability
RL 1	Remote Local	Complete capability
PP 0	Parallel Poll	No capability
DC 1	Device Clear	Complete capability
CO	Controller	No capability
TEO	Talker Address Extension	No capability
LEO	Listener Address Extension	No capability

4-1-4 Signal Line and the Number of Connector Pin

Shown in Table 4-1-4 is the signal line of input/output signals and the number of connector pin, and in Figure 4-1-4 the number and position of the connector pin.

Table 4-1-4. Signal Line and the Number of Connector Pin

Connector Pin Number	Signal Line	Purpose for Use
1	DIO 1	Input/output of data (LSB)
2	DIO 2	
3	DIO 3	
4	DIO 4	
5	EOI	Shows the end of transmitted data
6	DAV	Used for handshaking
7	NRFD	
8	NDAC	
9	IFC	Interface Clear Signal from the System Controller
10	SQR	Service Request line from each instrument
11	ATN	Shows command mode or data mode of DIO line
12	GND	GND
13	DIO 5	Input/output of data
14	DIO 6	
15	DIO 7	
16	DIO 8	
17	REN	Switch of Remote/Local
18	GND	GND
	GND	
24	GND	

Signal Line

Signal line in Table 4-1-4 is explained in the following:

1. Data line
 DIO 1 to DIO 8
 Used for data input/output.
2. Handshake line
 DAV (DATA VALID)
 NRFD (NOT READY FOR DATA)
 NDAC (NOT DATA ACCEPTED)
 These three signals are controlled automatically inside, and will not be explained here.
3. Interface Control Line
 ATN (ATTENTION)
 A signal to distinguish a message from controller.
 1 indicates an interface message, and 2 indicates a device message.

- IFC (INTERFACE CLEAR)
 Transmitted from the controller, and put TALKER and LISTENER in the idle state.
- SRQ (SERVICE REQUEST)
 Interruption signal to the controller.
- REN (REMOTE ENABLE)
 Transmitted from the controller, and together with other messages, used for switching of REMOTE/LOCAL.
 1: Indicates that REMOTE/LOCAL control is enabled by an interface message.
 2: Switches the mode to LOCAL.
- EOI (END OR IDENTIFY)
 When the instrument is the TALKER, EOI will be outputted together with the final byte.

Figure 4-1-4. GP-IB Connector and Pin Assignments

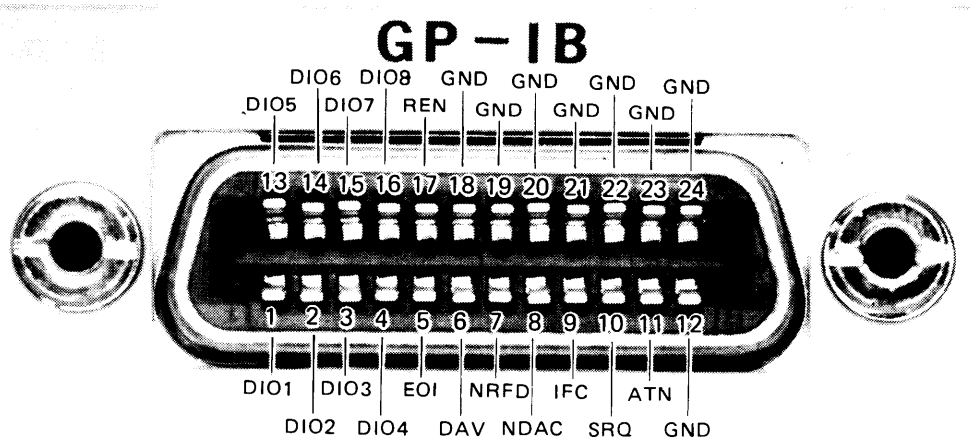

4-2 ADDRESSING

Turning switches on the GP-IB unit DS-502, ADDRESS, DELIMITER, and TALK ONLY is set.

4-2-1 ADDRESS Setting (2⁰, 2¹, 2², 2³, 2⁴)

Address is set using 5-bit switches of 5 to 1. Setting is done in binary, and 5 to 1 have weights of 2⁴ to 2⁰, respectively.

Caution

Address number 31, that is, setting all of the five bits to 1, is not allowed in specifications of the instrument. This is because setting all bits to 1 corresponds to the unlisten or untalk state.

Table 4-2-1. Address Setting

Address No.	54321
0	00000
1	00001
2	00010
3	00011
4	00100
5	00101
5	5
25	11001
26	11010
27	11011
28	11100
29	11101
30	11110

4-2-2 DELIMITER Setting

Using D1 and D2, the kind of delimiter upon data input/output is set.

Table 4-2-2. Delimiter Setting

D2	D1	Delimiter
0	0	LF
0	1	LF
1	0	CR
1	1	CR LF

LF : Line Feed
CR : Carriage Return

4-2-3 TALK ONLY Setting

By setting one of the 1 to 5 switches at ON and conducting key operations on the front panel (see 3-7-9). TALKONLY mode is activated. This mode is used for taking hardcopies of the display on the screen with IWATSU format plotter (SR-6602, SR-6620, SR-6625) and with HP-GL format plotter (SR-6620H, HP-7440A, HP-7470A, HP7475A) without the controller.

Note on EOI

When the instrument is the TALKER, EOI is outputted without fail. When the instrument is the LISTENER, disregards EIO.

Figure 4-2. Instrument Address Switch

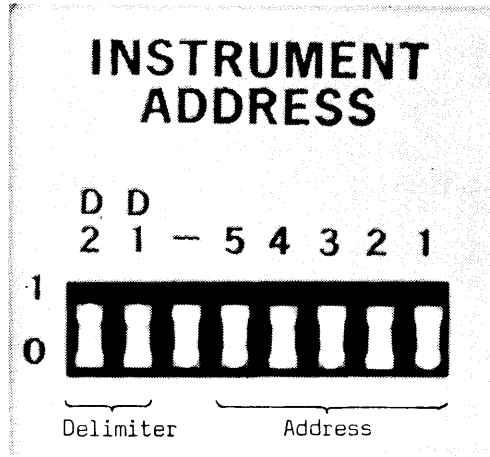

Address

- | | |
|---------------------------|--|
| 1: Address (2^0) = 1 | } The sum of the numerical values corresponding to the relevant switches which are in 1 (ON) position will become the address of the instrument. |
| 2: Address (2^1) = 2 | |
| 3: Address (2^2) = 4 | |
| 4: Address (2^3) = 8 | |
| 5: Address (2^4) = 16 | |

The setting in this figure is 01010, and the address number is 10.

Delimiter

The setting in this figure is CR LF.

4-3 FUNCTION

4-3-1 Outline

The instrument has the following functions.

a. Data transmission

(a) Data Read-out

The waveform data can be outputted.

(b) Data Writing

The waveform data can be inputted in special regions.

b. Panel operations

The panel operations can be done separately or collectively. Information on panel setting is outputted separately or collectively.

c. Status Output

Service Request is outputted when the operation of the instrument is completed or an error occurred.

The status byte which shows the cause of Service Request is outputted with serial poll by an external controller.

d. Control message responses

Refer to Table 4-3-5 (page on 4 - 9).

4-3-2 Data Transmission

a. This function are classified into the following four kinds:

- ① Read-out of displayed waveform data
- ② Writing of displayed waveform data

b. The transferred contents to be the object of transfer are:

Displayed waveform data: Waveform data (main information), waveform auxiliary information.

c. Number of data for waveform data

• Norm mode

CAPTURE memory captures 2048 data in any sweep range and transfers these to external device.

In the range slower than 10 $\mu\text{S}/\text{div}$ (5 $\mu\text{S}/\text{div}$ in 1 channel operation), screen and data length may match but in the range faster than 5 $\mu\text{S}/\text{div}$ (2 $\mu\text{S}/\text{div}$ in 1 channel operation), they may not match. For example, in 5 $\mu\text{S}/\text{div}$, the first 1024 data may correspond with the screen.

In other words, in the range faster than 10 $\mu\text{S}/\text{div}$ (40 MHz clock in the one faster than 5 $\mu\text{S}/\text{div}$ for the 1 channel operation), sampling is always made in 20 MHz clock, 2048 data are captured and they are transmitted to external devices.

<Note> All the storage modes except for equivalent sampling (EQU-SAMPLING) mode and envelope mode.

• Envelope mode (DS-6121A)

CAPTURE memory captures 2048 data in any sweep range and transfers these to external device.

In the range slower than 50 $\mu\text{S}/\text{div}$, screen and data length may match but in the range faster than 20 $\mu\text{S}/\text{div}$, they may not match. For example, in 20 $\mu\text{S}/\text{div}$, the first 819 data may correspond with the screen.

In other words, in the range faster than 50 $\mu\text{S}/\text{div}$ of MAX and MIN data is alternately made in 4 MHz clock, 2048 data are captured and they are transmitted to external devices.

d. Waveform auxiliary information

The waveform auxiliary information is used in the following cases.

① When DS-6121/DS-6121A is connected to other equipments made by Iwatsu (SM-2700, etc.): These external equipments will use the waveform auxiliary information for processing.

② When the user wants to know the sampling block and vertical axis sensitivity of the waveform data:

The sampling block or vertical axis sensitivity cannot be read out from SET-UP data. As mentioned before, this is because SET-UP data are external codes and not open to users.

The contents transmitted and their order are as shown in the following table.

Order	Contents	Format
1	Number of waveform auxiliary information	AA) 6)
2	Type of binary data	AB) 2)
3	Data of length	AC) 2)
4	Δx	AD) 2.5E-6)
5	Y-FULL SCALE	AE) 0.1024)
6	DELAY value	*1 AF) 0)

*1 Identification code

Two alphabet letters: Identification code
) : Delimiter

(Description)

- Number of waveform auxiliary information
For DS-6121/DS-6121A, they are six and the number is fixed.
- Type of binary data
Binary data of waveform data (main information).
0 : Binary transmit mode ineffective (ASCII)
2 : 2 bytes/1 data
- Data length
The length of waveform data.rm data.
1 : 1024
2 : 2048
- Δx
This is a sampling clock cycle when the waveform is captured.
The display is with exponential format and the unit is [sec.].
Example: 2.5E-6 → Sampling cycle of 2.5 μ S
(Equivalent to 0.5 mS/div)
- Y-FULL SCALE
This is the full-scale value of vertical (Y) axis.
The unit for this value is volt (V).
Example: 0.102E+0 → 0.1024V full-scale (equivalent to 10 mV/div)
- DELAY value
Fixs to 0.

Example of reading out of waveform auxiliary information
Example: Reading out of waveform auxiliary information for CH 1
JX M10, 7

You cannot write waveform auxiliary information. In other words, IX M10, 7 is impossible.

e. Input and output format of waveform data

In type of binary data, the data is transferred with the order of at first UPPER BYTE, then LOWER BYTE.

In type of ASCII, 1 LSB = 256.

LEVEL	TYPE OF BINARY DATA		ASCII
	UPPER BYTE	LOWER BYTE	
+FULL SCALE	01111111	00000000	+32512
+FULL SCALE-1LSB	01111110	00000000	+32256
⋮	⋮	⋮	⋮
+1LSB	00000001	00000000	+ 256
0	00000000	00000000	0
-1LSB	11111111	00000000	- 256
⋮	⋮	⋮	⋮
-FULL SCALE+1LSB	10000001	00000000	-32512
-FULL SCALE	10000000	00000000	-32768

Voltage can be obtained from the formula of

$$\frac{\text{Output Waveform Data}}{65536} \times \text{Y-FULL scale}$$

or alternatively from

$$\frac{\text{Output Waveform Data}/256}{.25} \times \text{VOLTS/DIV setting}$$

4-3-3 Panel Operations

Individual panel operations can be performed. The operation procedure is the same as the manual operation procedure. The lamps (LEDs) on the panel in the individual operation mode operate in the same way as manual operation.

a. The following individual operations can be performed:

- Measuring condition setting
- Display
- Output
- Processing

b. Restrictions

The following are excepted from individual operations:

- Power ON/OFF
- A INTENSITY
- CHARACTER INTENSITY
- ENHANCE
- BEAM FIND
- FOCUS
- ASTIG
- SCALE
- TRACE ROTATION
- NO GO judgement in GO/NOGO operation

Caution

Collective setting (writing) or read-out of panel operations can be performed by following the item 4-3-2.

4-3-4 Status Output

This function is to inform the state of internal operation such as error occurrence and operation completion to the external controller by SRQ signal and status byte.

SRQ and STATUS Occurrence

1. Cause of SRQ Occurrence

- Causes of SRQ occurrence can be classified into the following two:
- Occurrence of error
 - Normal completion of operation

- a) Occurrence of error
 - In receipt of undefined GP-IB command
 - Parameter error of GP-IB
 - When GP-IB command is non-executable
 - Too long word-length of GP-IB command
- b) Normal completion of operation
 - Completion of pause of averaging
 - Completion of capture of observed signal
 - NOGO judgement in GO/NOGO mode

2. STATUS BYTE

The outline of details of causes of SRQ occurrence described in 1 above can be known if the external controller reads the STATUS BYTE by serial polling.

Content of STATUS BYTE is described in the following:

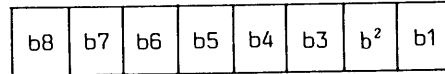

- b8: not used
- b7: 0 no request 1 requested
- b6: 0 normal 1 error
- b5: undefined GP-IB command was received
- b4: parameter error in GP-IB command
- b3: GP-IB command is not executable
- b1: Too long word-length of GP-IB command

→ Relevant GP-IB command will be ignored.

Binary								Deci- mal	Remarks
b1	b2	b3	b4	b5	b6	b7	b8		
0	1	0	0	0	0	0	0	64	Completion of wave- form capture, Completion or stop of averaging.
0	1	0	0	0	0	1	0	66	NO GO judgement

3. Clearing of SRQ and STATUS BYTE

- a) Clearing of SRQ
 - Serial poll sequence was conducted when DCL, and SDC was received
- b) Clearing of STATUS BYTE
 - When DCL, and SDC was received
 - When the relevant cause disappeared

4-3-5 Control Message Responses

The following table shows the details of control messages.

Table 4-3-5. Details of Control Messages

Message	Response from the Instrument
IFC	Initialize the interface, and LISTENER and TALKER functions are set in idle state.
REN	Remote operation is enabled when MLA was simultaneously transmitted.
ATN	Receives the data on a bus as an interface message and responds to it.
EOI	Used as an end signal of a record for data transmission.
DCL, SDC	Initialization of instrument and clearing of SQR.
SPE, SPD	Conducts serial poll operation and transmit the status byte.
UNL	Clears LISTENER mode and interrupts data transmission. Operation is resumed when LISTENER mode is specified again.
UNT	Clears TALKER mode and interrupts data transmission. Operation is resumed when TALKER mode is specified again.
MLA	If the current mode is TALKER, this is cleared and switched to LISTNER mode. If it is during data transfer, the transmission terminates compulsorily.
MTA	If the current mode is LISTNER, this is cleared and switched to TALKER mode. If it is during data transfer, the signal receiving is terminated compulsorily.
DAV, NRFD, NDAC	Data is transmitted by three-line handshaking.
GTL	The same operation is conducted as when the panel key was pressed. Clears the lock of panel key and place the system in LOCAL mode.
LLD	Allows return-to-LOCAL only under program control.

4-4 DETAILS OF GP-IB COMMANDS

4-4-1 Waveform Data Read Command

Function: To read data from files to the GP-IB.

The data read out by this command are:

- Setup data
- Waveform data
- Auxiliary information of waveform data

Format

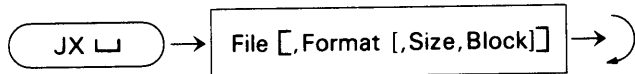

Parameters

- a. File
 - Input buffer memory file M10, M11
 - Current setup file S
- b. Format
 - Data record format for data transfer
 - Set value

Format	Code	Data Expression	No. of Bytes for a String	Record Discriminator
1	ASCII	Integer	8 bytes max.	LF, CR or CR LF
3	Binary	1 word	2 bytes	2 bytes
7	ASCII	Combination	Variable	LF, CR or CR LF

<Note> Combination in the data expression column means a combination of an integer, real number, floating decimal point, and alphanumerics.

- c. Size

Parameter that specifies the size of main information to be read out from a file in units 1k words

Set values: 1 or 2 1: 1k words
 2: 2k words

- d. Block

Transfer start block number

Parameter that specifies a file block number to start reading main information

 - Set value 0 or 1

<Note> If block 1 is specified, the preceding parameter's <size> will always be 1.
Block size: 1 word
Block numbers 0 and 1 to be assigned every kilo-bytes, starting with the smallest address number.

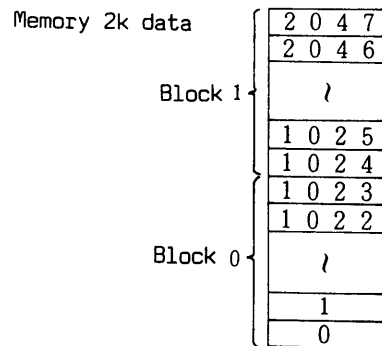

Caution

The following three combinations of size and block are allowed.

Size	Block
1	0
1	1
2	0

JX commands

The following seven types are allowed concerning "JX" command.

- (1) Auxiliary information on the data stored in buffer memory 1 is sent. Format 7 is specified.

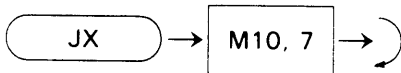

- (2) Auxiliary information on the data stored in buffer memory 2 is sent. Format 7 is specified.

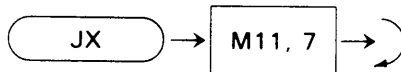

- (3) The data stored in buffer memory 1 is transferred in binary code.

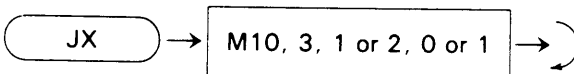

- (4) The data stored in buffer memory 2 is transferred in binary code.

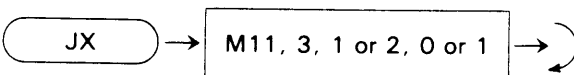

- (5) The data stored in buffer memory 1 is transferred in ASCII code.

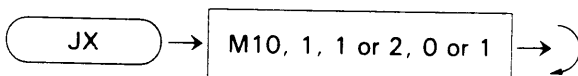

- (6) The data stored in buffer memory 2 is transferred in ASCII code.

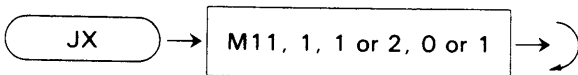

4-4-2 Waveform Data Write Command

Function: To write data from the GP-IB to files.
The data written by this command are:
Setup data
Waveform data

Format

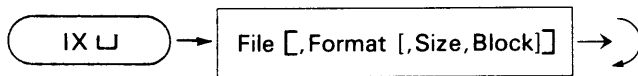

Parameters

- a. File
- Input buffer memory file M10 (CH 1), M11 (CH 2)
 - Current setup file S
- b. Format
- Data record format for data transfer
 - Set value

<Format>	Code	Data Expression	No. of Bytes for a String	Record Discriminator
1	ASCII	Integer	8 bytes max.	LF, CR or CR LF
3	Binary	1 word	2 bytes	2 bytes
7	ASCII	Combination	Variable	LF, CR or CR LF

<Note> Combination in the data expression column means a combination of an integer, reel number, floating decimal point, and alphanumerics.

- c. Size
Parameter that specifies the size of main information to be read out from a file in units 1k words
Set values: 1 or 2 1: 1k words
 2: 2k words
- d. Block
Transfer start block number
Parameter that specifies a file block number to start reading main information
• Set value 0 or 1
<Note> If block 1 is specified, the preceding parameter's <size> will always be 1.

Caution

No IX for auxiliary information.

IX commands

The following five types are allowed concerning "IX" command.

- (1) The data stored in buffer memory 1 is transferred in binary code.

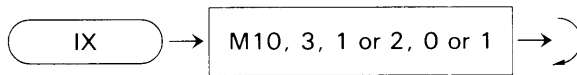

- (2) The data stored in buffer memory 2 is transferred in binary code.

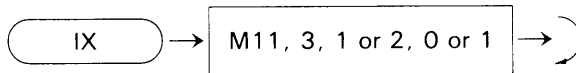

- (3) The data stored in buffer memory 1 is transferred in ASCII code.

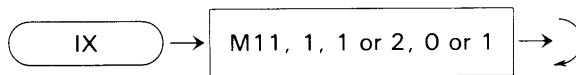

- (4) The data stored in buffer memory 2 is transferred in ASCII code.

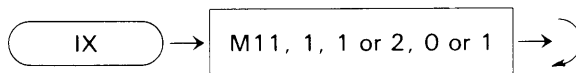

Corresponding List (panel key to GP-IB command)

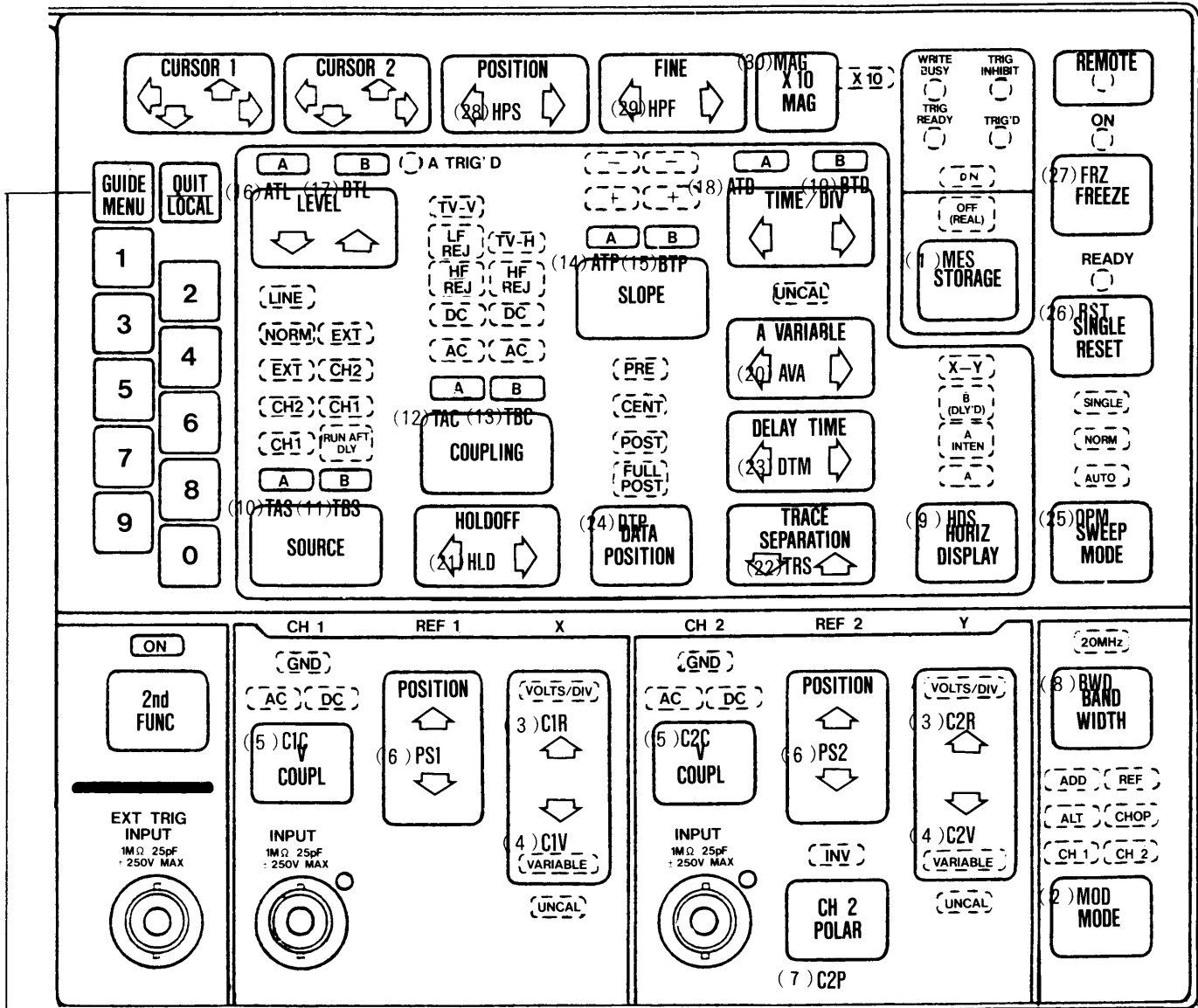

<Note> GP-IB commands are shown in red.

- Cursor Measurement (31) CUR
- SETUP RECALL/SAVE (32) STU
- WAVEFORM RECALL (33) WFM 1
- SAVE WFM 2
- MOVE WFM 3
- CURVE INTERPOLATION (34) IPL
- CALCULATION (35) CAL
- GO/NO JUDGEMENT
- a. Cursor-Cursor (36) YNC
- b. Waveform-Cursor YNW
- AVERAGING (37) AVR
- ENVELOPE (DS-6121A) (38) ENV
- EQU-SAMPLING (39) EQS

Commands List

Commands	Contents	Parameter (1)
(1) MES	Measuring mode	0: STORAGE OFF 1: STORAGE ON
(2) MOD	Vertical mode	1: CH 1 2: CH 2 3: ALT 4: CHOP 5: ADD 6: CH 1 & CH 2 7: CH 1 CH 2 & REF
(3) C1R C2R	CH 1 VOLTS/DIV CH 2 VOLTS/DIV	1: 1 mV 2: 2 mV 3: 5 mV 4: 10 mV 5: 20 mV 6: 50 mV 7: 0.1 V 8: 0.2 V 9: 0.5 V 10: 1 V 11: 2 V 12: 5 V
(4) C1V C2V	CH 1 VARIABLE CH 2 VARIABLE	$0 \leq \sim \leq 255$
(5) C1C C2C	CH 1 COUPLING CH 2 COUPLING	0: AC 1: GND 2: DC
(6) PS 1 PS 2	CH 1 Vert. POSITION CH 2 Vert. POSITION	$-1024 \leq \sim \leq +1023$
(7) C2P	CH 2 POLARITY	0: NORMAL 1: INVERT
(8) BWD	BANDWIDTH	0: OFF 1: ON (20MHz)
(9) HDS	HORIZ DISPLAY	1: A 2: A INTEN 3: A INTEN & B (BLY'D) 4: B (BLY'D) 5: X-Y
(10) TAS	A TRIGGER SOURCE	1: CH 1 2: CH 2 3: EXT 4: NORM 5: LINE
(11) TBS	B TRIGGER SOURCE	0: RUN AFTER DELAY 1: CH 1 2: CH 2 3: EXT
(12) TAC	A TRIGGER COUPLING	1: AC 2: DC 3: HF REJ 4: LF REJ 5: TV-V
(13) TBC	B TRIGGER COUPLING	1: AC 2: DC 3: HF REJ
(14) ATP	A TRIGGER SLOPE	0: + 1: --
(15) BTP	B TRIGGER SLOPE	0: + 1: --
(16) ATL	A TRIGGER LEVEL	$-100 \leq \sim \leq +100$
(17) BTL	B TRIGGER LEVEL	$-100 \leq \sim \leq +100$
(18) ATD	A TIME/DIV	0: EXT CLOCK 1: 10 s 2: 5 s 3: 2 s 4: 1 s 5: 0.5 s 6: 0.2 s 7: 0.1 s 8: 50 ms 9: 20 ms 10: 10 ms 11: 5 ms 12: 2 ms 13: 1 ms 14: 0.5 ms 15: 0.2 ms 16: 0.1 ms 17: 50 μs 18: 0.5 ms 19: 0.2 ms 20: 0.1 ms 21: 50 μs 22: 20 μs 23: 10 μs 24: 5 μs 25: 2 μs 26: 1 μs 27: 0.5 μs 28: 0.2 μs 29: 0.1 μs 30: 20 ns 31: 10 ns 32: 5 ns 33: 2 ns 34: 1 ns
(19) BTD	B TIME/DIV	7: 0.1 s 8: 50 ms 9: 20 ms 10: 10 ms 11: 5 ms 12: 2 ms 13: 1 ms 14: 0.5 ms 15: 0.2 ms 16: 0.1 ms 17: 50 μs 18: 20 μs 19: 10 μs 20: 5 μs 21: 2 μs 22: 1 μs 23: 0.5 μs 24: 0.2 μs 25: 0.1 μs 26: 50 ns 27: 20 ns

Commands	Contents	Parameter (1)	Parameter (2)	Parameter (3)
(20) AVA	A VARIABLE	$0 \leq \sim \leq 255$		
(21) HLD	HOLDOFF	$0 \leq \sim \leq 200$		
(22) TRS	TRACE SEPARATION	$0 \leq \sim \leq 255$		
(23) DTM	DELAY TIME	$0.20 \leq \sim \leq 10.20$		
(24) DTP	DATA POSITION	0: FULL POST 1: POST 2: CENTER 3: PRE		
(25) OPM	OPERATION mode	1: AUTO 2: NORM 3: SINGLE		
(26) RST	SINGLE RESET	No parameter		
(27) FRZ	FREEZE	0: OFF 1: ON		
(28) HPS	HORIZONTAL POSITION	$-128 \leq \sim \leq +127$		
(29) HPF	FINE (HOR POSITION)	$-8 \leq \sim \leq +7$		
(30) MAG	MAG X10	0: OFF 1: ON		
(31) CUR	CURSOR measurement	0: OFF 1: ΔVOLTS 2: ΔTIME 3: ΔVOLTS ON WAVEFORM	ΔVOLTS $-512 \leq \sim \leq +511$ ΔTIME or ΔVOLTS ON WAVEFORM $0 \leq \sim \leq 2048$	ΔVOLTS $-512 \leq \sim \leq +511$ ΔTIME or ΔVOLTS ON WAVEFORM $0 \leq \sim \leq 2048$
(32) STU	SETUP RECALL/SAVE	1: RECALL 2: SAVE	1: SETUP MEM 1 2: SETUP MEM 2 3: SETUP MEM 3 4: SETUP MEM 4 5: SETUP (LAST DATA) 6: SETUP (POWER OFF) 7: DEFAULT	
(33) a. WFM 1	WAVEFORM RECALL	1: WFM MEM 1 2: WFM MEM 2 3: WFM MEM 3 4: WFM MEM 4	1: REF 1 2: REF 2	
b. WFM 2	WAVEFORM SAVE	1: CH 1 2: CH 2 3: REF 1 4: REF 2	1: WFM MEM 1 2: WFM MEM 2 3: WFM MEM 3 4: WFM MEM 4	
c. WFM 3	WAVEFORM MOVE	1: CH 1 → REF 1 2: CH 2 → REF 2 3: CH 1 → REF 1 CH 2 → REF 2 4: CH 1 → REF 2 5: CH 2 → REF 1 6: CH 1 → REF 2 CH 2 → REF 1		
(34) IPL	CURVE INTERPOLATION	0: OFF 1: ON		
(35) CAL	CALCULATION +, -, X	0: OFF 1: ON	1: + 2: - 3: X	

Commands	Contents	Parameter (1)	Parameter (2, 3)	Parameter (4, 5)
(36) a. YNC	GO/NO Cur. to Cur.	0: OFF 1: IN-RANGE 2: OUT-RANGE	$-512 \leq \sim \leq +511$	$0 \leq \sim \leq +2047$

Commands	Contents	Parameter (1)	Parameter (2, 3)	Parameter (4)
b. YNW	GO/NO Cur. to Wave	0: OFF 1: IN-RANGE 2: OUT-RANGE	$0 \leq \sim \leq 2047$	1: WFM MEM 1 2: WFM MEM 2 3: WFM MEM 3 4: WFM MEM 4
		Parameter (5)	Parameter (6)	Parameter (7)
		$-256 \leq \sim \leq +255$	1: WFM MEM 1 2: WFM MEM 2 3: WFM MEM 3 4: WFM MEM 4	$-256 \leq \sim \leq +255$

Commands	Contents	Parameter (1)
(37) AVR	AVERAGING	0: OFF 1: 2 2: 4 3: 8 4: 16 5: 32 6: 64 7: 128 8: 256
(38) ENV (DS-6121A)	ENVELOPE	0: OFF 1: with MAX HOLD 2: without MAX HOLD
(39) EQS	EQUIVALENT SAMPLING	0: OFF 1: ON

4-4-3 Individual Panel Operation

Caution

In case of setting parameter to 0, the sign (-) should be omitted. "-0" setting is ineffective.

(1) MEASURING MODE

Format

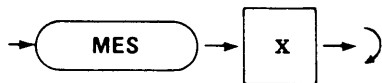

Parameter

X	Storage on or off
0	OFF (Real)
1	ON (STORAGE)

(2) VERTICAL MODE

Format

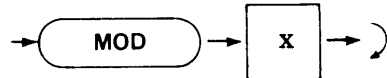

Parameter

X	Mode
1	CH1
2	CH2
3	ALT
4	CHOP
5	ADD
6	CH1 & CH2
7	CH1CH2 & REF

(3) VOLTS/DIV

Format

CH1

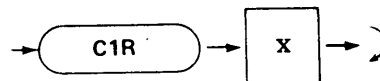

CH2

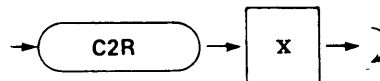

Parameter

X	VOLTS/DIV
1	1 mV
2	2 mV
3	5 mV
4	10 mV
5	20 mV
6	50 mV
7	0.1 V
8	0.2 V
9	0.5 V
10	1 V
11	2 V
12	5 V

(4) VARIABLE

Format

CH1

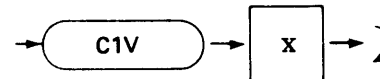

CH2

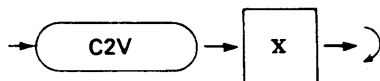

Parameter $0 \leq X \leq 255$

(5) COUPLING

Format

CH1

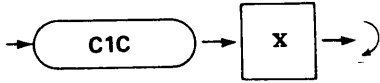

CH2

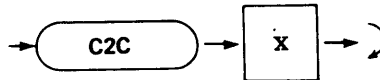

Parameter

X	Coupling
0	AC
1	GND
2	DC

(8) BANDWIDTH

Format

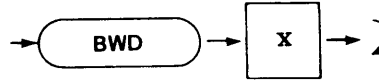

Parameter

X	Bandwidth
0	OFF
1	ON (20 MHz)

(9) HORIZ DISPLAY

Format

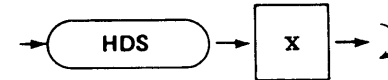

Parameter

X	Horiz Display
1	A
2	A INTEN
3	A INT & B (DLY'D)
4	B (DLY'D)
5	X-Y

(6) Vertical POSITION

Format

CH1

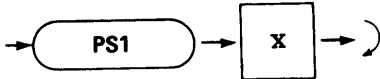

CH2

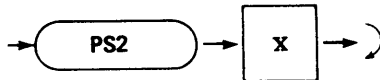

Parameter $-1024 \leq x \leq +1023$

(7) CH2 POLARITY

Format

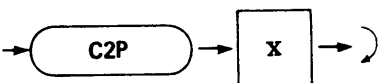

Parameter

X	Normal or Invert
0	NORMAL
1	INVERT

(10) A TRIGGER SOURCE

Format

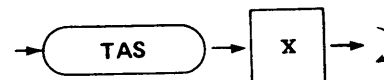

Parameter

X	A Trigger Slope
1	CH1
2	CH2
3	EXT
4	NORM
5	LINE

(11) B TRIGGER SOURCE

Format

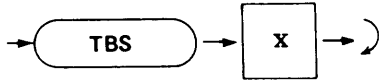

Parameter

X	B Source
0	RUN AFTER DELAY
1	*1 CH1
2	*1 CH2
3	*1 EXT

*1 Setting B TRIGGER to CH1, CH2 or EXT and A TRIGGER SOURCE to TV-V, B TRIGGER SOURCE will be set to TV-H.

(12) A TRIGGER COUPLING

Format

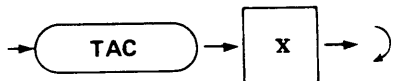

Parameter

X	A Trigger Source
1	AC
2	DC
3	HF REJ
4	LF REJ
5	TV - V

(13) B TRIGGER COUPLING

Format

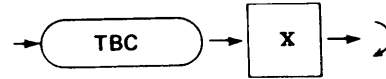

Parameter

X	B Trigger Coupling
1	AC
2	DC
3	HF REJ

(14) A TRIGGER SLOPE

Format

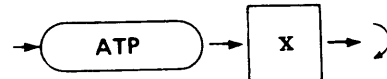

Parameter

X	A Trigger Slope
0	+
1	-

(15) B TRIGGER SLOPE

Format

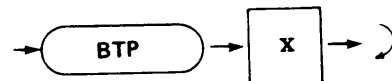

Parameter

X	B Trigger Slope
0	+
1	-

(16) A TRIGGER LEVEL

Format

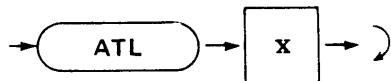

Parameter $-100 \leq X \leq +100$

(17) B TRIGGER LEVEL

Format

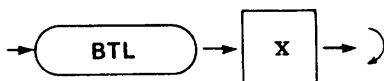

Parameter $-100 \leq X \leq +100$

(18) A TIME/DIV

Format

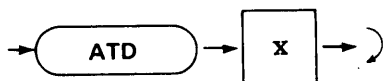

Parameter

X	TIME/DIV	X	TIME/DIV
0	EXT CLOCK	14	0.5 ms
1	10 s	15	0.2 ms
2	5 s	16	0.1 ms
3	2 s	17	50 μs
4	1 s	18	20 μs
5	0.5 s	19	10 μs
6	0.2 s	20	5 μs
7	0.1 s	21	2 μs
8	50 ms	22	1 μs
9	20 ms	23	0.5 μs
10	10 ms	24	0.2 μs
11	5 ms	25	0.1 μs
12	2 ms	26	50 ns
13	1 ms	27	20 ns

(19) B TIME/DIV

Format

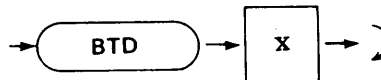

Parameter

X	TIME/DIV	X	TIME/DIV
7	0.1 s	18	20 μs
8	50 ms	19	10 μs
9	20 ms	20	5 μs
10	10 ms	21	2 μs
11	5 ms	22	1 μs
12	2 ms	23	0.5 s
13	1 ms	24	0.2 s
14	0.5 ms	25	0.1 s
15	0.2 ms	26	50 ns
16	0.1 ms	27	20 ns
17	50 μs		

(20) A VARIABLE

Format

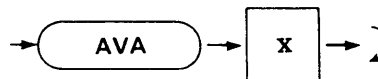

Parameter $0 \leq X \leq 255$

(21) HOLDOFF

Format

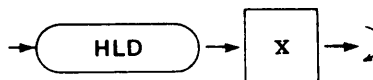

Parameter $0 \leq X \leq 200$

(22) TRACE SEPARATION

Format

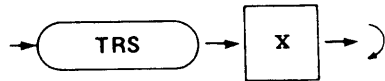

Parameter $0 \leq X \leq 255$

Caution

TRS command "Value" does not necessarily coincide with the separation on the CRT screen because of the dead space in its initial portion, as shown in the following.

(23) DELAY TIME

Format

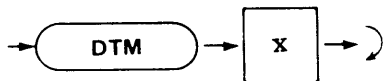

Parameter $0.20 \leq X \leq 10.20$

Caution

DTM command "Value" is effective to 2nd decimal place. If it contains the third decimal place, DLY command will be ignored.

(24) DATA POSITION

Format

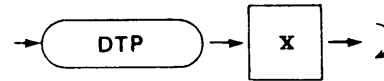

Parameter

X	Data Position
0	FULL POST
1	POST
2	CENTER
3	PRE

(25) OPERATION MODE

Format

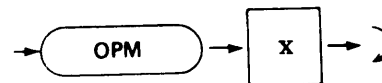

Parameter

X	Operation Mode
1	AUTO
2	NORM
3	SINGLE

(26) SINGLE RESET

Format

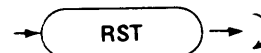

(27) FREEZE

Format

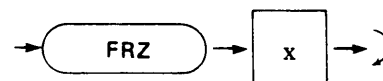

Parameter

X	On or Off
0	OFF
1	ON

(28) HORIZONTAL POSITION

Format

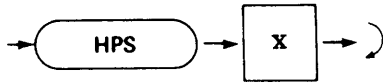

Parameter $-128 \leq X \leq +127$

Caution

Horizontal Position register consists of 12 bits. Indicate the upper 8 bits by HPS and the lower 4 bits by HPF.

HPS

(29) FINE (HORIZONTAL POSITION)

Format

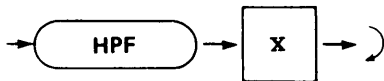

Parameter $-8 \leq X \leq +7$

(30) MAG x 10

Format

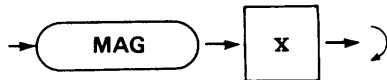

Parameter

X	Mag x 10 On or Off
0	OFF
1	ON

(31) CURSOR MEASUREMENT

Format

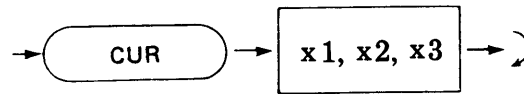

Parameter

X1	Voltage or Time
0	OFF
1	ΔVOLTS
2	ΔTIME
3	ΔVOLTS ON WAVEFORM

X2, X3

ΔVOLTS	ΔTIME or ΔVOLTS on WAVEFORM
-512 to +511	0 to 2048

(32) SETUP RECALL/SAVE

Format

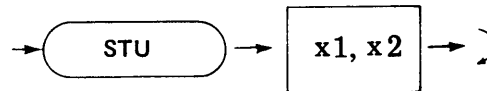

Parameter

X1	Recall or Save
1	RECALL
2	SAVE

X2	From or to File Name
1	SETUP MEM 1
2	SETUP MEM 2
3	SETUP MEM 3
4	SETUP MEM 4
5	SETUP (LAST DATA)
6	SETUP (POWER OFF)
7	DEFAULT

(33) WAVEFORM RECALL/SAVE

a. RECALL

Format

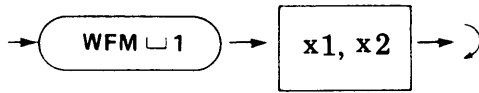

Parameter

X1	From File Name
1	WFM MEM 1
2	WFM MEM 2
3	WFM MEM 3
4	WFM MEM 4

X2	To File Name
1	REF1
2	REF2

b. SAVE

Format

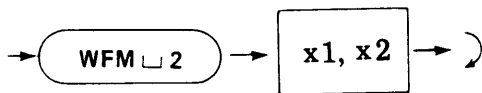

Parameter

X1	From File Name
1	CH1
2	CH2
3	REF1
4	REF2

X2	To File Name
1	WFM MEM 1
2	WFM MEM 2
3	WFM MEM 3
4	WFM MEM 4

c. MOVE

Format

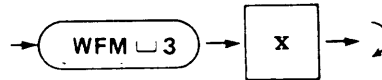

Parameter

X	Content of MOVE
1	CH1 → REF1
2	CH2 → REF2
3	CH1 → REF 1 CH2 → REF2
4	CH1 → REF2
5	CH2 → REF1
6	CH1 → REF2 CH2 → REF1

(34) CURVE INTERPOLATION

Format

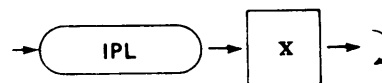

Parameter

X	On or Off
0	OFF
1	ON

(35) CALCULATION (+, -, X)

Format

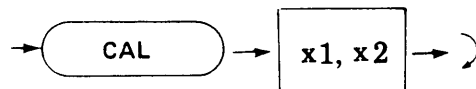

Parameter

X1	On or Off
0	OFF
1	ON

X2	Type of calculation
1	+
2	-
3	X

(36) GO/NO GO Judgement

a. Cursor to Cursor

Format

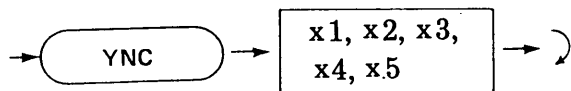

Parameter

X1

X1	Range Selection
0	OFF
1	IN-RANGE
2	OUT-RANGE

X2, X3 V cur I and II adr
 $-512 \leq X2, X3 \leq +511$

X4, X5 H cur I and II adrs
 $0 \leq X4, X5 \leq +2047$

b. Cursor to Waveform

Format

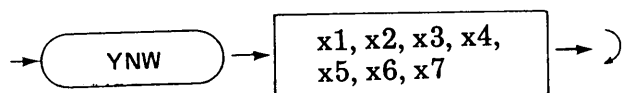

CAUTION

The external GO/NOGO judgement through the interface is available only with FREE IF NOGO. SRQ occurs when NOGO is judged.

Parameter

X1

X1	Range Selection
0	OFF
1	IN-RANGE
2	OUT-RANGE

X2, X3 H cur I and II adrs
 $0 \leq X2, X3 \leq 2047$

X4

X4	File Name 1
1	WFM MEM 1
2	WFM MEM 2
3	WFM MEM 3
4	WFM MEM 4

X5 Position 1
 $-256 \leq X5 \leq +255$

X6

X6	File Name 2
1	WFM MEM 1
2	WFM MEM 2
3	WFM MEM 3
4	WFM MEM 4

X7 Position 2
 $-256 \leq X7 \leq +255$

(37) AVERAGING

Format

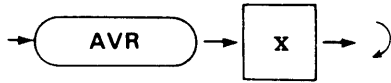

Parameter

X	Number of Average
0	OFF
1	2
2	4
3	8
4	16
5	32
6	64
7	128
8	256

(39) EQUIVALENT SAMPLING

Format

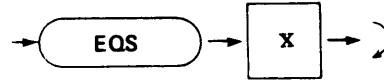

Parameter

X	On or Off
0	OFF
1	ON

(38) ENVELOPE (DS-6121A)

Format

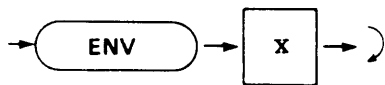

Parameter

X	with MAX HOLD or not
0	OFF
1	with MAX HOLD
2	without MAX HOLD

4-5 OPERATING PROCEDURES

Operating procedures are as follows.

Procedures

1. Set ADDRESS, DELIMITER, TALKER using the GP-IB ADDRESS switch on the DS-502.
2. Insert the DS-502 in the hole on the rear panel.
3. Connect the GP-IB multiconnector on DS-502 to the external controller (personal computer, etc.) by a cable.

Comment

The connector used is Model 57-20240-8D35 (manufactured by ANPHENOL/Dai-ichi Denshi Kogyo).

Cable for 24-pin type piggyback connector (e.g. 408JE-101, 102, and 104 by ANPHENOL/Dai-ichi Denshi Kogyo) can be used.

<Note>

Connection to a IEC-IB connector (25-pin) requires an additional converting connector.

4. The power switch of the instrument and the external controller is turned ON.

After completion of the operation above, the instrument can be controlled using a program on the external controller with GP-IB control command of the instrument.

Caution

When ADDRESS, DELIMITER, or TALKER of the instrument is to be changed, operate as in the following:

(1) When the power switch is ON

Change ADDRESS, DELIMITER or TALKER function by switches on the DS-502, and transmit DCL or SDC from the controller to place the instrument in the initial state.

(2) When the power switch is OFF

Reset ADDRESS, DELIMITER, or TALKER function by switches on the DS-502, and turn the power ON.

Connection or change in connection of GP-IB connector to an external instrument should be done after confirming that power switches of all instruments, GP-IB connector as well as external instruments, are in OFF state.

While operating with GP-IB, all power switches of instruments connected to the bus should be in ON state.

4-6 PROGRAM FLOW OF THE DS-6121/DS-6121A BY THE CONTROLLER

Described below is the standard procedures for controlling the DS-6121/DS-6121A via GP-IB interface.

Writing Waveform Data of DS-6121/DS-6121A

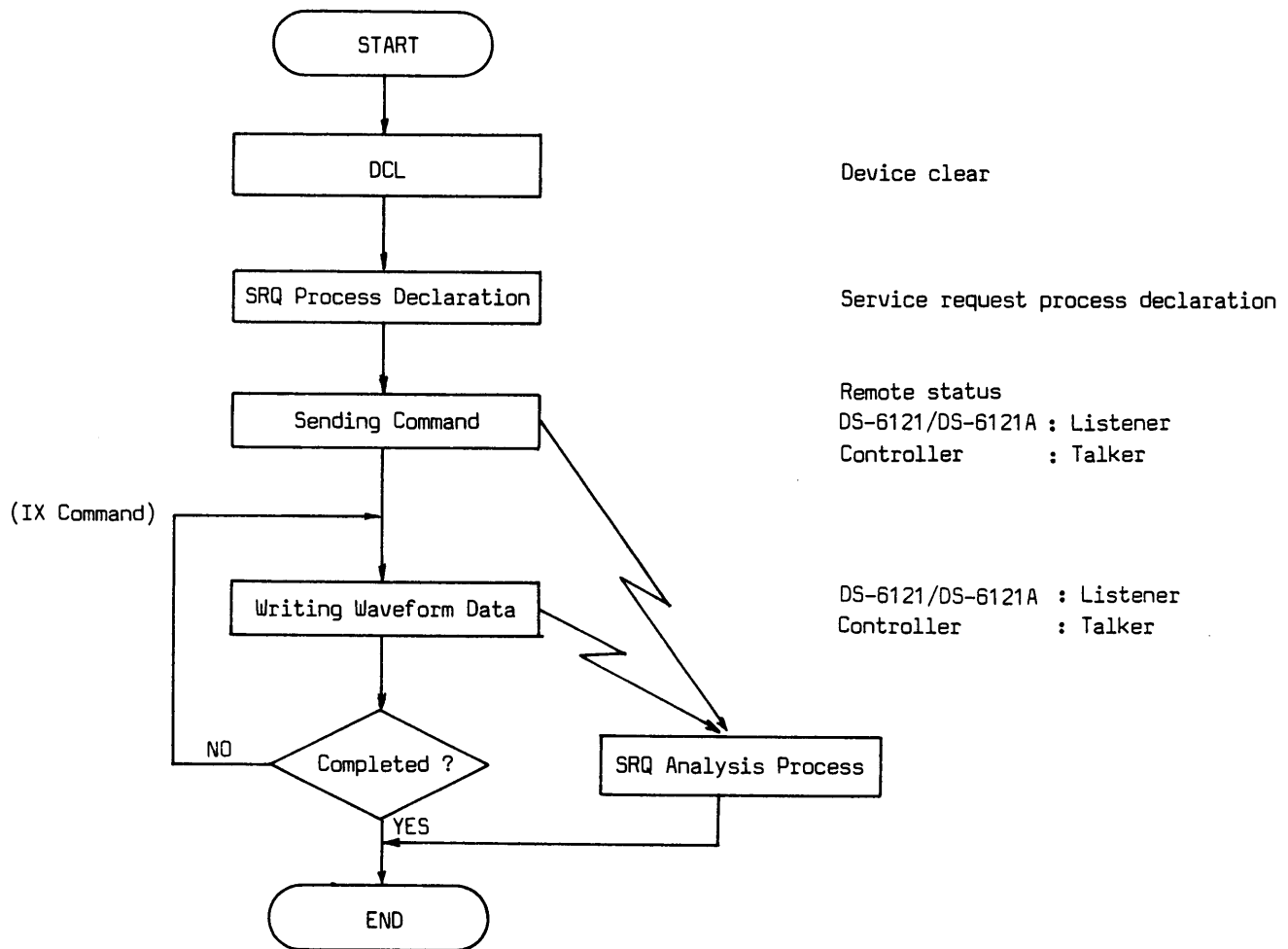

Read-out of Waveform Data from DS-6121/DS-6121A

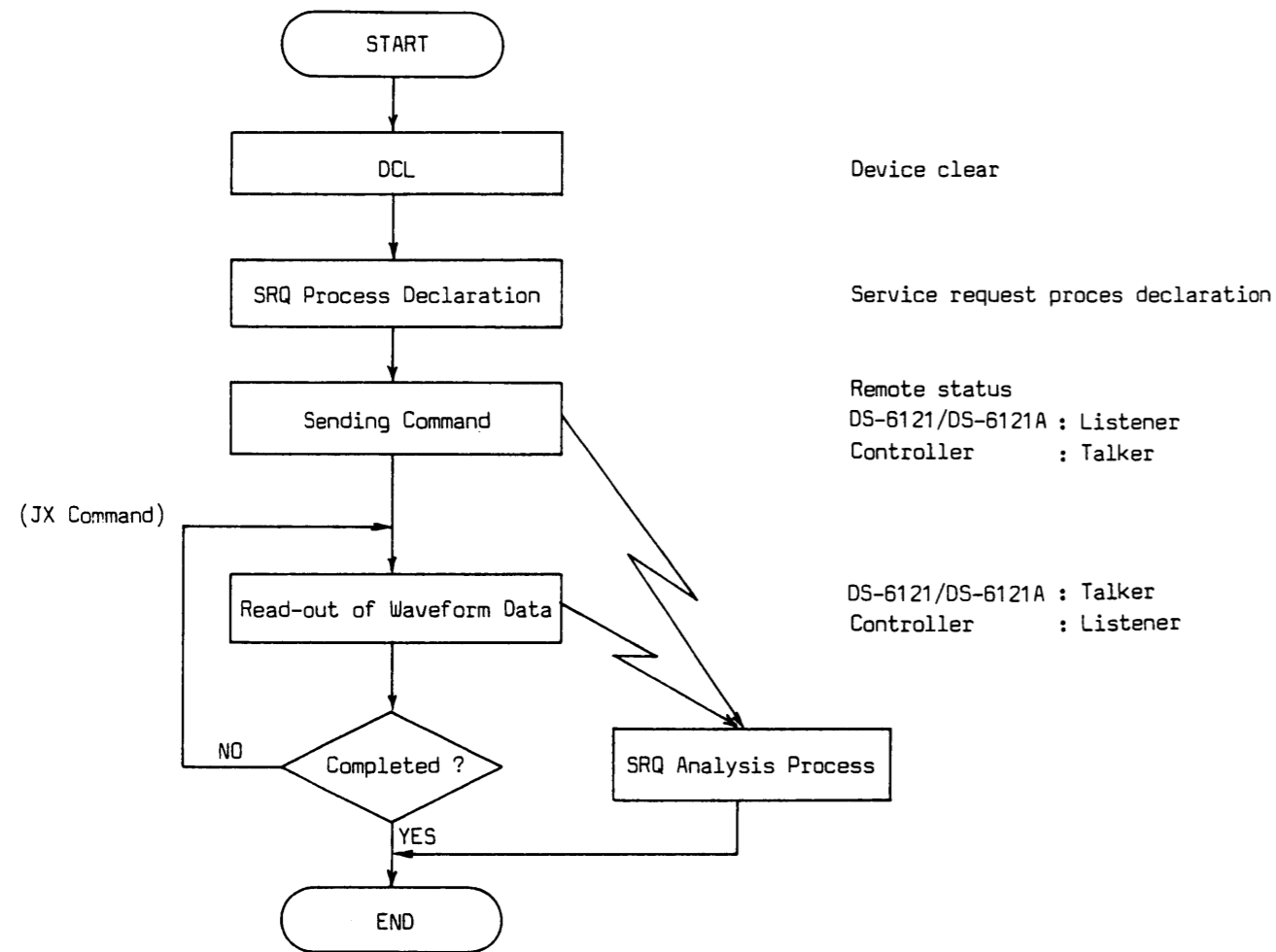

One Command Processing

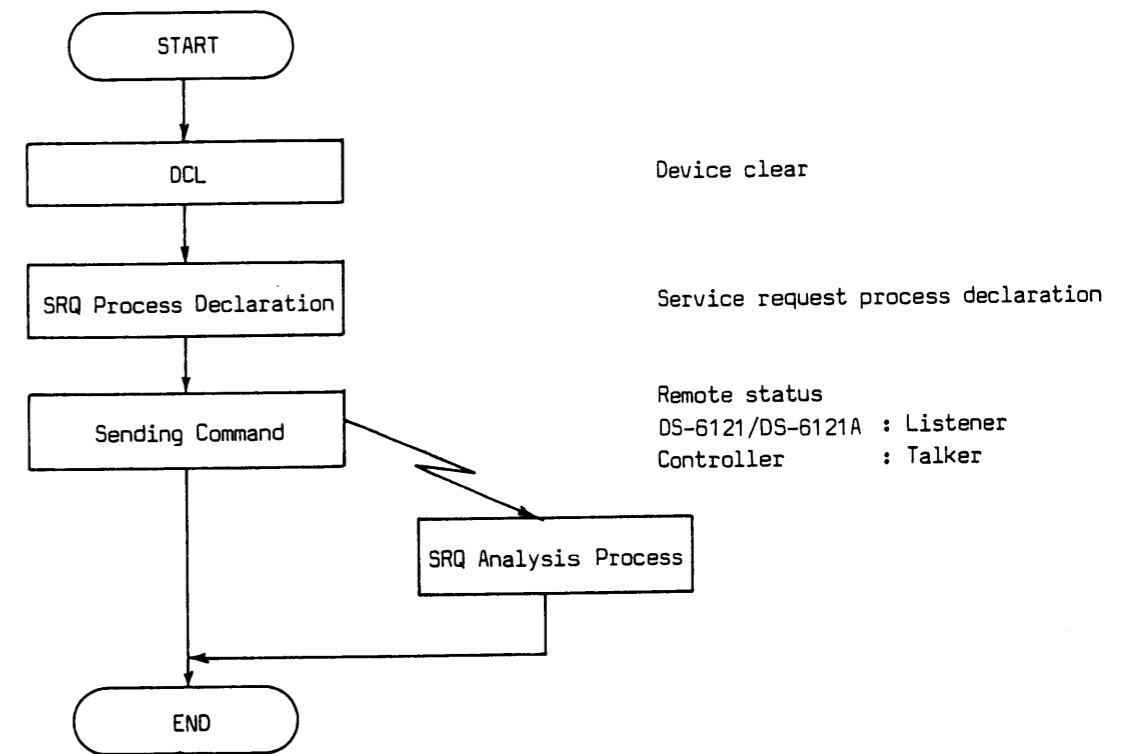

4-7 SAMPLE PROGRAM

Describes two sample programs that use the PC-9801 and HP-216 as external controller.

Overall Operations

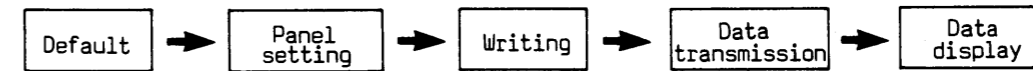

4-7-1 PC-9801

```

10 '
20 '
30 '
40 '
50 CONSOLE 0.25.0.1
60 CLS 3
70 '
100 DIM CH1DATA%(2047).CH2DATA%(2047).CH1AUX$(11).CH2AUX$(11)
110 '
120 CMD TIMEOUT=2
130 CMD DELIM=0
140 DS%=30
150 '
160 ISET IFC
170 ISET REN
180 WBYTE &H14;
190 '
200 ON SRQ GOSUB *SRQJUMP
210 SRQ ON
220 ON ERROR GOTO *TIMEOUT
230 '
240 PRINT@ DS%:"STU 1.7"
250 GOSUB *CH1SET
260 GOSUB *CH2SET
270 GOSUB *TRGSET
280 GOSUB *TIMESET
290 GOSUB *STRSET
300 GOSUB *WRTSUB
310 GOSUB *AUXRD
315   FOR I%=0 TO 1000 : NEXT I%
320 GOSUB *CH1READ
330 GOSUB *CH2READ
340 GOSUB *WAVEDISP
350 SRQ OFF
360 STOP
400 '
410 *CH1READ
420   PRINT@ DS%:"JX M10.1.2.0"
425   WBYTE 63, 64+DS%, 32+(IEEE(1)MOD 32);
430   FOR NUMB%=0 TO 2047
440     INPUT@ ;CH1DATA$ : CH1DATA%(NUMB%)=VAL(CH1DATA$)
450   NEXT NUMB%
460   RETURN
  
```

Comment

240 Recall DEFAULT setting by using SET RECALL/SAVE.

400 to 460 CH1 READ

2 kW data which is written from CH 1 of this unit is transmitted to an array declared by Ch 1 data of the controller.

```
500 .
510 *CH2READ
520     PRINT@ DS%:"JX M11.1.2.0"
525     WBYTE 63, 64+DS%, 32+(IEEE(1)MOD 32);
530     FOR NUMB%=0 TO 2047
540         INPUT@ :CH2DATA$ : CH2DATA%(NUMB%)=VAL(CH2DATA$)
550     NEXT NUMB%
560     RETURN
600 .
610 *CH1SET
620     PRINT@ DS%:"C1R 6"
630     PRINT@ DS%:"C1C 2"
640     PRINT@ DS%:"PS1 0"
650     RETURN
700 .
710 *CH2SET
720     PRINT@ DS%:"C2R 8"
730     PRINT@ DS%:"C2C 2"
740     PRINT@ DS%:"PS2 0"
750     PRINT@ DS%:"C2P 1"
760     RETURN
800 .
810 *TRGSET
820     PRINT@ DS%:"TAS 2"
830     PRINT@ DS%:"ATP 1"
840     PRINT@ DS%:"ATL 10"
850     RETURN
900 .
910 *TIMESET
920     PRINT@ DS%:"ATD 16"
930     RETURN
950 .
960 *STRSET
970     PRINT@ DS%:"OPM 3"
980     PRINT@ DS%:"MES 1"
990     PRINT@ DS%:"DTP 2"
1000    RETURN
1050 .
1060 *WRTSUB
1070     PRINT@ DS%:"RST"
1080     *LOOP1
1090     IF S<>64 THEN GOTO *LOOP1
1100     RETURN
1150 .
1160 *AUXRD
1170     PRINT@ DS%:"JX M10.7"
1180     FOR NUMB%=0 TO 11
1190         INPUT@ DS%:CH1AUX$(NUMB%)
1200     NEXT NUMB%
1205     FOR I%=0 TO 1000 : NEXT I%
1210     PRINT@ DS%:"JX M11.7"
1220     FOR NUMB%=0 TO 11
1230         INPUT@ DS%:CH2AUX$(NUMB%)
1240     NEXT NUMB%
1250     RETURN
```

Comment

500 to 560 CH2 READ
2 kW data which is written from CH 2 of this unit is transmitted to an array declared by Ch 2 data of the controller.

600 to 650 CH1 SET
Settings related to CH 1 amplifier.
Range 50 mV/div
Coupling DC
Position CENTER

700 to 760 CH2 SET
Settings related to CH 2 amplifier.
Range 0.2 V/div
Coupling DC
Position CENTER
Polarity INVERT

800 to 850 TRG SET
Settings related to trigger.
A trigger source CH 2
A trigger slope -
A trigger level 10%

900 to 930 TIME SET
Settings related to time axis.
A TIME/div 0.1 ms/div

950 to 1000 STR SET
Changes this unit to storage mode and sets the operation mode to single.

1050 to 1100 Wrtsub
Sets single reset to this unit. This instruction makes this unit a trigger wait state. When triggered, writing is started and SRQ is transmitted to the controller on completion of writing. When the controller receives an SRQ, serial polling is performed and when the number 64 is confirmed, the unit will get out of this routine.

1150 to 1250 Auxrd
Reads out auxiliary information.

```

1300
1310 *WAVEDISP
1320   SCREEN 3.0
1340   CLS 3
1350   GOSUB *MEASUR
1360   GOSUB *PRNAUX
1370   FOR X%=0 TO 2047 STEP 4
1380     CHIY%=(CH1DATA%(X%)/256-129)*(-1)
1390     PSET ((X%+1)/4+62,CHIY%).2
1400   NEXT X%
1410   FOR X%=0 TO 2047 STEP 4
1420     CH2Y%=(CH2DATA%(X%)/256-129)*(-1)
1430     PSET ((X%+1)/4+62,CH2Y%).1
1440   NEXT X%
1450   RETURN
1500 .
1510 *MEASUR
1520   LINE(63.0)-(575.257).7,B
1530   LINE(63.128)-(575.128).7
1540 .
1550   FOR I%=115 TO 523 STEP 51 : LINE(I%.0)-(I%.9).7 : NEXT I%
1560   FOR I%=115 TO 523 STEP 51 : LINE(I%.118)-(I%.138).7 : NEXT I%
1570   FOR I%=115 TO 523 STEP 51 : LINE(I%.257)-(I%.247).7 : NEXT I%
1580 .
1590   FOR I%=28 TO 231 STEP 25 : LINE(63,I%)-(73,I%).7 : NEXT I%
1600   FOR I%=28 TO 231 STEP 25 : LINE(575,I%)-(565,I%).7 : NEXT I%
1610   RETURN
1700 .
1710 *PRNAUX
1720   LOCATE 10,16 : PRINT "**** AUXILIARY INFORMATION ****"
1730   PRINT "CH1 : " ; : FOR NUMB%=0 TO 11 : PRINT CH1AUX$(NUMB%)+ " " ; : NEXT N
UMB%
1740   LOCATE 0,19
1750   PRINT "CH2 : " ; : FOR NUMB%=0 TO 11 : PRINT CH2AUX$(NUMB%)+ " " ; : NEXT N
UMB%
1760   COLOR@(0,17)-(79,18).2
1770   COLOR@(0,19)-(79,20).1
1780   RETURN
1800 .
1810 *TIMEOUT
1820   ERRNUMB=ERR
1830   IF ERRNUMB=128 THEN PRINT "TIMEOUT"
1840   IF ERRNUMB=131 THEN PRINT "NO ACTIV DEVICE"
1850   STOP
1900 .
1910 *SRQJUMP
1920   POLL DS%.S
1930   PRINT " ***** INTERRUPTED S = " ; S
1940   SRQ ON
1950   RETURN
1960 .
1970 END

```

Comment

1300 to 1450 Wavedisp

Waveforms are displayed based on the data stored in the arrays Ch 1 data and Ch 2 data.
However, the upper part of the waveform represents CH 1 and the lower, CH 2.

4-7-2 HP-216

```

10      !
20      !      DS-6121/DS-6121A SAMPLE PROGRAM
30      !
40      !
50      Ds=730                                ! DS-6121/DS-6121A GP-IB ADDRESS
60      INTEGER Ch1data(2047)
70      INTEGER Ch2data(2047)
80      !
90      ON TIMEOUT 7,2 GOSUB Timeout
100     ON INTR 7 GOSUB Srq
110     ENABLE INTR 7;2
120     ABORT 7
130     CLEAR 7
140     REMOTE 7
150     !
160     OUTPUT Ds USING "K";"STU 1,7"          ! SETUP DEFAULT
170     GOSUB Ch1set
180     GOSUB Ch2set
190     GOSUB Trgset
200     GOSUB Timeset
210     GOSUB Strset
220     GOSUB Wrtsub
230     GOSUB Auxrd
240     GOSUB Ch1read
250     WAIT 1
260     GOSUB Ch2read
270     GOSUB Wavedisp
280     STOP
290 Ch1read: !
300         OUTPUT Ds USING "K";"JX M10,3,2,0"
310         ENTER Ds USING "#,W";Ch1data(*)
320         RETURN
330 Ch2read: !
340         OUTPUT Ds USING "K";"JX M11,3,2,0"
350         ENTER Ds USING "#,W";Ch2data(*)
360         RETURN
370 Ch1set: !
380         OUTPUT Ds USING "K";"C1R 6"        ! CH1 RANGE 50mV/div
390         OUTPUT Ds USING "K";"C1C 2"        ! CH1 COUPLING DC
400         OUTPUT Ds USING "K";"PS1 0"       ! CH1 POSITION CENTER
410         RETURN
420 Ch2set: !
430         OUTPUT Ds USING "K";"C2R 8"        ! CH2 RANGE .2V/div
440         OUTPUT Ds USING "K";"C2C 2"        ! CH2 COUPLING DC
450         OUTPUT Ds USING "K";"FS2 0"       ! CH2 POSITION CENTER
460         OUTPUT Ds USING "K";"C2P 1"       ! POLARITY INVERT
470         RETURN

```

Comment

160 Recall DEFAULT setting by using SET RECALL/SAVE

290 to 320 Ch 1 read
2 kW data which is written from CH 1 of this unit is transmitted to an array declared by
Ch 1 data of the controller.

330 to 360 Ch 1 read
2 kW data which is written from CH 2 of this unit is transmitted to an array declared by
Ch 2 data of the controller.

370 to 410 Ch 1 set
Settings related to CH 1 amplifier.
Range 50 mV/div
Coupling DC
Position Midrange

420 to 470 Ch 2 set
Settings related to CH 2 amplifier.
Range 0.2 V/div
Coupling DC
Position Midrange
Polarity INVERT

```

480 Trgset: !
490     OUTPUT Ds USING "K"; "TAS 2"           ! TRIGGER A SOURCE CH2
500     OUTPUT Ds USING "K"; "ATP 1"         ! A TRIGGER SLOPE -
510     OUTPUT Ds USING "K"; "ATL 10"        ! A TRIGGER LEVEL 10
520     RETURN
530 Timeset: !
540     OUTPUT Ds USING "K"; "ATD 16"         ! A TIME .1ms/div
550     RETURN
560 Strset: !
570     OUTPUT Ds USING "K"; "OPM 3"         ! OP. (SWEEP) MODE SINGLE
580     OUTPUT Ds USING "K"; "MES 1"         ! STORAGE ON
590     OUTPUT Ds USING "K"; "DTP 2"         ! DATA POSITION CENTER
600     RETURN
610 Wrtsub: !
620     OUTPUT Ds USING "K"; "RST"           ! SINGLE RESET
630     IF S<>64 THEN GOTO 630               ! WRITE END WAIT
640     RETURN
650 Auxrd: !
660     OUTPUT Ds USING "K"; "JX M10,7"
670     FOR I=0 TO 11
680         ENTER Ds USING "K"; Ch1aux#
690         PRINT Ch1aux#
700     NEXT I
710     WAIT .5
720     OUTPUT Ds USING "K"; "JX M11,7"
730     FOR I=0 TO 11
740         ENTER Ds USING "K"; Ch2aux#
750         PRINT Ch2aux#
760     NEXT I
770     RETURN
780 Wavedisp: !
790     GRAPHICS ON
800     WINDOW 0,2047,-256,256
810     VIEWPORT 0,400,0,200
820     MOVE 0,0
830     FOR I=0 TO 2047
840         Ch1d=Ch1data(I)/256+128
850         PLOT I,Ch1d
860     NEXT I
870     MOVE 0,0
880     FOR I=0 TO 2047
890         Ch2d=Ch2data(I)/256*(-1)-128
900         PLOT I,Ch2d
910     NEXT I
920     RETURN
930 Srq: !
940     S=SPOLL(Ds)
950     PRINT "***** INTERRUPTED S=";S
960     ENABLE INTR 7
970     RETURN
980 Timeout: !
990     DISP "** ** ** TIMEOUT ERROR ** ** **"
1000    RETURN
1010    END

```

Comment

- 480 to 520 TRG SET
Settings related to trigger.
A trigger source CH 2
A trigger slope -
A trigger level 10%
- 530 to 550 Time set
Settings related to time axis.
A TIME/div 0.1 ms/div
- 560 to 600 Strset
Changes this unit to storage mode and sets the operation mode to single.
- 610 to 640 Wrtsub
Sets single reset to this unit. This instruction makes this unit a trigger wait state. When triggered, writing is started and SRQ is transmitted to the controller on completion of writing. When the controller receives an SRQ, serial polling is performed and when the number 64 is confirmed, the unit will get out of this routine.
- 650 to 770 Auxrd
Reads out auxiliary information.
- 778 to 920 Wavedisp
Waveforms are displayed based on the data stored in the arrays Ch 1 data and Ch 2 data. However, the upper part of the waveform represents CH 1 and the lower, CH 2.

MEMO

Section 5 RS-232-C Interface (Option)

5-1 GENERAL

By inserting the Interface Unit DS-503 into DS-6121/DS-6121A (hereafter called the instrument), control of such function as writing, reading, etc. is enabled by using an external controller.

Its specification is in compliance with EIA RS-232-C electronically and mechanically.

Installing

Insert the unit DS-503 in a compartment on the rear panel (refer to Figure 5-1).

Caution

Be sure to install the DS-503 at the power switch OFF status.

5-1-1 Specifications of RS-232-C

Asynchronous/Synchronous

Asynchronous data communication

Stop Bits

1 bit or 2 bits

Parity Enable

Disabled or Enabled

Parity Sense

Odd parity or even parity

Character Length

7 bits or 8 bits

Baud Rate

110 BPS, 300 BPS, 600 BPS, 1200 BPS, 2400 BPS, 4800 BPS, 9600 BPS or 19200 BPS

Figure 5-1. Installation of the DS-503

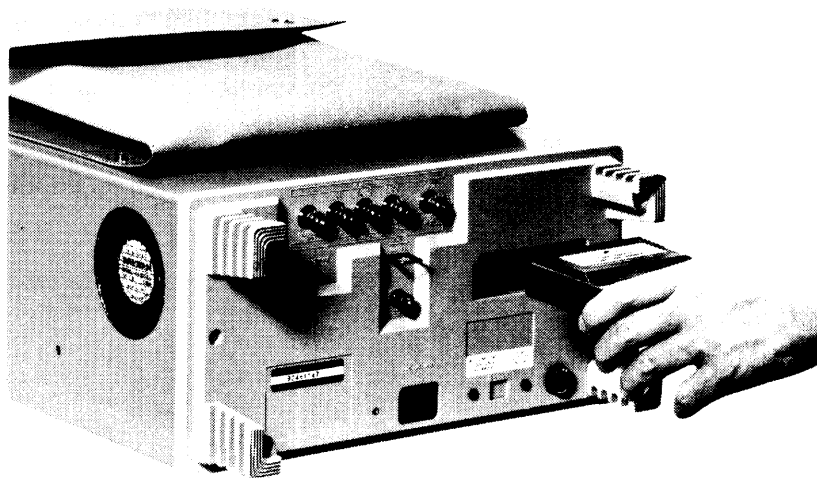

5-1-2 Construction

The instrument can be connected to the following equipment via RS-232-C.

1. Digital Stagescope DS-6121/DS-6121A
2. Printer
3. Plotter *1 IWATSU format
(SR-6620, SR-6602, SR-6625)
HP-GL format
(SR-6620H, HP-7440A, HP-7470A,
HP-745A)
4. Other controllable equipment by RS-232-C

*1 The plotters are connectable without external controller.

5-1-3 Signal Line and the Number of Connection Pin

Input and Output Circuits

Input and output circuits of the RS-232-C are as follows.

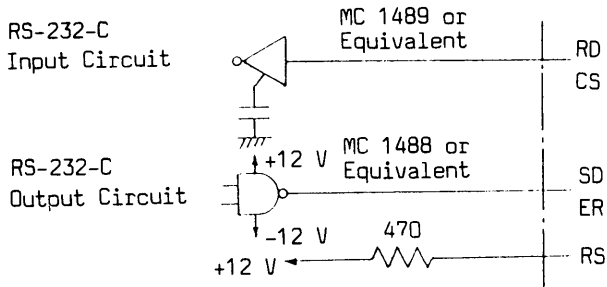

Shown in Table 5-1-3 is the signal line of input/output signals and the number of connector pin, and in Figure 5-1-3 the number and position of the connector pin.

Table 5-1-3. Single Line and Pin assignments

RS-232-C Pin No.	Signal Line (Mnemonic)	I/O	Function
1	FG		Frame Ground
2	SD	Out	Sent Data
3	RD	In	Received Data
4	RS	Out	Request to Send
5	CS	In	Clear to Send
6	NC		No connection
7	SG		Signal Ground
8	}		No connection
19			
20	ER	Out	Data Terminal Ready
21	}		No connection
25			

Signal Line

SD (Sent Data)

- Mark 1 in "L" output
- Space 0 in "H" output

RD (Received Data)

Logic is the same as the Sent Data.

RS (Request to Send)

Requests sending for the external equipments in active "H". In this unit, "H" is always output.

CS (Clear to Send)

Enables this unit to send in active "H" input.

ER (Data Terminal Ready)

Indicates that this unit can send or receive data in active "H" output.

FG (Frame Ground)

Grounding for maintenance to the unit's frame.

SG (Signal Ground)

Common grounding for all the signals

Figure 5-1-3. RS-232-C Connector and Pin assignment

RS-232-C

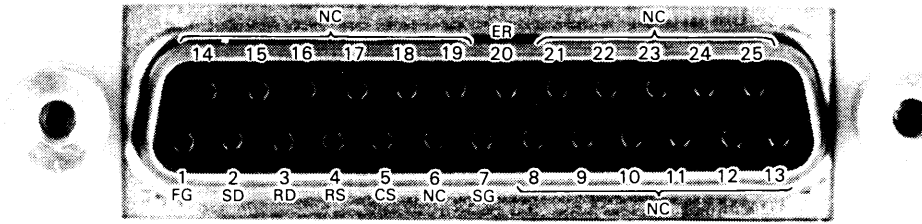

5-1-4 Connection to External Equipments

Connecting Cable

Use the attached cable SX-0072 when connecting to external equipments.

The connector side is 17JE-23250-02 (D8A). The end of the cable should be adapted to the interface specifications of the external equipment after processing as shown in Figure 5-1-4-1.

Method of Processing Cable

- ① Cut the cable to the required length and remove the outer shield about 5 mm.
- ② Cut the shield-weave line with remaining length of 1 cm, bend onto the shield and cover the attached tube for external equipments after soldering the lead wire for FG (Frame Ground).
- ③ Connect each signal line to the connecting terminal. Process the unnecessary end of the lines by covering them with heat-contractive cable.

Connection to Plotter

When connecting to IWATSU's plotter (SR-6620, SR-6602, SR-6625) and HP-GL format plotter (SR-6620H, HP-7440A, HP-7470A, HP-7475A), make the switch setting same as each interface for both DS-6121 and the plotter in terms of baud rate, character length, parity enable, parity sense, stop bit length and delimiter. Use the connecting cable SX-0073 (sold separately).

The output procedure for the plotter is the same as the case of use of GP-IB.

Figure 5-1-4-1. Connecting Cable SX-0072

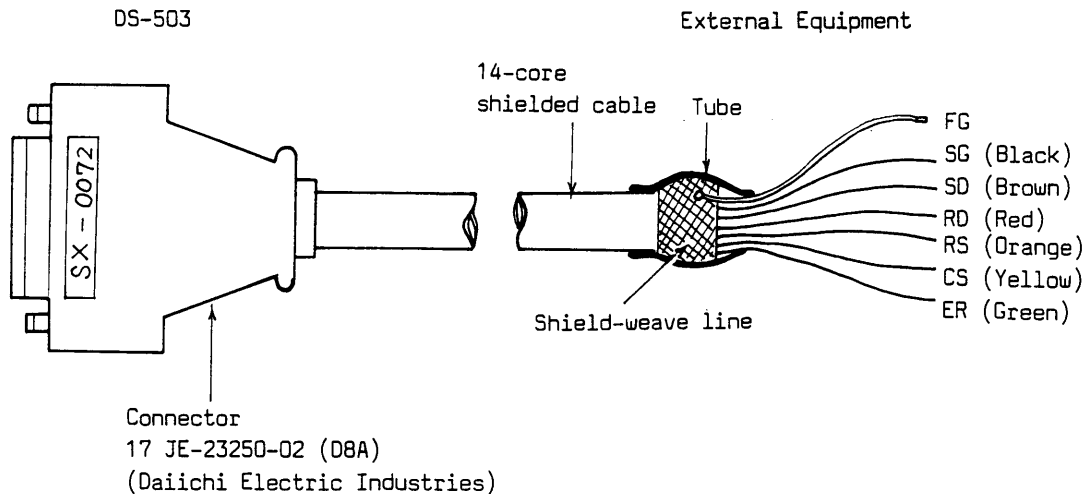

Figure 5-1-4-2. Connecting Cable SX-0072

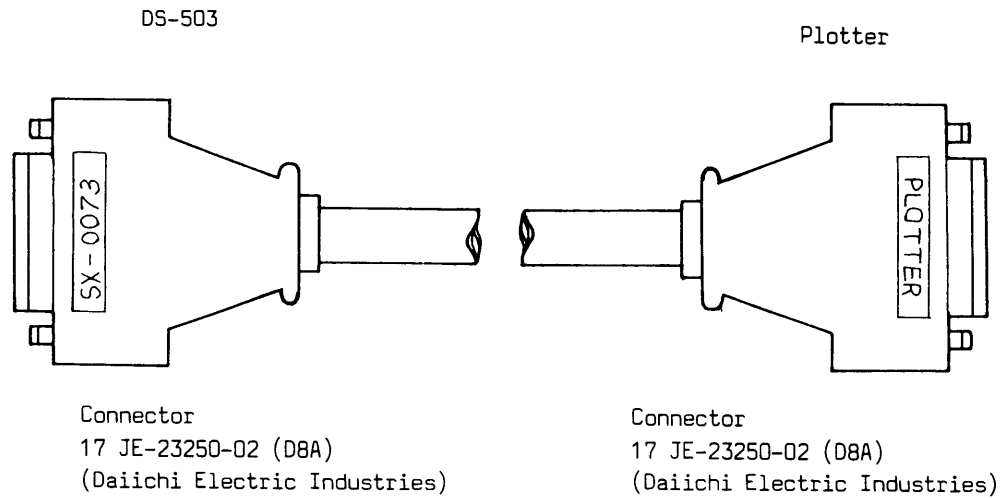
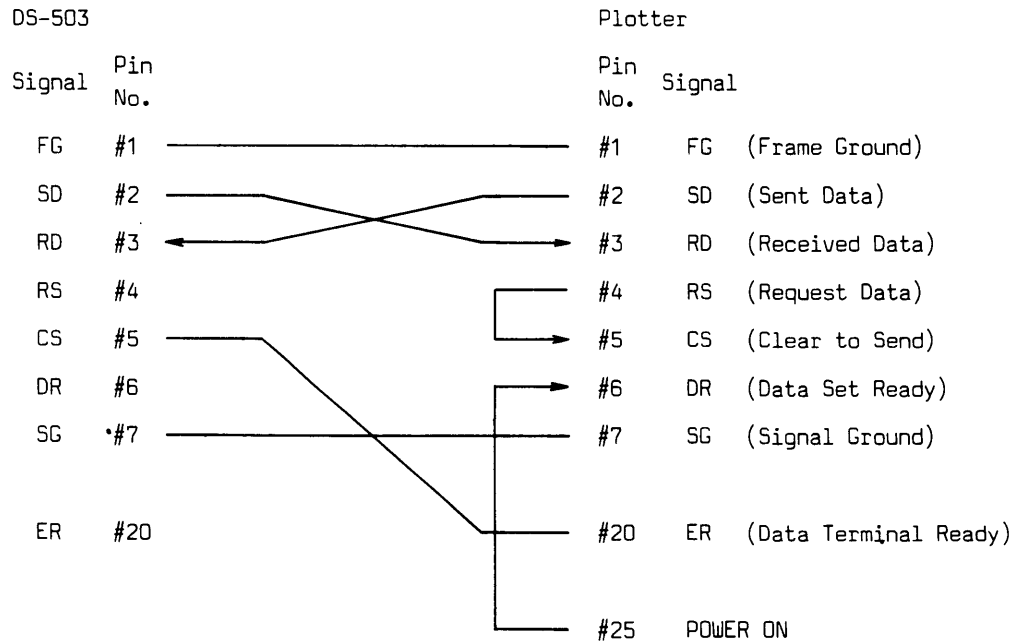

Figure 5-1-4-3. Connecting Signal Lines



5-1-5 Character Format, Handshake and Echo-back Process Character Format

Character Format

An example of character frame on the data line is in the following figure.

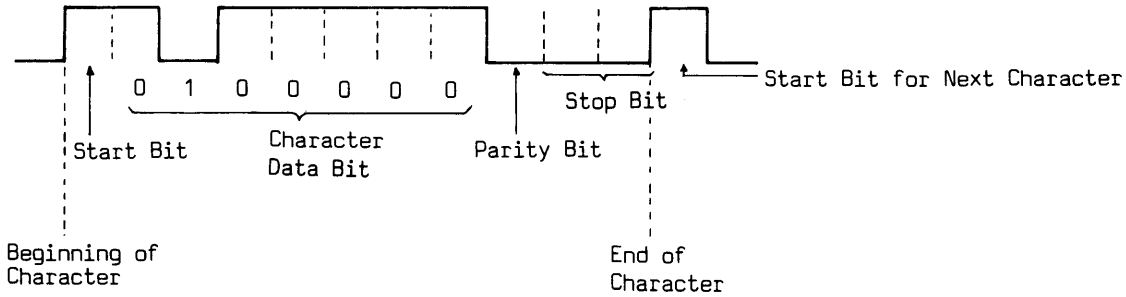

The following is the contents of a character frame.

Start Bit

A start bit announces a receiving equipment that a new character is being sent out.

Character Data Bit

A character data bit is a binary code for which the character to be transmitted. Set to 7 bits or 8 bits.

Parity Bit

A parity bit is to detect whether each bit in a character is correctly received and error is detected by making total number of bit "1" in the entire characters sent either even or odd. Set to parity enable and parity sense.

Stop Bit

A stop bit indicates the end of each character. Set to 1 bit or 2 bits.

Handshake

- 1) When sending data from the instrument
 1. Make ER line and RS line active "H". However, in the instrument, RS line is always "H".
 2. Check that CS line is active "H".
 3. Send the data.
 4. Make ER line "L" after sending the data.
- 2) When the instrument receiving data
 1. Make ER line active "H".
 2. Receive the data.
 3. Make ER line "L" after receiving the data.

The above operations are automatically executed by RS-232-C unit.

Error Display

When the instrument receives data, error display will be given if data is incorrect.

- Parity Error

When a parity bit is set, this will be displayed if the calculated value of parity bit for received data and the actual value received do not match.

- Framing Error

This will be displayed if the data which does not match the set character frame is received.

Echo-back Process

When sending data from external equipment to the instrument. The instrument sends the same data as the received one to the external equipment as echo-back. Send the next data to the instrument. When no error occurs if the original data sent by the external equipment and the data echoed back are compared.

If echo-back is not received and the next data is sent, that is regarded as malfunction. Perform echo-back process character by character.

However, the data sent from the instrument do not demand echo-back process for the external equipment.

5-2 SETTING OF SWITCHES

Set baud rate, character length, parity enable, parity sense and stop bit length by switch 1 and delimiter by switch 2 of RS-232-C unit DS-503.

5-2-1 Setting of Switch 1

Baud Rate

Set baud rate by switches of 3 bit B3 to B1.

Baud Rate (BPS)	B3	B2	B1
110	0	0	0
300	0	0	1
600	0	1	0
1200	0	1	1
2400	1	0	0
4800	1	0	1
9600	1	1	0
19200	1	1	1

Character Length

Set character length by switch C.

Character Length (Bit)	C
7	0
8	1

Parity Enable

Set parity enable by switch P.

Parity	P
Disable	0
Enable	1

Parity Sense

Set parity sense by switch OE.

Parity	OE
Odd	0
Even	1

Stop Bit

Set stop bit sense by switch S.

Stop Bit	S
1	0
2	1

5-2-2 Setting of Switch 2 (Delimiter)

Set the type of delimiter in data I/O by D1 and D2.

D2	D1	Delimiter
0	0	LF
0	1	LF
1	0	CR
1	1	CR LF

LF : Line Feed

CR : Carriage Return

Figure 5-2. Sample switch setting

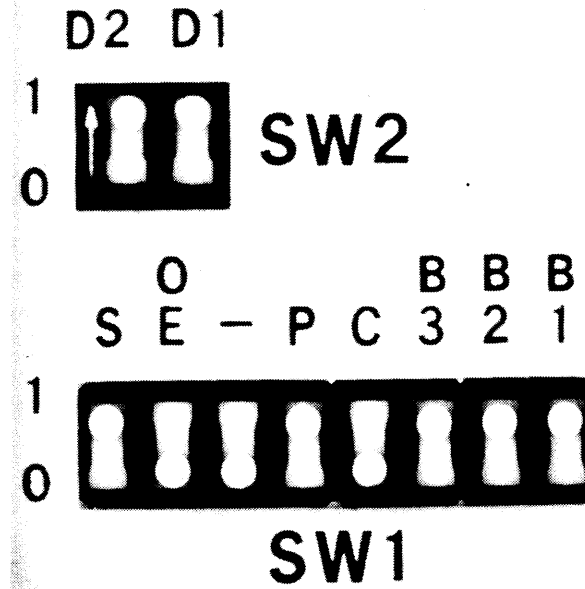

Baud Rate (B3 to B1)
Set to 19,200 BPS.

Character Length (C)
Set to 7 bits.

Parity Enable (P)
Set to Enable.

Parity Sense (OE)
Set to Odd.

Stop Bit (S)
Set to 2.

Delimiter
Set to CR LF.

5-3 FUNCTION

5-3-1 Outline

Remote operation functions are classified into the following:

a. Data transmission

(a) Data Read-out

Information on panel setting can be outputted collectively. The waveform data can be outputted.

(b) Data Writing

Panel setting information can be inputted collectively. The waveform data can be inputted in special regions.

b. Panel operations

The panel operations can be done separately or collectively. Information on panel setting is outputted separately or collectively.

c. Status Output

- (a) Unlocking of panel keys
- (b) Locking of panel keys

5-3-2 Data Transmission

a. This function are classified into the following four kinds:

1. Collective read-out of SET-UP data (panel setting information)
2. Read-out of displayed waveform data
3. Collective writing of SET-UP data
4. Writing of displayed waveform data

b. The transferred contents to be the object of transfer are:

SET-UP data: Same as individual operations in "4-3-3 Panel Operations".

Displayed waveform data: Waveform data (main information), waveform auxiliary information

c. Collective read-out and writing of SET-UP data

By reading out and storing several kinds of contents of manual setting by using collective read-out, necessary settings are easily realized without considering combination of individual operations.

However, contents of collective read-out are internal codes (table) and basically not open to the users.

d. Number of data for waveform data

• Norm mode

CAPTURE memory captures 2048 data in any sweep range and transfers these to external device.

In the range slower than 10 μ S/div (5 μ S/div in 1 channel operation), screen and data length may match but in the range faster than 5 μ S/div (2 μ S/div in 1 channel operation), they may not match. For example, in 5 μ S/div, the first 1024 data may correspond with the screen.

In other words, in the range faster than 10 μ S/div (40 MHz clock in the one faster than 5 μ S/div for the 1 channel operation), sampling is always made in 20 MHz clock, 2048 data are captured and they are transmitted to external devices.

<Note> All the storage modes except for equivalent sampling (EQU-SAMPLING) mode and envelope mode.

• Envelope mode (DS-6121A)

CAPTURE memory captures 2048 data in any sweep range and transfers these to external device.

In the range slower than 50 μ S/div, screen and data length may match but in the range faster than 20 μ S/div, they may not match. For example, in 20 μ S/div, the first 819 data may correspond with the screen.

In other words, in the range faster than 50 μ S/div of MAX and MIN data is alternately made in 4 MHz clock, 2048 data are captured and they are transmitted to external devices.

e. Waveform auxiliary information

The waveform auxiliary information is used in the following cases.

1. When DS-6121/DS-6121A is connected to other equipments made by Iwatsu (SM-2700, etc.):

These external equipments will use the waveform auxiliary information for processing.

2. When the user wants to know the sampling block and vertical axis sensitivity of the waveform data:

The sampling block or vertical axis sensitivity cannot be read out from SET-UP data. As mentioned before, this is because SET-UP data are external codes and not open to users.

The contents transmitted and their order are as shown in the following table.

Order	Contents	Format
1	Number of waveform auxiliary information	AA) 6)
2	Type of binary data	AB) 2)
3	Data of length	AC) 2)
4	Δx	AD) 2.5E-6)
5	Y-FULL SCALE	AE) 0.102E+0)
6	DELAY value	AF) 0)

Two alphabet letters: Identification code
) : Delimiter

Comment

- Number of waveform auxiliary information
For DS-6121/DS-6121A, they are six and the number is fixed.
- Type of binary data
Binary data of waveform data (main information).
0 : Binary transmit mode ineffective (ASCII)
2 : 2 bytes/1 data
- Data length
The length of waveform data.rm data.
1 : 1024
2 : 2048
- Δx
This is a sampling clock cycle when the waveform is captured.
The display is with exponential format and the unit is [sec].
Example: 2.5E-6 → Sampling cycle of 2.5 μ S
(Equivalent to 0.5 mS/div)
- Y-FULL SCALE
This is the full-scale value of vertical (Y) axis.
The unit for this value is volt (V).
Example: 0.102E+0 → 0.1024V full-scale (equivalent to 10 mV/div)

6. DELAY value
Fixs to 0.

Example of reading out of waveform auxiliary

Example: Reading out of waveform auxiliary information for CH 1

JX M10, 7

You cannot write waveform auxiliary information.

In other words, IX M10, 7 is impossible.

f. Input and output format of waveform data

Same as the GP-IB format (see to page 4-7)

5-3-3 Panel Operations

Individual panel operations can be performed. The operation procedure is the same as the manual operation procedure. The lamps (LEDs) on the panel in the individual operation mode operate in the same way as manual operation.

a. The following individual operations can be performed:

Measuring condition setting
Display
Output
Processing

b. Restrictions

The following are excepted from individual operations:
Power ON/OFF
A INTENSITY
CHARACTER INTENSITY
ENHANCE
BEAM FIND
FOCUS
ASTIG
SCALE
TRACE ROTATION

Caution

Collective setting (writting) or read-out of panel operations can be performed by following the item 4-3-2.

5-4 DETAILS OF RS-232-C COMMANDS

5-4-1 Waveform Data Read Command

Function: To read data from files to the RS-232-C.

The data read out by this command are:

- Setup data
- Waveform data
- Auxiliary information of waveform data

Format

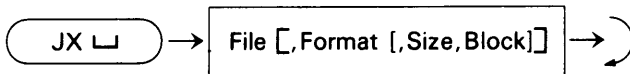

Parameters

a. File

- Input buffer memory file M10, M11
- Current setup file S

b. Format

- Data record format for data transfer
- Set value

Format	Code	Data Expression	No. of Bytes for a String	Record Discriminator
1	ASCII	Integer	8 bytes max.	LF, CR or CR LF
3	Binary	1 word	2 bytes	2 bytes
7	ASCII	Combination	Variable	LF, CR or CR LF

<Note> Combination in the data expression column means a combination of an integer, real number, floating decimal point, and alphanumerics.

c. Size

Parameter that specifies the size of main information to be read out from a file in units 1k words

- Set values: 1 or 2
- 1: 1k words
 - 2: 2k words

d. Block

Transfer start block number

Parameter that specifies a file block number to start reading main information

- Set value 0 or 1

<Note> If block 1 is specified, the preceding parameter's <size> will always be 1.

Block size: 1 word

Block numbers 0 and 1 to be assigned every kilo-bytes, starting with the smallest address number.

Memory 2k data

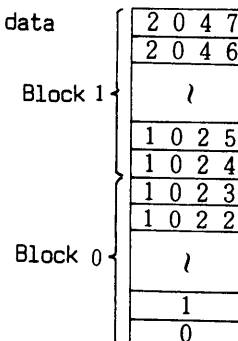

Caution

The following three combinations of size and block are allowed.

<i>Size</i>	<i>Block</i>
<i>1</i>	<i>0</i>
<i>1</i>	<i>1</i>
<i>2</i>	<i>0</i>

JX commands

The following seven types are allowed concerning "JX" command.

- (1) Auxiliary information on the data stored in buffer memory 1 is sent. Format 7 is specified.

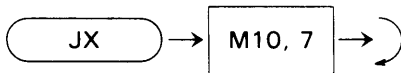

- (2) Auxiliary information on the data stored in buffer memory 2 is sent. Format 7 is specified.

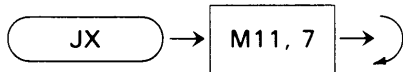

- (3) The data stored in buffer memory 1 is transferred in ASCII code.

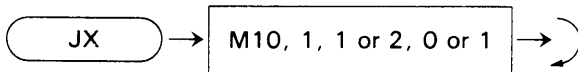

- (4) The data stored in buffer memory 2 is transferred in ASCII code.

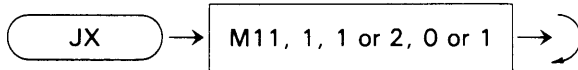

5-4-2 Waveform Data Write Command

Function: To write data from the GP-IB to files.
 The data written by this command are:
 Setup data
 Waveform data

Format

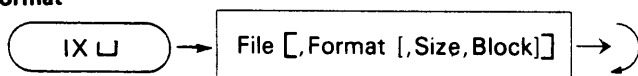

Parameters

- a. File
- Input buffer memory file M10 (CH 1), M11 (CH 2)
 - Current setup file S

- b. Format
- Data record format for data transfer
 - Set value

Format	Code	Data Expression	No. of Bytes for a String	Record Discriminator
1	ASCII	Integer	8 bytes max.	LF, CR or CR LF
3	Binary	1 word	2 bytes	2 bytes
7	ASCII	Combination	Variable	LF, CR or CR LF

<Note> Combination in the data expression column means a combination of an integer, real number, floating decimal point, and alphanumerics.

- c. Size
 Parameter that specifies the size of main information to be read out from a file in units 1k words
 Set values: 1 or 2 1: 1k words
 2: 2k words
- d. Block
 Transfer start block number
 Parameter that specifies a file block number to start reading main information
 • Set value 0 or 1
 <Note> If block 1 is specified, the preceding parameter's <size> will always be 1.

Caution

No IX for auxiliary information.

IX commands

The following five types are allowed concerning "IX" command.

(1) The data stored in buffer memory 1 is transferred in ASCII code.

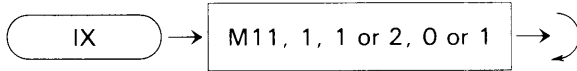

(2) The data stored in buffer memory 2 is transferred in ASCII code.

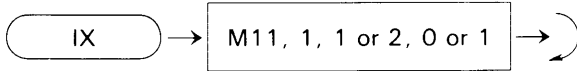

Corresponding List (panel key to RS-232-C command)

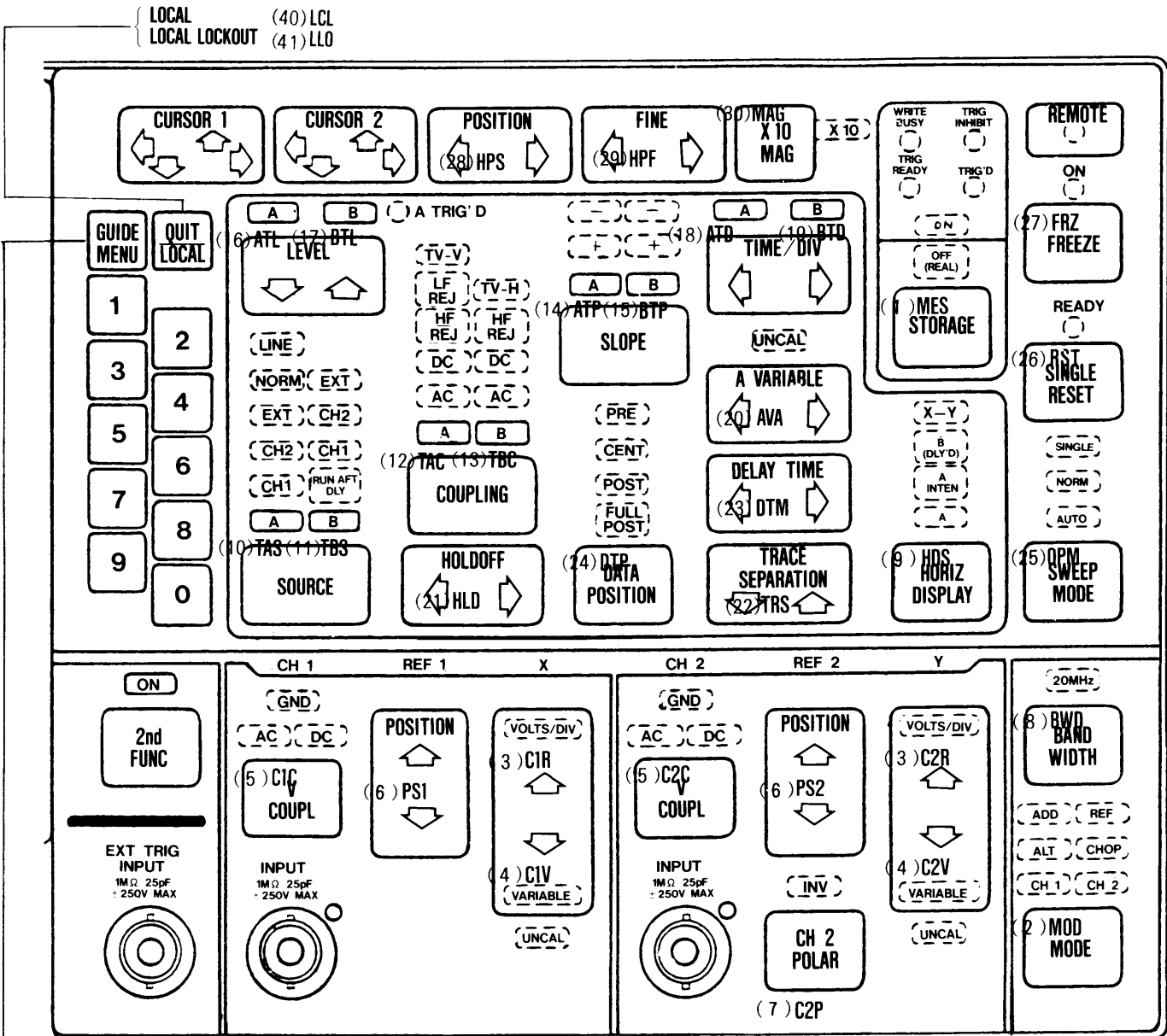

<Note> RS-232-C commands are shown in red.

- Cursor Measurement (31) CUR
- SETUP RECALL/SAVE (32) STU
- WAVEFORM RECALL (33) WFM 1
- SAVE WFM 2
- MOVE WFM 3
- CURVE INTERPOLATION (34) IPL
- CALCULATION (35) CAL
- GO/NO JUDGEMENT
- a. Cursor-Cursor (36) YNC
- b. Waveform-Cursor YNW
- AVERAGING (37) AVR
- ENVELOPE (DS-6121A) (38) ENV
- EQU-SAMPLING (39) EQS

Commands List

Commands	Contents	Parameter (1)
(1) MES	Measuring mode	0: STORAGE OFF 1: STORAGE ON
(2) MOD	Vertical mode	1: CH 1 2: CH 2 3: ALT 4: CHOP 5: ADD 6: CH 1 & CH 2 7: CH 1 CH 2 & REF
(3) C1R C2R	CH 1 VOLTS/DIV CH 2 VOLTS/DIV	1: 1 mV 2: 2 mV 3: 5 mV 4: 10 mV 5: 20 mV 6: 50 mV 7: 0.1 V 8: 0.2 V 9: 0.5 V 10: 1 V 11: 2 V 12: 5 V
(4) C1V C2V	CH 1 VARIABLE CH 2 VARIABLE	0 ≤ ~ ≤ 255
(5) C1C C2C	CH 1 COUPLING CH 2 COUPLING	0: AC 1: GND 2: DC
(6) PS 1 PS 2	CH 1 Vert. POSITION CH 2 Vert. POSITION	-1024 ≤ ~ ≤ +1023
(7) C2P	CH 2 POLARITY	0: NORMAL 1: INVERT
(8) BWD	BANDWIDTH	0: OFF 1: ON (20MHz)
(9) HDS	HORIZ DISPLAY	1: A 2: A INTEN 3: A INTEN & B (BLY'D) 4: B (BLY'D) 5: X-Y
(10) TAS	A TRIGGER SOURCE	1: CH 1 2: CH 2 3: EXT 4: NORM 5: LINE
(11) TBS	B TRIGGER SOURCE	0: RUN AFTER DELAY 1: CH 1 2: CH 2 3: EXT
(12) TAC	A TRIGGER COUPLING	1: AC 2: DC 3: HF REJ 4: LF REJ 5: TV-V
(13) TBC	B TRIGGER COUPLING	1: AC 2: DC 3: HF REJ
(14) ATP	A TRIGGER SLOPE	0: + 1: -
(15) BTP	B TRIGGER SLOPE	0: + 1: -
(16) ATL	A TRIGGER LEVEL	-100 ≤ ~ ≤ +100
(17) BTL	B TRIGGER LEVEL	-100 ≤ ~ ≤ +100
(18) ATD	A TIME/DIV	0: EXT CLOCK 1: 10 s 2: 5 s 3: 2 s 4: 1 s 5: 0.5 s 6: 0.2 s 7: 0.1 s 8: 50 ms 9: 20 ms 10: 10 ms 11: 5 ms 12: 2 ms 13: 1 ms 14: 0.5 ms 15: 0.2 ms 16: 0.1 ms 17: 50 μs 18: 20 μs 19: 10 μs 20: 5 μs 21: 2 μs 22: 1 μs 23: 0.5 μs 24: 0.2 μs 25: 0.1 μs 26: 50 ns 27: 20 ns
(19) BTD	B TIME/DIV	7: 0.1 s 8: 50 ms 9: 20 ms 10: 10 ms 11: 5 ms 12: 2 ms 13: 1 ms 14: 0.5 ms 15: 0.2 ms 16: 0.1 ms 17: 50 μs 18: 20 μs 19: 10 μs 20: 5 μs 21: 2 μs 22: 1 μs 23: 0.5 μs 24: 0.2 μs 25: 0.1 μs 26: 50 ns 27: 20 ns
(20) AVA	A VARIABLE	0 ≤ ~ ≤ 255
(21) HLD	HOLD OFF	0 ≤ ~ ≤ 200
(22) TRS	TRACE SEPARATION	0 ≤ ~ ≤ 255
(23) DTM	DELAY TIME	0.20 ≤ ~ ≤ 10.20

Commands	Contents	Parameter (1)	Parameter (2)	Parameter (3)
(24) DTP	DATA POSITION	0: FULL POST 1: POST 2: CENTER 3: PRE		
(25) OPM	OPERATION mode	1: AUTO 2: NORM 3: SINGLE		
(26) RST	SINGLE RESET	No parameter		
(27) FRZ	FREEZE	0: OFF 1: ON		
(28) HPS	HORIZONTAL POSITION	-128 ≤ ~ ≤ +127		
(29) HPF	FINE (HOR. POSITION)	-8 ≤ ~ ≤ +7		
(30) MAG	MAG X10	0: OFF 1: ON		
(31) CUR	CURSOR measurement	0: OFF 1: ΔVOLTS 2: ΔTIME 3: ΔVOLTS ON WAVEFORM	ΔVOLTS -512 ≤ ~ ≤ +511 ΔTIME or ΔVOLTS ON WAVEFORM 0 ≤ ~ ≤ 2048	ΔVOLTS -512 ≤ ~ ≤ +511 ΔTIME or ΔVOLTS ON WAVEFORM 0 ≤ ~ ≤ 2048
(32) STU	SETUP RECALL/SAVE	1: RECALL 2: SAVE	1: SETUP MEM 1 2: SETUP MEM 2 3: SETUP MEM 3 4: SETUP MEM 4 5: SETUP (LAST DATA) 6: SETUP (POWER OFF) 7: DEFAULT	
(33) a. WFM 1	WAVEFORM RECALL	1: WFM MEM 1 2: WFM MEM 2 3: WFM MEM 3 4: WFM MEM 4	1: REF 1 2: REF 2	
b. WFM 2	WAVEFORM SAVE	1: CH 1 2: CH 2 3: REF 1 4: REF 2	1: WFM MEM 1 2: WFM MEM 2 3: WFM MEM 3 4: WFM MEM 4	
c. WFM 3	WAVEFORM MOVE	1: CH 1 → REF 1 2: CH 2 → REF 2 3: CH 1 → REF 1 CH 2 → REF 2 4: CH 1 → REF 2 5: CH 2 → REF 1 6: CH 1 → REF 2 CH 2 → REF 1		
(34) IPL	CURVE INTERPOLATION	0: OFF 1: ON		
(35) CAL	CALCULATION +, -, X	0: OFF 1: ON	1: + 2: - 3: X	
Commands	Contents	Parameter (1)	Parameter (2, 3)	Parameter (4, 5)
(36) a. YNC	GO/NO Cur. to Cur.	0: OFF 1: IN-RANGE 2: OUT-RANGE	-512 ≤ ~ ≤ +511	0 ≤ ~ ≤ +2047
Commands	Contents	Parameter (1)	Parameter (2, 3)	Parameter (4)
b. YNW	GO/NO Cur. to Wave	0: OFF 1: IN-RANGE 2: OUT-RANGE	0 ≤ ~ ≤ 2047	1: WFM MEM 1 2: WFM MEM 2 3: WFM MEM 3 4: WFM MEM 4
Commands	Contents	Parameter (1)	Parameter (2, 3)	Parameter (4)
		Parameter (5) -256 ≤ ~ ≤ +255	Parameter (6) 1: WFM MEM 1 2: WFM MEM 2 3: WFM MEM 3 4: WFM MEM 4	Parameter (7) -256 ≤ ~ ≤ +255
Commands	Contents	Parameter (1)	Parameter (2, 3)	Parameter (4)
(37) AVR	AVERAGING	0: OFF 1: 2 2: 4 3: 8 4: 16 5: 32 6: 64 7: 128 8: 256		
(38) ENV (DS-6121A)	ENVELOPE	0: OFF 1: with MAX HOLD 2: without MAX HOLD		
(39) EQS	EQUIVALENT SAMPLING	0: OFF 1: ON		
(40) LCL (RS-232-C)	LOCAL	No Parameter		
(41) LLO (RS-232-C)	LOCAL LOCK-OUT	0: OFF 1: ON		
(42) STB (RS-232-C)	STATUS	No Parameter		

5-4-3 Individual Panel Operations

5-4-3-1 Operations other than Remote/Local and Status Out

Refer to 4-4-3 Individual Panel Operations (on Pages 4-17 to 4-25).

5-4-3-2 Remote/Local

(39) Local

Function

When this command is received, operations through panel keys are enabled even in the local lockout condition.

Format

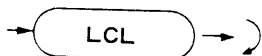

(40) Local Lockout

Function

When this command is received on Remote, changing of Remote/Local by  key is disabled.

Format

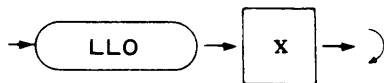

Parameter

X	On or Off
0	OFF
1	ON

(41) Status

Function

When this command is received, hereinafter, the following information is output once on completion of writing waveform or of averaging process.

Format

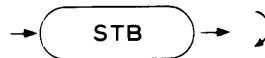

No Parameter

5-5 OPERATION

Connection of the DS-6121/DS-6121A with RS-232-C and the external controller and their operation are as follows.

1. Set baud rate, character length, parity enable, parity sense and stop bit by Switch 1 and delimiter by Switch 2.
2. Insert RS-232-C unit • DS-503 in the hole on the rear panel.
3. Connect RS-232-C multiconnector on DS-503 to an external controller (personal computer, etc.) by a cable.
4. Turn the power switch of the external controller ON.
5. Turn the power switch of DS-6121/DS-6121A ON.

<Note> When connected to a plotter, FRAMING ERROR or OVERRUN ERROR will be displayed on CRT if the plotter is turned ON/OFF while the DS-6121/DS-6121A is turned ON. This is not malfunction.

Caution

- When changing the switch setting of RS-232-C, turn the power switch OFF, reset and turn it ON.
- When changing connection of RS-232-C connector and the external equipment and when mounting or dismounting of RS-232-C unit, check if the power switches of DS-6121/DS-6121A and the external equipment are turned OFF before doing so.
- When connecting with the SR-6602 While the DS-6121/DS-6121A is operating, turn the plotter ON or OFF. Otherwise plotting may stop.

5-6 PROGRAM FLOW OF THE DS-6121/DS-6121A BY THE CONTROLLER

Described below is the standard procedures for controlling the DS-6121/DS-6121A via RS-232-C interface.

Writing Waveform Data to DS-6121/DS-6121A

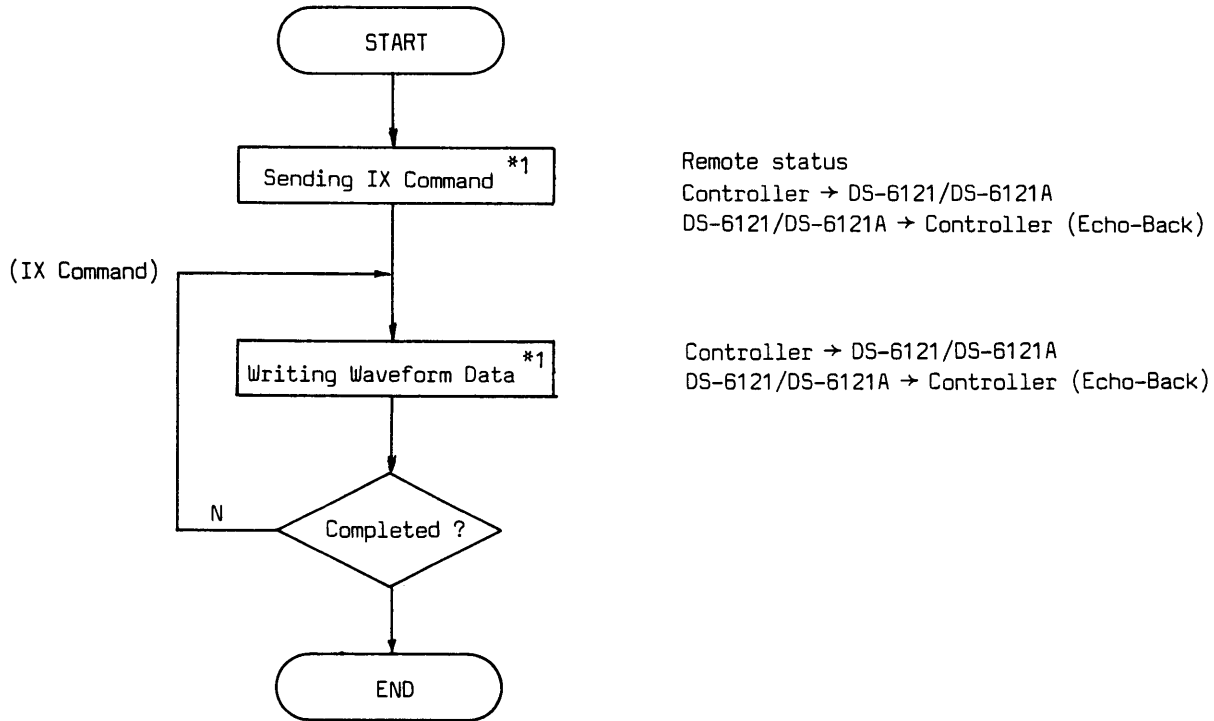

*1 Reform echo-back process character by character.

Read-out of Waveform Data from DS-6121/DS-6121A

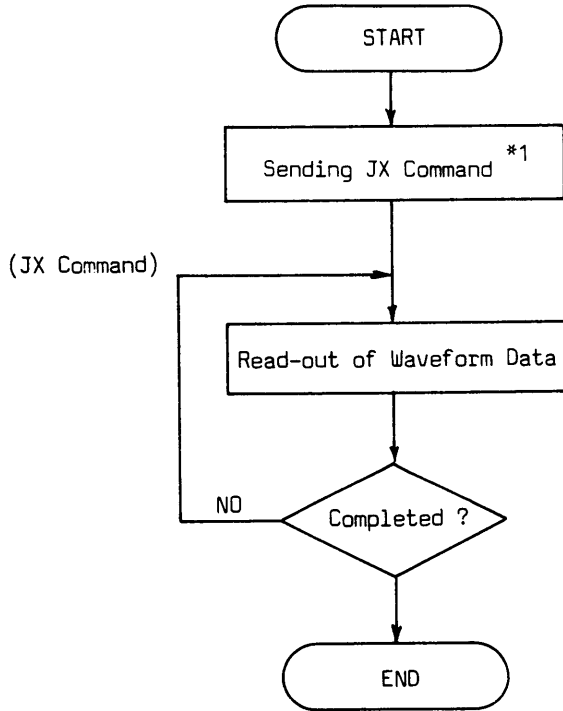

Remote status
Controller → DS-6121/DS-6121A
DS-6121/DS-6121A → Controller (Echo-Back)

DS-6121/DS-6121A

One Command Processing

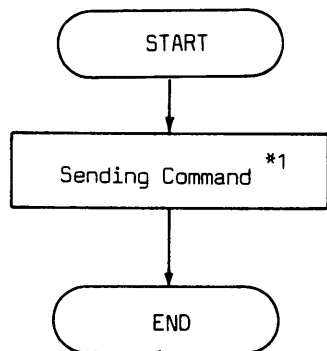

Remote status
Controller → DS-6121/DS-6121A
DS-6121/DS-6121A → Controller (Echo-Back)

*1 Reform echo-back process character by character.

5-7 SAMPLE PROGRAM

Describes two sample programs that use the PC-9801 and HP-216 as external controller.

Overall Operations

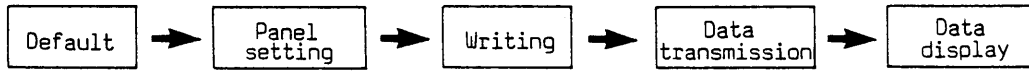

Caution

Switches Setting of PC-9801

When using PC-9801, set the switches as follows:

- Memory switches

SW1	Stop bit	} Optional
	Parity enable	
	Parity sense	
SW2	Full dual	} Fixed
	X parameter disable	
SW2	Baud rate	} Fixed
	S parameter disable	
	Return + Line feed at CR LF reception	

- DIP switches on rear panel

SW1 Internal trigger

5-7-1 PC-9801

```
10 :
20 :
30 :
40 :
50 CONSOLE 0.25.0.1
60 CLS 3
70 :
100 DIM CH1DATA%(2047),CH2DATA%(2047),CH1AUX$(11),CH2AUX$(11)
110 :
120 OPEN "COM:E83NN" AS #1
130 :
200 P$="STU 1.7"
210 GOSUB *SUB
220 GOSUB *CH1SET
230 GOSUB *CH2SET
240 GOSUB *TRGSET
250 GOSUB *TIMESET
260 GOSUB *STRSET
270 GOSUB *WRISUB
280 GOSUB *AUXRD
290 GOSUB *CH1READ
300 GOSUB *CH2READ
310 GOSUB *WAVEDISP
320 CLOSE
330 STOP
400 :
410 *CH1READ
420   P$="JX M10.1.2.0"
430   GOSUB *SUB
440   FOR NUMB%=0 TO 2047
450     LINE INPUT #1,CH1DATA$
455     CH1DATA%(NUMB%)=VAL(CH1DATA$)
460   NEXT NUMB%
470   RETURN
500 :
510 *CH2READ
520   P$="JX M11.1.2.0"
530   GOSUB *SUB
540   FOR NUMB%=0 TO 2047
550     LINE INPUT #1,CH2DATA$
555     CH2DATA%(NUMB%)=VAL(CH2DATA$)
560   NEXT NUMB%
570   RETURN
600 :
610 *CH1SET
620   P$="C1R 6"
630   GOSUB *SUB
640   P$="C1C 2"
650   GOSUB *SUB
660   P$="PS1 0"
670   GOSUB *SUB
680   RETURN
```

Comment

120 Sets parity enable, data length and stop bit.

Parity Eanble (Even)

Data length 8 bits

Stop bit 2 bits

200 and 210 Recall DEFAULT setting by using SET RECALL/SAVE.

400 to 470 CH1 READ

2 kW data which is written from CH 1 of the instrument is transmitted to an array declared by Ch 1 data of the controller.

500 to 570 CH2 READ

2 kW data which is written from CH 2 of the instrument is transmitted to an array declared by Ch 2 data of the controller.

600 to 680 CH1 SET

Settings related to CH 1 amplifier.

VOLTS/DIV 50 mV/div

Coupling DC

Position Midrange

```
700 .
710 *CH2SET
720   P$="C2R 8"
730   GOSUB *SUB
740   P$="C2C 2"
750   GOSUB *SUB
760   P$="PS2 0"
770   GOSUB *SUB
780   P$="C2P 1"
790   GOSUB *SUB
800   RETURN
900 .
910 *TRGSET
920   P$="TAS 2"
930   GOSUB *SUB
940   P$="ATP 1"
950   GOSUB *SUB
960   P$="ATL 10"
970   GOSUB *SUB
980   RETURN
1000 .
1010 *TIMESET
1020   P$="ATD 16"
1030   GOSUB *SUB
1040   RETURN
1050 .
1060 *STRSET
1070   P$="OPM 3"
1080   GOSUB *SUB
1090   P$="MES 1"
1100   GOSUB *SUB
1110   P$="DTP 2"
1120   GOSUB *SUB
1130   RETURN
1150 .
1160 *WRTSUB
1170   P$="RST"
1180   GOSUB *SUB
1185   FOR I%=0 TO 1000 : NEXT I%
1190   RETURN
1250 .
1260 *AUXRD
1270   P$="JX M10.7"
1280   GOSUB *SUB
1290   FOR NUMB%=0 TO 11
1300     LINE INPUT #1.CH1AUX$(NUMB%)
1310   NEXT NUMB%
1320   P$="JX M11.7"
1330   GOSUB *SUB
1340   FOR NUMB%=0 TO 11
1350     LINE INPUT #1.CH2AUX$(NUMB%)
1360   NEXT NUMB%
1370   RETURN
```

Comment

700 to 800 CH2 SET

Settings related to CH 2 amplifier.

VOLTS/DIV	0.2 V/div
Coupling	DC
Position	Midrange
Polarity	INVERT

900 to 980 TRG SET

Settings related to trigger.

A trigger source	CH 2
A trigger slope	-
A trigger level	10%

1000 to 1040 TIME SET

Settings related to time axis.

A TIME/div	0.1 ms/div
------------	------------

1050 to 1130 Strset

Changes the instrument to storage mode, sets DATA POSITION to CENT and SWEEP MODE to single.

1150 to 1190 WRTSUB

Sets the instrument to single reset. This instruction makes this unit a trigger wait state. When triggered, writing is started.

1250 to 1370 AUXRD

Reads out auxiliary information.

```

1400 '
1410 *WAVEDISP
1420 SCREEN 3.0
1430 CLS 3
1440 GOSUB *MEASUR
1450 GOSUB *PRNAUX
1460 FOR X%=0 TO 2047 STEP 4
1470   CH1Y%=(CH1DATA%(X%)/256-129)*(-1)
1480   PSET ((X%+1)/4+62,CH1Y%).2
1490 NEXT X%
1500 FOR X%=0 TO 2047 STEP 4
1510   CH2Y%=(CH2DATA%(X%)/256-129)*(-1)
1520   PSET ((X%+1)/4+62,CH2Y%).1
1530 NEXT X%
1540 RETURN
1600 '
1610 *MEASUR
1620 LINE(63.0)-(575.257).7.B
1630 LINE(63.128)-(575.128).7
1640 '
1650 FOR I%=115 TO 523 STEP 51 : LINE(I%.0)-(I%.9).7 : NEXT I%
1660 FOR I%=115 TO 523 STEP 51 : LINE(I%.118)-(I%.138).7 : NEXT I%
1670 FOR I%=115 TO 523 STEP 51 : LINE(I%.257)-(I%.247).7 : NEXT I%
1680 '
1690 FOR I%=28 TO 231 STEP 25 : LINE(63.I%)-(73.I%).7 : NEXT I%
1700 FOR I%=28 TO 231 STEP 25 : LINE(575.I%)-(565.I%).7 : NEXT I%
1710 RETURN
1800 '
1810 *PRNAUX
1820 LOCATE 10,16 : PRINT "**** AUXILIARY INFORMATION ****"
1830 PRINT "CH1 : " : FOR NUMB%=0 TO 11 : PRINT CH1AUX$(NUMB%)+ " " : NEXT N
UMB%
1840 LOCATE 0,19
1850 PRINT "CH2 : " : FOR NUMB%=0 TO 11 : PRINT CH2AUX$(NUMB%)+ " " : NEXT N
UMB%
1860 COLOR@(0.17)-(79.18).2
1870 COLOR@(0.19)-(79.20).1
1880 RETURN
1900 '
1910 *SUB
1920 D$=""
1930 CNUMB%=LEN(P$)
1940 FOR I%=1 TO CNUMB%+2
1950   IF I%=CNUMB%+1 THEN PRINT #1,CHR$(13);
1960   IF I%=CNUMB%+2 THEN PRINT #1,CHR$(10);
1970   IF I%<=CNUMB% THEN PRINT #1,MID$(P$,I%,1);
1980   D$=D$+INPUT$(1, #1)
1990 NEXT I%
2000 IF P$<>LEFT$(D$,CNUMB%) THEN GOTO *SUB
2010 RETURN
2100 '
2110 END

```

Comment

1400 to 1540 WAVEDISP

Waveforms are displayed based on the data stored in the arrays Ch 1 data and Ch 2 data.

1950 to 1960 Sets delimiter
Delimiter CR LF

5-7-2 HP-216

```

10      !
20      !
30      !
40      !
50      GRAPHICS OFF
100     ASSIGN @Rs232c TO 9
110     DIM String1$(16384) BUFFER
115     DIM String2$(16384) BUFFER
120     INTEGER Ch1data(2047)
130     INTEGER Ch2data(2047)
140     !
150     CONTROL 9,1;0
160     CONTROL 9,3;9600
170     CONTROL 9,4;31
175     CONTROL 9,5;0
180     !
190     ON ERROR GOTO Error
200     !
210     P#="S(U 1,7)"
220     GOSUB Subr
240     GOSUB Ch1set
250     GOSUB Ch2set
260     GOSUB Inget
270     GOSUB Timeset
280     GOSUB Strset
290     GOSUB Prtsub
300     GOSUB Award
310     GOSUB Ch1read
320     GOSUB Ch2read
330     GOSUB Wavedisp
340     STOP
400     !
410     Ch1read:      !
420         P#="3X H10,1,2,0"
430         GOSUB Subr
440         ASSIGN @Buff TO BUFFER String1$
445         TRANSFER @Rs232c TO @Buff
450         ASSIGN @Buff TO *
460         FOR I=1 TO 16384 STEP 8
465             FOR J=0 TO 7
470                 IF String1$(I+J;1)=CHR$(32) THEN String1$(I+3;1)=CHR$(48)
475             NEXT J
480             Ch1data(I DIV 8)=VAL(String1$(I;6))
485         NEXT I
490         RETURN

```

Comment

160 Sets baud rate
 Baud rate 9600 BPS
170 Sets parity enable, data length and stop bit.
 Parity Enable (Even)
 Data length 8 bits
 Stop bit 2 bits
210 and 220 Recall DEFAULT setting by using SET RECALL/SAVE

400 to 470 Ch 1 read
 2 kW data which is written from CH 1 of the instrument is transmitted to an array declared
 by Ch 1 data of the controller.

```
500      !
510 Ch2read:      !
520          P#="JX M11,1,2,0"
530          GOSUB Subr
540          ASSIGN @Buff TO BUFFER String2#
545          TRANSFER @Rs232c TO @Buff
550          ASSIGN @Buff TO *
560          FOR I=1 TO 16384 STEP 8
565              FOR J=0 TO 7
570                  IF String2#[I+J;1]=CHR$(32) THEN String2#[I+J;1]=CHR$(48)
575              NEXT J
580              Ch2data(I DIV 8)=VAL(String2#[I;6])
585          NEXT I
590          RETURN
600      !
610 Ch1set:      !
620          P#="C1R 2"
630          GOSUB Subr
640          P#="C1C 2"
645          GOSUB Subr
650          P#="PS1 0"
655          GOSUB Subr
660          RETURN
670      !
680 Ch2set:      !
690          P#="C2R 2"
700          GOSUB Subr
710          P#="C2C 2"
715          GOSUB Subr
720          P#="PS2 0"
725          GOSUB Subr
730          P#="C2P 1"
735          GOSUB Subr
740          RETURN
750      !
760 Trgset:      !
770          P#="TAS 2"
775          GOSUB Subr
780          P#="ATP 1"
785          GOSUB Subr
790          P#="ATL 10"
795          GOSUB Subr
800          RETURN
810      !
820 Timeset:      !
830          P#="ATD 16"
835          GOSUB Subr
840          RETURN
```

Comment

500 to 570 Ch 1 read
2 kW data which is written from CH 2 of the instrument is transmitted to an array declared by Ch 2 data of the controller.

600 to 710 Ch 1 set
Settings related to CH 1 amplifier.
VOLTS/DIV 50 mV/div
Coupling DC
Position CENTER

800 to 940 Ch 2 set
Settings related to CH 2 amplifier.
VOLTS/DIV 0.2 V/div
Coupling DC
Position CENTER
Polarity INVERT

1000 to 1110 Trg set
Settings related to trigger.
A trigger source CH 2
A trigger slope -
A trigger level 10%

1200 to 1250 Time set
Settings related to time axis.
A TIME/div 0.1 ms/div

```

1300 !
1310 Strsel: !
1320     P#="OPM 3"
1330     GOSUB Subr
1350     P#="MES 1"
1360     GOSUB Subr
1380     P#="DTP 2"
1390     GOSUB Subr
1410     RETURN
1500 !
1510 Wrtsub: !
1520     P#="RS1"
1530     GOSUB Subr
1560     WAIT 1
1570     RETURN
1600 !
1610 Auxrd: !
1620     P#="JX M10,7"
1630     GOSUB Subr
1650     FOR I=0 TO 11
1653         J=0
1657         J=J+1
1660         ENTER @Rs232c USING "#,A";Chiaux#[I];1]
1665         IF Chiaux#[I];1]<>CHR$(10) THEN GOTO 1657
1670         PRINT Chiaux#[I];J-2]
1680     NEXT I
1690     WAIT .5
1700     P#="JX M11,7"
1710     GOSUB Subr
1730     FOR I=0 TO 11
1733         J=0
1737         J=J+1
1740         ENTER @Rs232c USING "#,A";Ch2aux#[I];1]
1745         IF Ch2aux#[I];1]<>CHR$(10) THEN GOTO 1737
1750         PRINT Ch2aux#[I];J-2]
1760     NEXT I
1770     RETURN
1800 Wavedisp: !
1810     GRAPHICS ON
1820     WINDOW 0,2047,-256,256
1830     VIEWPORT 0,400,0,200
1840     MOVE 0,0
1850     FOR I=0 TO 2047
1860         Ch1d=Ch1data(I)/256+128
1870         PLOT I,Ch1d
1890     NEXT I
1890     MOVE 0,0
1900     FOR I=0 TO 2047
1910         Ch2d=Ch2data(I)/256*(-1)-128
1920         PLOT I,Ch2d
1930     NEXT I
1940     RETURN

```

Comment

1300 to 1410 Strset

Changes this unit to storage mode and sets the operation mode to single.

1500 to 1570 Wrtsub

Sets single reset to the instrument. This instruction makes this unit a trigger wait state. When triggered, writing is started and finished.

1600 to 1770 Auxrd

Reads out auxiliary information.

1800 to 1940 Wavedisp

Waveforms are displayed based on the data stored in the arrays Ch 1 data and Ch 2 data.

```
2000  !
2010 Error:  !
2020      IF ERRN<>167 THEN PRINT "error <>167"
2030      STATUS 9,10;Uart
2040      IF BIT(Uart,1) THEN PRINT "Overrun error"
2050      IF BIT(Uart,2) THEN PRINT "Parity error"
2060      IF BIT(Uart,3) THEN PRINT "Framing error"
2070      IF BIT(Uart,4) THEN PRINT "BREAK received"
2080      IF BIT(Uart,5) THEN PRINT "T.H.Register empty"
2090      IF BIT(Uart,6) THEN PRINT "T.S.Register empty"
2100      STOP
2300  !
2310 Subr:  !
2315      D$=""
2320      Cnumb=LEN(P$)
2325      FOR I=1 TO Cnumb+2
2330          IF I=Cnumb+2 THEN OUTPUT @Rs232c;CHR$(10);
2360          IF I=Cnumb+1 THEN OUTPUT @Rs232c;CHR$(13);
2390          IF I<=Cnumb THEN OUTPUT @Rs232c;P$(I);
2430          ENTER @Rs232c USING "#,A";D$(I);
2470      NEXT I
2480      IF P$<>D$(1;Cnumb) THEN GOTO 2315
2490      RETURN
2500  END
```

Comment

2330 to 2360 Sets delimiter
Delimiter CR LF

MEMO

MANUAL SHEET (I) for DS-6121

GUIDE MENU TREE

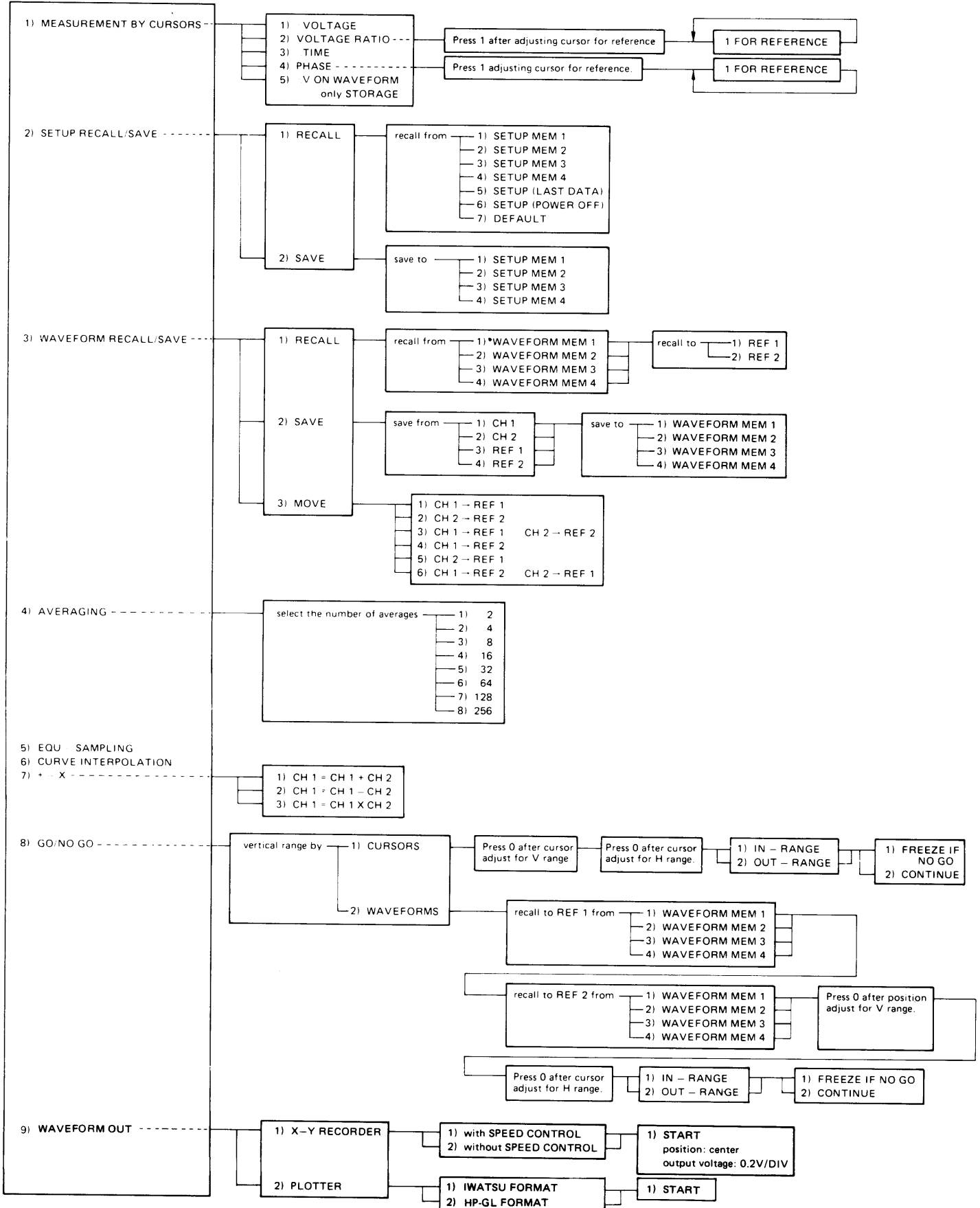

MANUAL SHEET (I) for DS-6121

1. Available TIME/DIV in Each Function

TIME/DIV	EXT	0.2s	0.5ms	2μs	20ns
STORAGE OFF (REAL)		0.1s			
STORAGE OFF (ROLL)	10s	0.2s			
STORAGE ON					
EQU-SAMPLING 1 channel				2μs	
EQU-SAMPLING 2 channels				5μs	

2. List of functions which can be selected in combination

The following table shows whether or not a particular F1 MENU item can be selected simultaneously with a particular F2 item.

		F2								
		1) MEASUREMENT BY CURSORS	2) SETUP RECALL/SAVE	3) WAVEFORM RECALL/SAVE	4) AVERAGING	5) EQU-SAMPLING	6) CURVE INTERPOLATION	7) + - X	8) GO/NO GO	9) WAVEFORM OUT
F1	1) MEASUREMENT BY CURSORS									
	2) SETUP RECALL/SAVE									
	3) WAVEFORM RECALL/SAVE									
	4) AVERAGING	○	○	○		○	○	○	○	○
	5) EQU-SAMPLING	○	○	○	○		○	○	○	○
	6) CURVE INTERPOLATION	○	○	○	○	○		○	○	○
	7) + - X	○	○	○	○	○	○		○	○
	8) GO/NO GO		○	*1	○	○	○	○		
	9) WAVEFORM OUT									

○ shows that the simultaneous selection is possible.

*1 SAVE can be performed simultaneously but RECALL should be performed with other modes.

3. Note on key

-  key is used for clearing FUNCTION selected from GUIDE MENU.

Selecting multiple FUNCTIONS from GUIDE MENU and pressing  after completion of operating, all FUNCTIONS is cleared.

Selecting multiple FUNCTIONS from GUIDE MENU and pressing  during operating, only one FUNCTION selected last is cleared.

- Clearing a particular FUNCTION find its (OFF) display in GUIDE MENU and press the relevant numerical key with the corresponding function number.

 IWATSU ELECTRIC CO., LTD.

YANAGIYA BLDG, 1-10, NIHONBASHI 2-CHOME, CHUO-KU,
TOKYO, 103 JAPAN TEL: TOKYO (271) 5131 FAX: TOKYO (271) 1554
CABLE ADDRESS: TELEPHIWATSU TELEX: J24225 TELEIWA

MANUAL SHEET (I) for DS-6121A

GUIDE MENU TREE

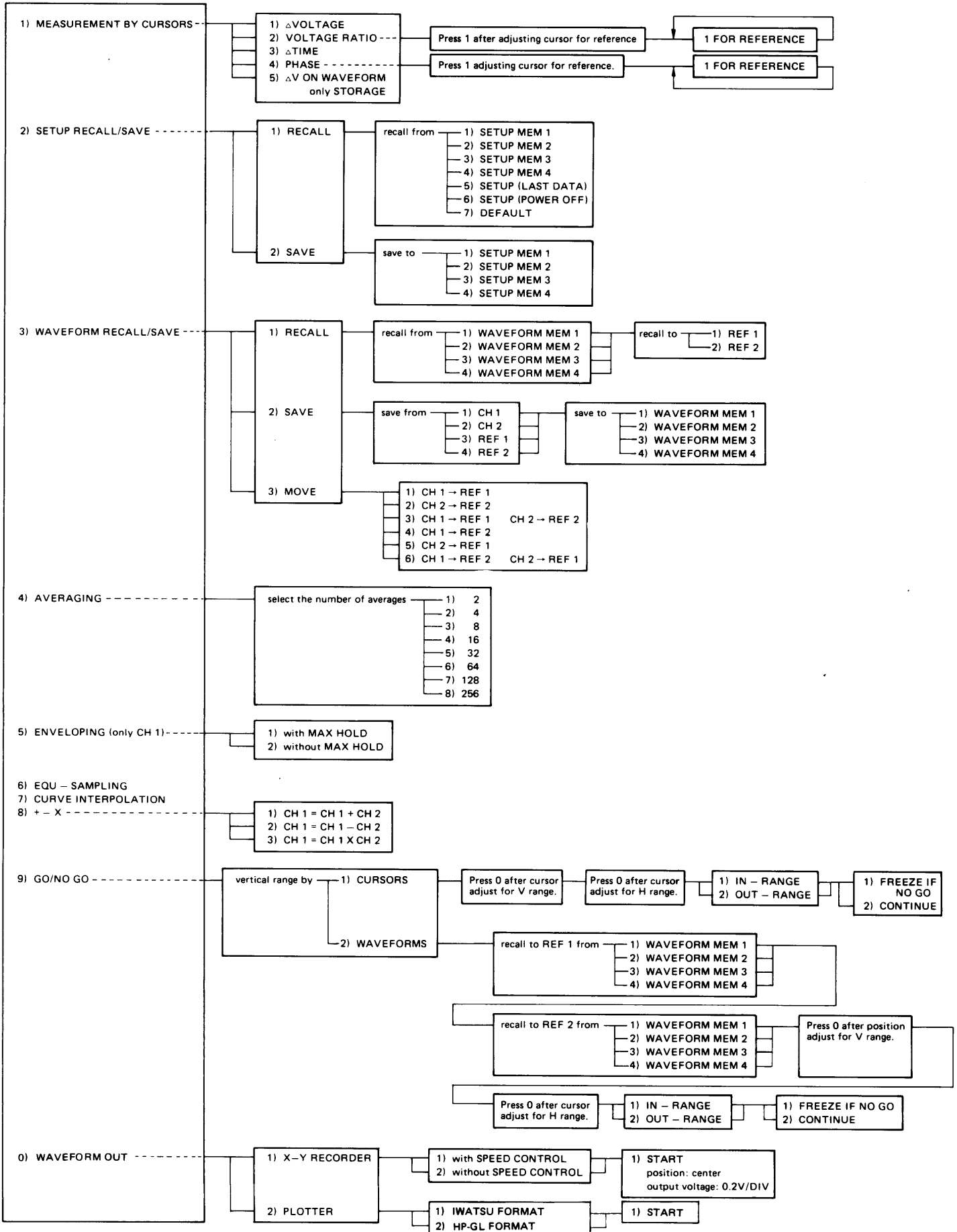

MANUAL SHEET (I) for DS-6121A

1. Available TIME/DIV in Each Function

TIME/DIV.	EXT.	2 μ s	0.5ms	0.2s	20ns
Function					
STORAGE OFF (REAL)		0.1s			
STORAGE OFF (ROLL)	10s	0.2s			
STORAGE ON					
EQU-SAMPLING 1 channel				2 μ s	
EQU-SAMPLING 2 channels				5 μ s	
ENVELOPING					

2. List of functions which can be selected in combination

The following table shows whether or not a particular F1 MENU item can be selected simultaneously with a particular F2 item.

		F2										
		1) MEASUREMENT BY CURSORS	2) SETUP RECALL/SAVE	3) WAVEFORM RECALL/SAVE	4) AVERAGING	5) ENVELOPING	6) EQU-SAMPLING	7) CURVE INTERPOLATION	8) + - X	9) GO/NO GO	0) WAVEFORM OUT	
F1	1) MEASUREMENT BY CURSORS											
	2) SETUP RECALL/SAVE											
	3) WAVEFORM RECALL/SAVE											
	4) AVERAGING											
	5) ENVELOPING											
	6) EQU-SAMPLING											
	7) CURVE INTERPOLATION											
	8) + - X											
	9) GO/NO GO											
	0) WAVEFORM OUT											

○ shows that the simultaneous selection is possible.

*1 SAVE can be performed simultaneously but RECALL should be performed with other modes.

3. Note on key

-  key is used for clearing FUNCTION selected from GUIDE MENU.

Selecting multiple FUNCTIONS from GUIDE MENU and pressing  after completion of operating, all FUNCTIONS is cleared.

Selecting multiple FUNCTIONS from GUIDE MENU and pressing  during operating, only one FUNCTION selected last is cleared.

- Clearing a particular FUNCTION find its (OFF) display in GUIDE MENU and press the relevant numerical key with the corresponding function number.

 IWATSU ELECTRIC CO., LTD.

YANAGIYA BLDG, 1-10, NIHONBASHI 2-CHOME, CHUO-KU,
TOKYO, 103 JAPAN TEL: TOKYO (271) 5131 FAX: TOKYO (271) 1554
CABLE ADDRESS: TELEPHIWATSU TELEX: J24225 TELEIWA